

Γενικός κατάλογος
ΠΡΟΪΟΝΤΩΝ
2023-2024



www.patco.gr



Δυνατά & Αξιόπιστα

Ολοκληρωμένη σειρά
χειροποίητων
αγροτικών εργαλείων
PATCO



“ Η εμπιστοσύνη σας
είναι η δύναμή μας
για να συνεχίσουμε ”



Αγαπητοί συνεργάτες,

Ο ανανεωμένος κατάλογος που έχετε στα χέρια σας συγκεντρώνει όλη την επιχειρηματική μας διαδρομή και αποτελεί ένα εργαλείο το οποίο θα συμβάλει σημαντικά στην ανάπτυξη της επιχείρησής σας.

Εδώ και 35 χρόνια έχουμε αναπτύξει ισχυρές βάσεις για τη βέλτιστη εξυπηρέτηση των καταστημάτων βιομηχανικού και τεχνικού εξοπλισμού.

Μια σειρά κρίσεων το τελευταίο χρονικό διάστημα επηρέασαν σημαντικά τη παγκόσμια αγορά και φυσικά είχαν σημαντικές επιπτώσεις και στην εγχώρια αγορά.

Εμείς όλο αυτό το διάστημα προσπαθήσαμε και καταφέραμε να σταθούμε σταθερά δίπλα στους συνεργάτες μας επεκτείνοντας διαρκώς τη γκάμα των προϊόντων μας διαθέτοντας πάνω από 10000 κωδικούς προϊόντων σε περισσότερα από 250 brands, αυξάνοντας συνειδητά τα αποθέματά μας και επενδύοντας σε νέο ανθρώπινο δυναμικό αποτελώντας έτσι βασική επιλογή για τους συνεργάτες μας σε όλη την Ελλάδα.

Στόχος μας είναι πάντοτε η άμεση και βέλτιστη εξυπηρέτηση της επαγγελματικής σας δραστηριότητας μέσω της προμήθειας ανταγωνιστικών προϊόντων ευρείας γκάμας, ενώ ταυτόχρονα επιζητούμε πάντοτε την εντιμότητα και την ειλικρίνεια, ώστε να διασφαλίζουμε μακροχρόνιες συνεργασίες με τους πελάτες και τους προμηθευτές μας.

Στη προσπάθειά μας αυτή είναι πολύ σημαντική η συμμετοχή των ανθρώπων μας στις ομάδες πωλήσεων και τα υποστηρικτικά τμήματα, οι οποίοι με την άρτια κατάρτισή τους είναι διαρκώς στο πλευρό σας για άμεση ανταπόκριση και εξυπηρέτηση.

Θα ήθελα να σας ευχαριστήσω για την εμπιστοσύνη που δείχνετε όλα αυτά τα χρόνια στην εταιρεία μας και επί τη ευκαιρία να καλωσορίσω όλους τους νέους συνεργάτες που θα επιλέξουν να ενταχθούν στην μεγάλη επιχειρηματική μας οικογένεια.

Γεώργιος Βλάχος



Δίπλα στον επαγγελματία πάνω από **30 χρόνια**



Καλύτερες τιμές στην αγορά

Πετυχαίνουμε ασυναγώνιστες τιμές, εξασφαλίζοντας τη βέλτιστη σχέση τιμής-ποιότητας



Υψηλή διαθεσιμότητα εμπορευμάτων

Διαθέτουμε πάνω από 10000 κωδικούς με άμεση διαθεσιμότητα και επεκτείνουμε διαρκώς το κωδικολόγιο μας



Έγκαιρη αποστολή παραγγελιών

Εξασφαλίζουμε την άμεση αποστολή των εμπορευμάτων χωρίς λάθη και αστοχίες με το μεγαλύτερο μέρος των παραγγελιών να εκτελείται αυθημερόν

Η ΑΦΟΙ ΒΛΑΧΟΥ Ο.Ε. - ΡΑΤΣΟ αποτελεί την πιο ταχέως αναπτυσσόμενη εταιρία εισαγωγών και διανομής εργαλείων χειρός στην Ελλάδα.

Συνδυάζοντας τη μακρόχρονη εμπειρία και οικογενειακή παράδοση, με την κουλτούρα της συνεχούς βελτίωσης, η εταιρία μας εφαρμόζει σύγχρονες μεθόδους διοίκησης, που την καθιστούν πολύτιμο και αξιόπιστο συνεργάτη.

Δραστηριοποιείται στη χονδρική πώληση και διανομή εργαλείων χειρός, απο το 1985.

Μέσα στα χρόνια, διατηρώντας πάντα την προσήλωση στον πελάτη, έχει εξελιχθεί σε έναν απο τους σημαντικότερους Έλληνες προμηθευτές εργαλείων.

Η προμήθεια και διανομή προϊόντων, η τεχνική υποστήριξη και η συμβουλευτική πώληση που προσφέρονται απο την εταιρία μας, συνιστούν μια ολοκληρωμένη πρόταση για τους πελάτες μας, καλύπτοντας ένα ευρύ φάσμα αναγκών.



Πελατολόγιο

Πάνω από 2500 ενεργοί πελάτες έχουν επιλεξει την εταιρία μας



Ο πελάτης στο επίκεντρο

Η εταιρία μας έχει πελατοκεντρικό προσανατολισμό, αναπτύσσοντας διαρκώς διαδικασίες και εργαλεία για το σκοπό αυτό



Εξειδικευμένη υποστήριξη

Οι εξωτερικοί και εσωτερικοί πωλητές μας είναι πάντα κοντά σας, για να προσφέρουν τεχνική υποστήριξη και γνώση σε οποιαδήποτε απορία σας.

Η ιστορία μας



Ο παππούς των σημερινών ιδιοκτητών, Κωνσταντίνος Βλάχος ξεκινά από ένα μικρό εργαστήριο επισκευής γεωργικών εργαλείων στην Πάτρα.

1920

1985

Ιδρύεται η ΑΦΟΙ ΒΛΑΧΟΥ Ο.Ε. από τους σημερινούς ιδιοκτήτες Γεώργιο και Κωνσταντίνο, με σκοπό την εμπορία γεωργικών εργαλείων και σιδηρικών.

1990

Πραγματοποιούνται οι πρώτες εισαγωγές. Αλλάζει σταδιακά ο τρόπος λειτουργίας και η έδρα της εταιρίας μεταφέρεται σε νέο μεγαλύτερο αποθηκευτικό χώρο.

2006

Γίνεται η εγκατάσταση στις σημερινές ιδιότητες εγκαταστάσεις στη Βιομηχανική Περιοχή της Πάτρας.

2007

Η ΑΦΟΙ ΒΛΑΧΟΥ Ο.Ε. επενδύει στα πληροφοριακά συστήματα και στον τεχνολογικό εξοπλισμό, αποκτώντας το ERP λογισμικό της Singular Logic.

2009

Λανσάρονται στην αγορά τα προϊόντα ιδιωτικής ετικέτας PATCO.

Η εταιρία δραστηριοποιείται στον εμπορικό στίβο για πάνω από 30 χρόνια, έχοντας μακρά παράδοση στο χώρο των σιδηρικών και γεωργικών εργαλείων.

Οι ρίζες της προέρχονται από την παράδοση της οικογένειας των ιδιοκτητών, που συνεχίζεται μέχρι και σήμερα.

Το όραμά μας είναι να είμαστε ο προμηθευτής ηγέτης αγροτικών και σιδηρικών εργαλείων στην ελληνική αγορά, συνεισφέροντας στην κοινωνική και οικονομική ανάπτυξη.

Χτίζουμε μακροχρόνιες σχέσεις με τους πελάτες μας και προσφέρουμε ποιοτικές υπηρεσίες που ξεπερνούν τις προσδοκίες της αγοράς.

Αναπτύσσουμε το πελατολόγιο μας και ενισχύουμε την κουλτούρα αμοιβαίου οφέλους μέσω της επαγγελματικής μας πρότασης. Οι άνθρωποί μας στο τμήμα πωλήσεων κάνουν χιλιάδες χιλιόμετρα για να βρεθούν κοντά σας, διερευνούν τις ανάγκες της αγοράς και συστήνουν προτάσεις συνεργασίας αμοιβαίου οφέλους.



Σχετικά με εμάς

Οι πελάτες μας επωφελούνται από την τεχνογνωσία και τις υψηλού επιπέδου υπηρεσίες μας.

Η πρότασή μας στην αγορά περιλαμβάνει είδη τεχνικού εξοπλισμού όπως: εργαλεία χειρός και αναλώσιμα, αγροτικά εργαλεία, ηλεκτρικά εργαλεία, εργαλεία κήπου, εργαλεία βαφής - σπρέι, συγκολλητικά, κλειδαριές και λουκέτα, είδη προστασίας/ασφαλείας.

Η μακροχρόνια συνεργασία μας με καταξιωμένους οίκους του εξωτερικού εξασφαλίζει την διάθεση αναγνωρισμένων και ταχυκίνητων κωδικών οι οποίοι αποτελούν τον κορμό των καταστημάτων λιανικής.

Επίσης μια σειρά κωδικών που καλύπτουν και τις πιο εξειδικευμένες ανάγκες υπάρχει για να ικανοποιήσει και τους πιο απαιτητικούς.

ΟΙ ΣΥΝΕΡΓΑΤΕΣ ΜΑΣ:

- ▶ σιδηροπωλεία
- ▶ γεωπονικά καταστήματα
- ▶ χρωματοπωλεία
- ▶ τεχνικά πολυκαταστήματα
- ▶ καταστήματα με είδη κιγκαλερίας
- ▶ καταστήματα με βιομηχανικά εργαλεία

2011

Η επένδυση συνεχίζεται, αποκτώντας πλέον το WMS της MANTIS με γνώμονα την αποδοτικότερη λειτουργία του κέντρου διανομής μας.

2017

Βράβευση της εταιρίας μας από την EINHELL HELLAS ως χονδρέμπορος με τη μεγαλύτερη ανάπτυξη.

2018

Ξεκινούν οι εργασίες για επέκταση των ιδιόκτητων αποθηκευτικών χώρων στη Βιομηχανική Περιοχή της Πάτρας.

2019

Ολοκλήρωση εργασιών επέκτασης εγκαταστάσεων.

2020
έως
2022

Διαρκής ανάπτυξη δικτύου διανομής. Επέκταση ομάδας πωλήσεων

2023

Συμφωνία ανανέωσης συστημάτων ERP και δημιουργίας B2B. Περαιτέρω επέκταση της δραστηριότητας για την προμήθεια και διανομή ηλεκτρικών εργαλείων και μηχανημάτων

Η Ομάδα μας!



Η επιλογή των πελατών μας να συνεργαστούν μαζί μας και η διάθεσή τους να μας επιλέγουν σταθερά σαν έναν μακροχρόνιο προμηθευτή των καταστημάτων τους, στηρίζεται στους βασικούς πυλώνες της εμπιστοσύνης και συνέπειας που απολαμβάνουν. Η προσήλωση στις ανάγκες της αγοράς, η άριστη τεχνική γνώση των εργαλείων, καθώς και η ευελιξία, χαρακτηρίζουν τον τρόπο που λειτουργούμε.

Η αφοσίωση και το πάθος που επιδεικνύουν όλοι οι άνθρωποί μας, προσθέτουν επιπλέον αξία στην επαγγελματική μας πρόταση. Δημιουργικοί, τεχνικά καταρτισμένοι, πελατοκεντρικοί, χαρούμενοι και αποτελεσματικοί, οι άνθρωποι της εταιρίας μας είναι πλέον μια οικογένεια! Οι άνθρωποί μας στο customer service πάντα πρόθυμοι και έτοιμοι να μιλήσουν μαζί σας, εγγυώνται την άμεση εξυπηρέτηση και δίνουν λύση σε κάθε ζήτημα. Στην προετοιμασία και αποστολή των παραγγελιών, φροντίζουν πάντα με υπευθυνότητα, για την ασφαλή και χωρίς αστοχίες παράδοση των εμπορευμάτων σας.

Γιατί μας επιλέγετε

Η εταιρεία Patco αποτελεί την πρώτη και συνειδητή επιλογή του επαγγελματία για τεχνικό και βιομηχανικό εξοπλισμό.

- ▶ Ολοκληρωμένες λύσεις – ποικιλία προϊόντων για την κάλυψη των αναγκών του καταστήματός σας
- ▶ Συμβουλευτική υπηρεσία αναβάθμισης καταστήματος.
- ▶ Μακροχρόνιες σχέσεις και συνεργασίες που ξεπερνούν τις προσδοκίες της αγοράς.
- ▶ 100% Διαθεσιμότητα προϊόντων.
- ▶ Άμεση εξυπηρέτηση και παράδοση των παραγγελιών σας
- ▶ Ανταγωνιστικές τιμές.
- ▶ Στήριξη καταστημάτων με βλέμμα προς το μέλλον.

Προϊόν	Σελίδα
A	
Αγκιστρα	419, 420
Αγκιστρα Tesa	465
Αγκιστρα με παξιμάδι	200
Αδιαβροχοποιητικό επιφανειών	281
Αεροθάλαμοι	120
Αεροπλανάκι	387
Αεροπλάστ	446
Αεροστόπ	475, 476
Αεροσώλωμα	215
Αεροκάρτ	446
Ακόνια	316
Ακονιστήρια	317
Ακροδέκτες με καλώδια	370
Άλλεν κλειδιά	161
Αλοιφές γυαλισματος	311, 359
Αλουμίνιο φωτιάς	290
Αλουμινοταινίες	458, 467, 470
Αλυσίδες	418
Αλυσίδες σκύλων	499
Αλυσοπρίνο μπαταρίας	051
Αλφάδια	122
Αλφαδολάστικα	123
Αμόνι κόσας	022
Αναδευτήρες	235, 236
Αναμοχλευτής κήπου	008
Αναρτήρες ντουλαπιών	374
Ανέμες λάστιχων	067
Αντάπτορας βάσης λείανσης	364
Αντάπτορες για καρυδάκια (σετ)	163
Αντάπτορες καστανίας	164
Αντάπτορες μυτών	168
Αντάπτορες σούκο	365
Αντικρούσματα	401, 402
Αντισκωριακά	291, 306, 310
Αντλίες υγρών	130
Αξίνες	001-008
Αξινοκασμάδες	008
Αποστραγγιστική μεμβράνη	442
Αποφρακτήρας	130
Απωθητικά περιστεριών	493
Ασετόν	293
Αστάρια	281, 287, 288, 292
Ασφάλειες ανοιγ.-συρόμενων	402
Ασφάλειες αρότρου	206
Ατέρμονες ψισταριάς	504
Ατσαλίνες ηλεκτρολόγων	370
Ατσαλίνες υδραυλικών	130
Ατσαλόκαρφα	216, 217
Ατσαλόμαλλο	447
Αυλοί ψεκαστήρων	087
Αφαιρετικό χρωμάτων	304
Αφροί πολυουρεθάνης	249, 250, 266, 267
Αφροί πολυστερίνης	266
B	
Βαλτσάκι δραπεάνου	156
Βαριές	094, 095
Βαριοπούλες	094
Βάσεις εξαρτημάτων λείανσης	361-363
Βάσεις πέργκολας	429
Βάσεις τηλεόρασης	478

Προϊόν	Σελίδα
Βάση ράουλου	383
Βάση συρόμενης πόρτας	380
Βατοκόπες	019
Βελατούρα	288
Βελόνια	098, 099
Βελόνια SDS PLUS	179
Βέργες γρύλων	417
Βέργες κουρτίνας μπάνιου	477
Βέργες πόρτας	465, 475, 476
Βερνίκια – βερνικοχρώματα	288, 289
Βίδες	185-199
Βιδοθηλιές	204, 205
Βίτζια	423
Βούρσα πατώματος	449
Βούρτσες καμινάδας	516
Βούρτσες πλυσίματος	078
Βρύσες γαλβανιζέ	489
Βρύσες διακοσμητικές	131
Γ	
Γάζες Ρωγμών	466
Γαλότσες	563-564
Γάντζοι	205, 425
Γάντζοι ανύψωσης	422
Γάντζος τζακιού	513
Γάντια	536-546
Γάντια ηλεκτροσυγκολλητών	146
Γάντια μιας χρήσεως	544-546
Γερμανικά κλειδιά	158, 159
Γερμανοπλύγωνα κλειδιά	159, 160
Γεωτρύπανα	025
Γιλέκα ανακλαστικά	535
Γκαζάκια καφέ	137
Γκρόβερ	211, 212
Γλουτολίνες	283
Γλωσσίδα κουδουνιών	494
Γράβαλα ελαιών – σταφίδας	035
Γράβαλο κήπου	008
Γραμματοκιβώτια	478
Γρανάζια σουβλάς	504
Γράσα	312
Γρασαδόροι και εξαρτήματα	313
Γρύλοι	417
Γρύλοι αυτοκινήτων	162
Γρυλοπόμολο	417
Γρυλόκερα	416
Γυαλιά ηλεκτροσυγκολλητών	147
Γυαλιά προστασίας	546, 547
Γύψος	285
Γωνιά τελαρώματος	433
Γωνιές γαλβανιζέ	513
Γωνιές εμαγιέ	513
Γωνιές επιπλοποιίας – ραφιών	374-376
Γωνιές λουκέτων	413
Γωνιές κτιστών	125
Γωνιές πέργκολας	433, 434
Δ	
Δακτυλίδια σωλήνων σόμπας	515
Δεματικά καλωδίων	373
Δετικά λουλουδιών	040
Διακόπτες νερού σφαιρικοί	132
Διαλυτικά	293, 294

Προϊόν	Σελίδα
Διαμάντια τζαμιών	108
Διασκορπιστές νερού	076
Διαχωρ. φορητών-συρτ/θηκών	521
Δικέλια	026
Δίσκοι γυαλισματος - καθαρισμού	360
Δίσκοι γυαλισματος με πτερύγια	360
Δίσκοι κοπής	322, 323
Δίσκοι λείανσης με πτερύγια	353
Δίσκοι φίμπερ	351, 352
Διχάλες για σουβλά	505
Δίχτυα	442-444
Δοκοθήκες	429, 430
Δόλωμα τρωκτικών	500
Δρεπάνια	019, 020
E	
Εκθετήριο BAHCO μαχαριών	483
Εκθετήριο BELLOTA βελονιών	098
Εκθετήριο BELLOTA λιμών	093
Εκθετήριο BELLOTA ξύλων	063
Εκθετήριο BELLOTA πριονιών	045
Εκθετήριο BELLOTA υποδημάτων	559
Εκθετήριο DEN BRAVEN γόνδολα	248
Εκθετήριο DEN BRAVEN MAMUT σωληνάρια	261
Εκθετήριο DEN BRAVEN MAMUT φυσίγγια	261
Εκθετήριο DEN BRAVEN στενό	248
Εκθετήριο ELASTOTET σπρέι QUANTUM	307
Εκθετήριο ELASTOTET στενό	266
Εκθετήριο EPOCA εργαλείων κήπου	031
Εκθετήριο GF ποτιστικών κολώνα	070
Εκθετήριο GF ποτιστικών τοίκου	070
Εκθετήριο GYS ηλεκτρ/κολλήσεων	143
Εκθετήριο IZAR τρυπανιών	182
Εκθετήριο KDS κόφτες μοκετών	485
Εκθετήριο MACO γυαλιών	546
Εκθετήριο MACO τρυπανιών	182
Εκθετήριο MGI ταινιών	466
Εκθετήριο MIKALOR σφιγκτήρων	081
Εκθετήριο MPS ποτηροτρύπανων	177
Εκθετήριο OSBORN (DRONCO)	317
Εκθετήριο PATCO μαχαριών	479
Εκθετήριο SAPISELCO δεματικών καλωδίων	372
Εκθετήριο SMIRDEX διπλής όψης	324
Εκθετήριο SMIRDEX μονής όψης	324
Ελαιόδιχτα	037
Εντατήρες	421
Εξαρτήματα λείανσης	324-363
Εξαρτήματα πέργκολας	429-435
Επιγονατίδες μαρμαράδων	534
Επιστρωτές μεπετού	107
Εργαλεία κήπου (εκθετ. 140cm)	031
Εργαλεία κήπου(σετ)	030
Εργαλεία σετ σε κασετίνα	160
Εργαλείοθήκες	155, 156
Z	
Ζέβλα	498
Ζουμπάδες	171
Ζουμπάς ατσαλόκαρφων	217
Ζυγαριές	478
Ζύγια	123, 124
Ζυμμιλια	118
Ζώνες στρατιωτικές	534

Προϊόν	Σελίδα
H	
Ηλεκτρόδια	149-151
Ηλεκτροσυγκολλήσεις	140-142
Ητα γαλβανιζέ	514
Ητα εμαγιέ	514
Θ	
Θήκες πριονιών	048, 049
Θηλιές κοσών	024
I	
Ιμάντες ανύψωσης	425
Ιμάντες παραθύρων	477
Ιμάντες πρόσδεσης	424
Ιμάντες σκύλων	499
K	
Κάρο εμαγιέ	515
Καθαριστήρες δαπέδου	107
Καθαριστικό αφρού πιστολιού	250, 268
Καλέμια	098, 099
Καλέμια SDS PLUS	179
Καλύπτρες κεραμιδιών	435
Καλύπτρες τραπεζοειδείς	200
Καλώδια μπαταρίας	370
Καμπανάκια ορειχάλκινα (κυπριά)	496
Καμπανέλες σκύλων	496
Κάνουλες	132, 133
Καντάρια	479
Καπελάκι στριφωنيού	200
Καπέλο καμινάδας	515
Καπιστράνες ζώων	497
Καραβάκι (βούρτσα)	227
Καρδάρες	490
Καρκίνος συρματοσχοινών	422
Καρότσια	118, 119, 121
Καρούλι μπαλάντζας	366
Καρούλια λάστικων	067
Καρτελοθήκες κλειδιών	414
Καρυδάκι Ταφ	163
Καρυδάκια	163
Καρυδάκια κάδρων	220
Καρυδιά δίκαλα	218
Καρυδιά με ροδέλα	217
Καρυφοβελόνες	220
Καρυφωτικό	218
Κασάρες	019
Κασετίνα πλαστική	155
Κασμαδάκι	009, 044
Κασμάδες	008, 009
Καστανιέρα	516
Καστάνιες	164
Καταλύτες σιδηρόστοκου	258
Κατεβάτες	387
Κατσαβίδια	169
Κεραμιδοκόφτης	435
Κεφαλή θαμνοκοπτικού	025
Kit DSL	402
Κλαδευτήρια	021
Κλειδαριές	396-404, 407-411
Κλειδί νιπτήρος	128
Κλειδί πετρογκάζ	138
Κλειδί ρολογιών ύδρευσης OYLEN	128
Κλειδί φίλτρου	162

Προϊόν	Σελίδα
Κλειδιά Άλλεν	161
Κλειδιά γερμανικά	158, 159
Κλειδιά γερμανοπολύγωνα	159, 160
Κλειδιά γωνιακών τροχών	364
Κλειδιά κλειδαριών	406
Κλειδιά μπετού	101
Κλειδιά περιφράξεων	422
Κλειδιά πολύγωνα	158, 160
Κλειδιά σωληνωτά	164
Κλειδιά Τορξ	161
Κλειδοθήκες	414
Κλίπς για δίχτυα σκίασης	443
Κλίπς για τσέρκι	135
Κλίτσες	497
Κόλλα για πιστόλι θερμόκολλας	314
Κόλλες	260-265, 275-277, 282, 283
Κόλληση	371
Κολλητήρια γκαζιού	137
Κολλητήρια ηλεκτρικά	371
Κοντάρι ακούπας	447
Κοντάρια βαφής πτυσσόμενα	228
Κοντάρια πριονιών πτυσσόμενα	046
Κονταροπίνελα	225
Κονταροπρίονα	047-048, 050
Κοπίδια	098, 099
Κορδόνι ελαστικό	424
Κορδόνι μασκαρίσματος	359
Κόσες	022
Κόσκινα	490-491
Κόσκινο ελαιών	037
Κοσοσίδερα	023
Κουβάδες	116-118
Κουβάς χρώματος	235
Κουδούνια σκύλων - προβάτων	495-496
Κουρτίνες μπάνιου	477
Κουτιά αποθήκευσης	520
Κόφτες μοκετών	483-485
Κόφτες καλωδίων	370
Κόφτες πλακιδίων και εξαρτήματα	110-116
Κράνη εργατών	535
Κρικοπάλαγκα	422
Κροκοδειλάκια	370
Κύλινδροι	404-405, 409-410
Κυπριά	398, 407
Κώνιοι σημάνσεως	535
Λ	
Λαβές	416
Λαβές ρολών βαφής	234
Λαβές φραγκόφτυαρων	108
Λάδι αλυσίδας αλυσοπρίονου	312
Λάδι μίξης δίχρονου κινητήρα	312
Λαδικό	312
Λάμα αγκύρας	175
Λάμα συγκόλλησης	383
Λαμάκια συνδέσεων μαραγκών	375
Λαμάκια σύνδεσης στέγης	431, 432
Λάμες αέρος	175
Λάμες κρεοπωλών	174
Λάμες πριονιών	045-049
Λάμες σέγας	175
Λάμες τόξου	173

Προϊόν	Σελίδα
Λάμπες	367-368
Λάστικα ρόδας καρτσίων	119
Λάστικα πλυντηρίου	069
Λάστικα ποτίσματος	069
Λάστικα φουσκωτήρων	153
Λαστικάκια για καρφιά	218
Λάστικο οξυγόνου	069
Λάστικο πετρογκάζ	069
Λειαντικά εξαρτήματα	325-350, 354-356, 358
Λελέκι	019
Λεπίδι ξύστρας τζαμιών	241
Λεπίδια μοκετών	483-484, 486
Λιθοπόνιο	286
Λίμες	091-093
Λιμών τσαπιά	091
Λινάτσες	445
Λινέλαιο	286
Λοστοί	100
Λουκέτα	412-413
Λουκέτο μηχανών (φίδι)	413
Λουρίδες ζώων	498, 499
M	
Μαγνήτες ηλεκτροσυγκολλητών	144
Μακαράδες	423
Μανέλα	164
Μανταλάκια ξυλοουργών	171
Μάπα	211
Μάσα τζακιού	513
Μασάτια	480
Μάσκες ηλεκτροσυγκολλητών	148
Μάσκες προστασίας	548-551
Μάσκες κλοσκοπικών	024
Μάσκουλα	379
Ματσακόνι	094
Μαχαίρες	480
Μαχαίρια	481-483
Μέγγενες	170
Μεμβράνη stretch film	474
Μεμβράνη αποστράγγισης	442
Μεντεσέδες	378-379
Μεντεσέδες σιδηρόπορτας	383-385
Μεσινέζες	024-025
Μέτρα ρολό	125
Μέτρα σπαστά (πασέτα)	125-126
Μετροταινίες	126
Μηχανή σαγρέ	104
Μηχάνημα διαλογής ελαιοκαρ.	038
Μηχάνημα διαμόρφωσης προφίλ πλακιδίων	113
Μηχανισμός ταινιών	461, 469
Μικρόμετρα	124
Μίλια κρεβατιών	375
Μολυβδόφυλλο	130
Μολύβι μαρμαράδων	123
Μονωτικά ταράτσας	280
Μονωτικές ταινίες	457, 474
Μοτέρ αρνιού	501-502
Μοτέρ κοκορετσιού	503
Μοτέρ συρόμενης πόρτας	380
Μουστάς	480
Μούφες ντιζών	210
Μπαλάντζα συνεργείου	367

Προϊόν	Σελίδα
Μπαλαντζές	366
Μπατανόβουρτσες	227
Μπαταρίες	368-369
Μπίλια τρέιλερ	423
Μπιτόνια	488-489
Μπλουζάκια εργασίας	532
Μπουζόκλειδα	162
Μπουζοσαστρίφωνα	201
Μπουλονκόφτες	127
Μυλαράκια ντουλαπιών	215
Μύλος υποδημάτων	486
Μυσταριά	101-104
Μύτες καταβιδιών	165-168
Ν	
Νάυλον βαψίματος	446, 461
Ναυτικά κλειδιά	419-420
Νέφτι	294
Νήμα αλιείας	427
Νήμα στάθμης	124
Νιτσεράδες	533
Ντίζες	189
Ντίζες κεραιών	214-215
Ξ	
Ξύλα	063, 065-066, 447
Ξύστρα για ρετσίνα	006
Ξύστρες	239-241
Ξυστρί αλόγων - ψαριών	493
Ο	
Οδηγός δαπέδου	379
Οδηγός κίνησης συρόμενης πόρτας	380
Οδηγός συρόμενης πόρτας	379
Ορεικαλκοκόλληση	152
Ούπα	206-209
Π	
Παγίδες ποντικών	500
Παλάγκα αλυσίδας	422
Παλάγκα κρίκου	422
Παξιμάδια	209-210
Παξιμάδια τροχού	364
Παραφινέλαιο	286
Παρεμβύσματα	109-110
Παρετίνα	284
Πασαλάκια ζώων	500
Πάσσαλοι αρνιών	506
Πάστα καθαρισμού σιλικόνης	268, 311
Πάστα καθαρισμού χεριών	311
Πατιπά	016-017
Πατρόγκες	226
Παχύμετρα	124
Πείρος ασφαλείας	412
Πέλμα για πίκεις	122
Πέλματα	391-393
Πένσα αποστατών πλακιδίων	108
Πεντάφθαλμο	227
Πέργκολας εξαρτήματα	429-435
Περόνες αρότρου	206
Πεταλούδες	211
Πεταλούδες για τριβίδια	106
Πετονιές	428
Πετσετάκια καθαρισμού	357
Πετρελίερα	154

Προϊόν	Σελίδα
Πετρογκάζ	138
Πετρογκάζ εξαρτήματα	139
Πηρούνες	027-028
Πίκεις	123
Πι φουρουσιών	431
Πι Ψαλιδιών	431
Πινέζες	221
Πινέλα	222-225
Πιπίλες κουνελίων	492
Πίσσες	293
Πιστόλι αρμολόγησης	238
Πιστόλι δεματικών	373
Πιστόλια αέρος	154
Πιστόλια αφρού πολυουρεθάνης	251
Πιστόλια βαφής	229
Πιστόλια θερμάκollας	314
Πιστόλια νερού	076-077
Πιστόλια σιλικόνης	237-238
Πλακέτα μεταλλική	200
Πλάνες	171
Πλέγματα	440
Πόδια ντουλαπιών	375
Ποδιές ηλεκτροσυγκολλητών	147-148
Ποδιές μαρμαράδων-κλιοσκοπών	157
Ποδιές οικοδομής	157
Πολύγωνα κλειδιά	158, 160
Πολυεστέρας	294
Πολύκλειδο	128
Πολύριζα	365
Πολύσπαστο	164
Πόμολλα	393-395, 415-416
Πόντα	171
Ποντικόκαλλες	500
Ποτάσα	286
Ποτηροτρίπανα	176-178
Ποτιστήρια	488
Ποτιστικά	072-075
Ποτίστρες	492
Πούδρα ξηράς τριβής (φούμο)	359
Πριόνι γυψοσανίδας	173
Πριόνι κρεπωλών	174
Πριόνια κλάδου	045-050
Πριόνια μελαμίνης	172-173
Πριόνια τόξου	173
Πριτσίνια	221
Προβατοπάλιδα	493
Προβολέας με τρίποδο	146
Προγραμματιστές νερού	078
Προεκτάσεις βούρτσας καμινάδας	515
Προεκτάσεις καλώδιο	365-366
Προεκτάσεις τουμπόβουρτσας	315
Προέκταση βρύσης εύκαμπτη	131
Προέκταση κασάνιας	164
Πρόκα σίτας	218
Προκοβγάλτες	100-101
Πυράφια	133
Πυροσιές	506
Πυρόκωμα	284
Ρ	
Ραβδιά μηχανής	036
Ραβδιστήρια	036

Προϊόν	Σελίδα
Ράγες	380
Ρακόρ βρύσης	070-072, 133
Ράματα	427
Ράουλα	381-383
Ράσπα για Velcro	172
Ράσπες	091-092
Ράφια γαλβανιζέ και εξαρτ.	530-531
Ράφια ντέξιον και εξαρτήματα	529-530
Ράφια σούπερ μάρκετ και εξαρτ.	526-528
Ροδέλα τρυπανόβιδας	199
Ροδέλες	212-214
Ρόδες	119-120, 385-387
Ρόδες καρτσίων	119
Ροζάντζα	418
Ροζέτα ασφαλείας	404
Ροζέτες σωλήνων σόμπας	515
Ρόκα	372
Ρολά βαφής	230-233
Ρουξούνια ποτιστηριών	488
Ρυθμιστές πετρογκάζ	137
Ρυμούλκα με γάντζους	423
Σ	
Σάκοι	036
Σακοράφες	428
Σεγάτσες	172
Σέλες λάστιχων	067-068
Σέσουλες	491
Σετ προστασίας προσώπου	535
Σετ τζακιού	517
Σιλικόνες	251-253, 268-271
Σίτες	439
Σίτες αλεύρων	491
Σίτες τζακιού	517-519
Σκάλες	451-456
Σκαλιστήρια	009-013
Σκαλοσκαμπό	456
Σκαφάκια χρωμάτων	234-235
Σκάφες	116-117
Σκελέτα	173-174
Σκέπαστρα	445
Σκερπάνια	097
Σκερπανοστενές	005-006
Σκληρυντής πολυεστέρα	294
Σκόνες	285-286
Σκούπες	448-450
Σκούπες φύλλων	032-033
Σκούπες χόρτου	447
Σμάλτο επιδιόρθωσης	311
Σολντερίνη	371
Σούβλες	504-505
Σουβλί	169
Σουγιόδες	038-039, 483
Σούστες κλειδιών	414
Σούστες πόρτας - μπράτσου	377
Σπάγγι	426
Σπάθες	021
Σπανιολέτες	395-396
Σπάτουλες	241-247
Σπιράλ ντους	130
Σπιράλ υδραυλικών	129
Σπρέι	295, 302-310

Προϊόν	Σελίδα
Στεγάκι παραθύρων	433
Στεγνωτήρια ρούχων	515
Στεγνωτικό για λινέλαιο	286
Στειλιάρια Fiberglass	064
Στήριγμα κουπαστής	433
Στήριγμα σωλήνων ντουλάπας	376
Στήριγμα φουρουσιών	433
Στηρίγματα σωλήνων	134
Στηρίγματα υδρορουνών	134, 135
Στήριμα ράγας οροφής	380
Στίλσον	129
Στοκαδόροι	241
Στοκαδόρος με λάστιχο	106
Στόκοι	256-259, 278-279
Στόπερ ρολών	374
Στραβόκαρφα	206
Στραβοπίνελα	225-226
Στριφάρια	501
Στριφτήρι συρμάτων	428
Στριφώνια	200-203
Στυλό πλακιδίων	116
Στυλώματα παραθύρων	215
Σύνδεσμοι λάστιχων ποτ.	070-072
Συνδετικά	421
Συντηρητικά ξύλου	290
Σύρμα για σασκούλες μπαζών	428
Σύρμα λουλουδιών	040
Σύρμα μηχανής αργκόν	152
Σύρματα	439-441
Συρματόβουρτσες	315-316
Συρματόσχοινα	419
Συρτάρια συρταροθήκης	521
Συρταροθήκες	520, 522-523
Σύρτες	388-390
Συστολικά σωλήνων σόμπας	515
Σφήνες	043
Σφήνες θυρών	477
Σφήνες σφυριών	096
Σφιγκτήρες αρνιών	505
Σφιγκτήρες μαραγκών	171
Σφιγκτήρες συρματοσχοίων	419
Σφιγκτήρες σωλήνων	079-081
Σφουγγαράκια λείανσης	358
Σφουγγάρια	106-107
Σφραγιστικά	254-256, 259-260, 271-275
Σφυρί κόσας	022
Σφυριά	095-096
Σφυριά ηλεκτροσυγκολλητών	144
Σκαράκια εξασεριμού	375
Σκαράκια σιφονιού	131
Σκάρες τζακιού	516
Σκάρες ψησίματος	506, 509-512
Σκοινιά	425-426
Σωλήνας δενδροκομίας	041
Σωλήνες γαλβανιζέ	514
Σωλήνες εμαγιέ	514
Σωληνοσυνδέσεις	436-438
Σωληνωτά κλειδιά	164
Σώματα γείωσης πλ/κολλητών	145-146, 148

T

Ταινίες	466-474, 476
---------	--------------

Προϊόν	Σελίδα
Ταινίες Tesa	457-464
Ταίστρες	492-493
Τανάλιες	127-128
Τάπα σωλήνων σόμπας	515
Τάπες βίδας	214
Τάπες κοιλοδοκού	431
Ταφ γαλβανιζέ	514
Ταφ εμαγιέ	514
Ταφ πέργκολας	432
Ταχυσύνδεσμοι ποτίσματος	070-072
Τελάρια	219-220
Τεφλόν	475
Τηλέφωνο ντους	130
Τορξ κλειδιά	161
Τουμπόβουρτσες	315
Τράκες ακύλων – προβάτων	494
Τριβίδια	104-106, 359
Τρικέλια	027
Τρίποδο σουβλας	506
Τρόμπες λαδιού	489
Τροχοί κοπής – λείανσης	317-321
Τροχόκλειδα	364
Τροχός μέτρησης αποστάσεων	126
Τρυπάνια SDS PLUS	181
Τρυπάνια γενικής χρήσης	180
Τρυπάνια μετάλλων	181-183
Τρυπάνια μετετού	179-180
Τρυπάνια ξύλου – φτερού	181, 184
Τσαντές οικοδομής	156
Τσαπιά λιμών	091
Τσαπραζολόγοι	038
Τσεκμέδες	039
Τσεκούρια	041-043
Τσεκουρακασμαδάκι	044
Τσεκουροστενές	044
Τσέρκια	135
Τσιγγέλια	503
Τσιμέντα	285
Τσιμπίδα ξύλου	513
Τσιμπίδες ηλεκτρ/κολλητών	145, 148
Τσιμπίδες κάρβουνων	505
Τσιμπίδες υδραυλικών	129
Τσουγκράνες μεταλλικές	028-030
Τσουγκράνες πλαστικές	034
Τσοκάκια	475

Υ

Υαλοβάμβακας	294
Υαλοκαθαριστήρες	108-109
Υγρό διαμόρφωσης σιλικόνης	310
Υδρονέτα & ανταλλακτικά	090
Υδρορυθμιστές	075
Υποδήματα	552-564
Υποδοχές ποτηροτρίπανων	177
Υφασμα εδαφοκάλυψης	441

Φ

Φάκες	500
Φακοί	369
Φακός σινιάλο κινδύνου	367
Φαλτσέτες	040
Φαλτσωνιές	124
Φαλτσοκούτια	174

Προϊόν	Σελίδα
Φαράσι στενό στόφας	513
Φαράσια	448
Φάρος ηλεκτρονικός συρόμενης πόρτας	380
Φίλτρα μασκών προστασίας	548
Φίλτρο νερού για βρύση	131
Φις σούκο	365
Φλατζκόλλες	253, 271
Φλόγιστρα	136
Φοριαμοί	524-525
Φόρμες εργασίας	532
Φουρκέτα	376
Φουσκοκλίτες και ανταλ.	153-154
Φραγκόφτυαρα και λαβές	108
Φρέζα ξύλου	184
Φρουτοσυλλέκτης	035
Φτυαράκια τζακιού	513
Φτυάρια	014-018
Φύλλο πολυαιθυλενίου	041
Φυλλοσυλλέκτης πλαστικός	131
Φυσερά ψεκασμού	090
Φυτευτήρια	030
Φωλιά τρέιλερ	424
Φωλιές κουνελιών	492

X

Χαλκάδες	203-204, 421
Χαντζάρι	021
Χαρτί duplex	446
Χαρτί οντουλέ	446
Χαρτοταινίες	462-463, 466, 472, 473
Χειρόβουρτσα	227
Χερούλια φεγγιτών	417
Χημικό βύσμα και εξαρτ.	265, 275
Χούφτα SDS PLUS	179
Χούφτες	412
Χρώματα	288, 291-292
Χρωματολόγιο Σπρέι	296-301
Χταπόδια	424
Χωνιά	487, 488

Ψ

Ψαλίδα κλάδου αέρος	051
Ψαλίδες κλάδου με κοντάρι	057
Ψαλίδες κλάδου χειρός	051-056
Ψαλίδες κορμού	057-059
Ψαλίδες κορυφής	056-057
Ψαλίδες τρύγου	054-056
Ψαλίδες χαρακάματος	040
Ψαλίδες κλάδων-γκαζόν	060
Ψαλίδια γενικής χρήσης	486
Ψαλίδια λαμαρίνας	486
Ψαλίδων ανταλλακτικά	061-062
Ψεκαστήρες	081-084
Ψεκαστήρων ανταλλακτικά	085-089
Ψησταριές	507-508

Ω

Ωμέγα ψαλιδιών	431
Ωτοασπίδες	535

Αναπτύσσουμε συνεχώς
την **ποικιλία των
προϊόντων μας!**

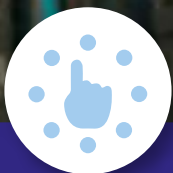

Ποικιλία προϊόντων

Όλες οι κατηγορίες των προϊόντων που παρέχουμε περιλαμβάνουν ποιοτικά εργαλεία σε ανταγωνιστικές τιμές και διαφορετικές επιλογές για να βρίσκετε πάντα την καλύτερη λύση για τους πελάτες σας.



Εγγυημένη ποιότητα

Η συνεργασία μας με έμπιστους και κορυφαίους στο είδος τους προμηθευτές, συντελούν στην προσφορά προϊόντων υψηλών προδιαγραφών και άριστης κατασκευής.





11259
11260

PATCO

ΣΦΥΡΛΑΤΗ

ΑΞΙΝΑ ΣΤΡΟΓΓΥΛΗ

ΚΩΔΙΚΟΣ ΞΥΛΟΥ
03080 στο Νο 1
01623 στο Νο 2

GET IT NOW

Barcode	Description	Quantity
11259	Code No 1 - 195 mm (A) - 1000 gr	10
11260	Code No 2 - 205 mm (A) - 1200 gr	10



10016
03528

Martin's Craft

ΑΞΙΝΑ ΣΤΡΟΓΓΥΛΗ

ΚΩΔΙΚΟΣ ΞΥΛΟΥ
01623 στο 22530
03080 στο 22525

HOT SELLER

Barcode	Description	Quantity
10016	Code No 2 / 22530 - 195 mm (A) - 900 gr	12
03528	Code No 2.5 / 22525 - 230 mm (A) - 1100 gr	12



03060
03146

BELLOTA

ΑΞΙΝΑ ΣΤΡΟΓΓΥΛΗ 338

ΚΩΔΙΚΟΣ ΞΥΛΟΥ
01623 στο 338-0
03080 στο 338-A

Barcode	Description	Quantity
03060	Code 338-0 - 200 mm (A) - 1000 gr	12
03146	Code 338-A - 215 mm (A) - 1150 gr	12



00160
00161

CHILLINGTON CROCODILE

ΑΞΙΝΑ ΣΤΡΟΓΓΥΛΗ 3489

ΚΩΔΙΚΟΣ ΞΥΛΟΥ
01623

Barcode	Description	Quantity
00160	Code No 2 - 215 mm (A) - 1000 gr	12
00161	Code No 2.5 - 230 mm (A) - 1350 gr	12





ΑΞΙΝΑ ΝΑΠΟΛΕΟΝΤΟΣ

ΚΩΔΙΚΟΣ ΞΥΛΟΥ
01623

Barcode	Description	Quantity
08724	μεγάλη - 120 mm (A) - 600 gr	5





ΑΞΙΝΑ ΤΥΠΟΥ ΚΑΜΠΑΝΑ

ΚΩΔΙΚΟΣ ΞΥΛΟΥ
03835

Barcode	Description	Quantity
08673	125 mm (A) - 300 gr	5



GET IT NOW



ΑΞΙΝΑ ΒΑΜΒΑΚΟΣ ΣΤΡΟΓΓΥΛΗ

**ΚΩΔΙΚΟΣ
ΞΥΛΟΥ
03835**

11296 150 mm (A) - 800 gr 10



**ΑΞΙΝΑ
ΠΑΤΑΤΟΚΑΛΛΙΕΡΓΕΙΑΣ ΣΤΡΟΓΓΥΛΗ**

**ΚΩΔΙΚΟΣ
ΞΥΛΟΥ
05314**

08357 Code 72-A - 225 mm (A) - 700 gr 6



**ΑΞΙΝΑ
ΠΑΤΑΤΟΚΑΛΛΙΕΡΓΕΙΑΣ ΣΤΡΟΓΓΥΛΗ**

**ΚΩΔΙΚΟΣ
ΞΥΛΟΥ
01623**

00012 Code No 2.5 - 220 mm (A) - 1030 gr 10



ΑΞΙΝΑ ΒΑΜΒΑΚΟΣ ΣΤΡΟΓΓΥΛΗ Β'

**ΚΩΔΙΚΟΣ
ΞΥΛΟΥ
01623**

08743 155 mm (A) - 500 gr 5



ΑΞΙΝΑ ΚΟΡΙΝΘΙΑΣ ΣΤΡΟΓΓΥΛΗ

**ΚΩΔΙΚΟΣ
ΞΥΛΟΥ
01623**

01832 180 mm (A) - 900 gr 5





GET IT NOW

ΑΞΙΝΑ ΠΑΤΑΤΟΚΑΛΛΙΕΡΓΕΙΑΣ ΤΕΤΡΑΓΩΝΗ 01623

11267	Code No 2.5 - 205x145 mm (AxB) - 1400 gr	10





ΚΩΔΙΚΟΣ ΞΥΛΟΥ 01623

ΑΞΙΝΑ ΠΑΤΑΤΟΚΑΛΛΙΕΡΓΕΙΑΣ ΤΕΤΡΑΓΩΝΗ 01623

10550	Code No 2 /22534 - 200x150 mm (AxB) - 920 gr	12





ΚΩΔΙΚΟΣ ΞΥΛΟΥ 01623

ΑΞΙΝΑ ΠΑΤΑΤΟΚΑΛΛΙΕΡΓΕΙΑΣ ΤΕΤΡΑΓΩΝΗ 01623

00164	Code No 2.5-6073C - 205x150 mm (AxB) - 950 gr	12





ΚΩΔΙΚΟΣ ΞΥΛΟΥ 01623

ΑΞΙΝΑ PIRANHA

11273	205x130 mm (AxB) - 1200 gr	10





GET IT NOW

ΚΩΔΙΚΟΣ ΞΥΛΟΥ 01623

ΑΞΙΝΑ ΠΑΤΑΤΟΚΑΛΛΙΕΡΓΕΙΑΣ ΤΕΤΡΑΓΩΝΗ 01623

00028	Code No 3 - 200x150 mm (AxB) - 1070 gr	6







11268

11269

11270

ΚΩΔΙΚΟΣ ΞΥΛΟΥ 01623 στο Νο 2 03080 στο Νο 2.5 & Νο 3

ΑΞΙΝΑ ΤΕΤΡΑΓΩΝΗ

11268	Code No 2 - 145x145 mm (AxB) - 870 gr	10
11269	Code No 2.5 - 200x175 mm (AxB) - 1350 gr	10
11270	Code No 3 - 225x200 mm (AxB) - 1550 gr	12

GET IT NOW



BELLOTA



ΑΞΙΝΑ ΤΕΤΡΑΓΩΝΗ 337-A

ΚΩΔΙΚΟΣ ΞΥΛΟΥ 01623

		
03748	215x190 mm (AxB) - 1200 gr	12

Martin^{craft}



ΑΞΙΝΑ ΤΕΤΡΑΓΩΝΗ 22520

ΚΩΔΙΚΟΣ ΞΥΛΟΥ 01623

		
03527	205x170 mm (AxB) - 1030 gr	12

 00162
 00163
CHILLINGTON CROCODILE



ΑΞΙΝΑ ΤΕΤΡΑΓΩΝΗ 3490

ΚΩΔΙΚΟΣ ΞΥΛΟΥ 01623

		
00162	Code No 2 - 200x180 mm (AxB) - 1030 gr	12
00163	Code No 2.5 - 210x190 mm (AxB) - 1250 gr	12

Martin^{craft}



ΑΞΙΝΑ ΚΡΗΤΗΣ 22528

ΚΩΔΙΚΟΣ ΞΥΛΟΥ 01623

		
10017	185x115 mm (AxB) - 920 gr	12

 11262
 11263
PATCO



ΑΞΙΝΑ ΚΡΗΤΗΣ

ΚΩΔΙΚΟΣ ΞΥΛΟΥ 03080

		
11262	Code No 1 - 190x105 mm (AxB) - 1020 gr	10
11263	Code No 2 - 210x115 mm (AxB) - 1120 gr	10

BELLOTA



ΑΞΙΝΑ ΚΡΗΤΗΣ 53-A

ΚΩΔΙΚΟΣ ΞΥΛΟΥ 01623

		
13252	225x75 mm (AxB) - 1000 gr	12



BELLOTA

ΑΞΙΝΑ ΚΡΗΤΗΣ 340-A

ΚΩΔΙΚΟΣ ΞΥΛΟΥ 01623

03836 183x110 mm (AxB) - 850 gr 12



BELLOTA

ΑΞΙΝΑ ΚΕΦΑΛΛΗΝΙΑΣ 150-A

ΚΩΔΙΚΟΣ ΞΥΛΟΥ 01623

01119 270 mm (A) - 935 gr 12



PATCO

ΑΞΙΝΑ ΚΕΦΑΛΛΗΝΙΑΣ ΤΡΙΓΩΝΗ

ΚΩΔΙΚΟΣ ΞΥΛΟΥ 01623

11265 260 mm (A) - 1000 gr 10

GET IT NOW



BELLOTA

ΑΞΙΝΑ ΚΕΦΑΛΛΗΝΙΑΣ 328-B

ΚΩΔΙΚΟΣ ΞΥΛΟΥ 01623

00017 210 mm (A) - 900 gr 12



PATCO

ΑΞΙΝΑ ΚΕΦΑΛΛΗΝΙΑΣ ΚΑΡΔΙΑ

ΚΩΔΙΚΟΣ ΞΥΛΟΥ 01623

11264 195 mm (A) - 940 gr 10

GET IT NOW



PATCO

ΣΚΕΡΠΑΝΟΣΤΕΝΗ

ΚΩΔΙΚΟΣ ΞΥΛΟΥ 01623

11271 200x90 mm (AxB) - 1200 gr 10

GET IT NOW





ΣΚΕΡΠΑΝΟΣΤΕΝΗ 22532
 ΚΩΔΙΚΟΣ ΞΥΛΟΥ 01623
 10018  220x85 mm (AxB) - 1000 gr  6

 **BELLOTA**

ΑΞΙΝΑ ΣΤΕΝΗ 11-A
 ΚΩΔΙΚΟΣ ΞΥΛΟΥ 05315
 04201  240x120 mm (AxB) - 1850 gr  12

 **BELLOTA**

ΑΞΙΝΑ ΣΤΕΝΗ 5
 ΚΩΔΙΚΟΣ ΞΥΛΟΥ 05315
 04200  230x120 mm (AxB) - 1550 gr  12



ΞΥΣΤΡΑ ΓΙΑ ΡΕΤΣΙΝΙ
 ΚΩΔΙΚΟΣ ΞΥΛΟΥ 04160
 06616  120x60 mm (AxB) - 650 gr  6

 **BELLOTA**

ΑΞΙΝΑ ΛΑΣΠΗΣ 252-A
 ΚΩΔΙΚΟΣ ΞΥΛΟΥ 05315
 04183  165x190 mm (AxB) - 700 gr  12

 **BELLOTA**

ΑΞΙΝΑ ΛΑΣΠΗΣ 95-A
 ΚΩΔΙΚΟΣ ΞΥΛΟΥ 05315
 07482  170x135 mm (AxB) - 650 gr  12





GET IT NOW

ΑΞΙΝΑ ΛΑΣΠΗΣ

ΚΩΔΙΚΟΣ ΞΥΛΟΥ 03080

		
11266	160x150 mm (AxB) - 980 gr	10





HOT SELLER

ΑΞΙΝΑ ΛΑΣΠΗΣ 22510

ΚΩΔΙΚΟΣ ΞΥΛΟΥ 01623

		
03526	180x155 mm (AxB) - 880 gr	12





ΑΞΙΝΑ ΛΑΣΠΗΣ Β'

ΚΩΔΙΚΟΣ ΞΥΛΟΥ 03080

		
00004	160x140 mm (AxB) - 570 gr	10





ΑΞΙΝΑ ΛΑΣΠΗΣ 349-1

ΚΩΔΙΚΟΣ ΞΥΛΟΥ 01623

		
02614	150x150 mm (AxB) - 670 gr	12





ΑΞΙΝΑ ΚΗΠΟΥ 3082

ΚΩΔΙΚΟΣ ΞΥΛΟΥ 00934

		
09208	144x120 mm (AxB) - 260 gr	6





ΑΞΙΝΑ ΚΗΠΟΥ ΠΑΛΙΝΔΡΟΜΙΚΗ 3083

ΚΩΔΙΚΟΣ ΞΥΛΟΥ 00934

		
09209	100x150 mm (AxB) - 215 gr	6





ΑΞΙΝΕΣ - ΑΞΙΝΟΚΑΣΜΑΔΕΣ



BELLOTA

ΓΡΑΒΑΛΟ ΚΗΠΟΥ 3081
 ΚΩΔΙΚΟΣ ΞΥΛΟΥ 00934
 04191 107x153 mm (AxB) - 325 gr 6

BELLOTA

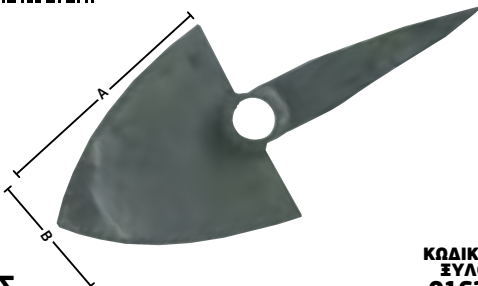
ΑΝΑΜΟΧΛΕΥΤΗΣ ΚΗΠΟΥ 3080
 ΚΩΔΙΚΟΣ ΞΥΛΟΥ 00934
 09207 125x500 mm (AxB) - 1760 gr 1

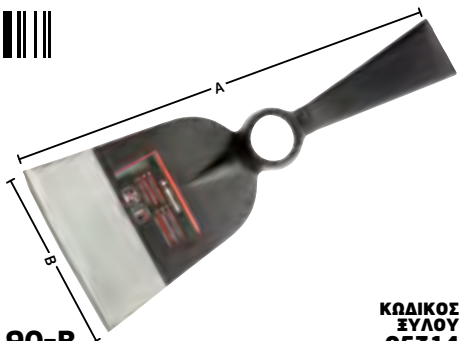

ΑΞΙΝΑ ΠΑΡΝΑΣΙΔΟΣ
 ΚΩΔΙΚΟΣ ΞΥΛΟΥ 01623
 00029 360x200 mm (AxB) - 1150 gr 5

BELLOTA

ΑΞΙΝΟΚΑΣΜΑΣ 90-B
 ΚΩΔΙΚΟΣ ΞΥΛΟΥ 05314
 00349 320x125 mm (AxB) - 875 gr 12



ΚΑΣΜΑΣ ΑΓΡΟΚΑΛΛΙΕΡΓΙΑΣ ΔΙΚΟΠΟΣ
 ΚΩΔΙΚΟΣ ΞΥΛΟΥ 01623
 11293 320x83 mm (AxB) - 1000 gr 10



ΚΑΣΜΑΣ ΑΓΡΟΚΑΛΛΙΕΡΓΙΑΣ ΜΕ ΜΥΘΗ
 ΚΩΔΙΚΟΣ ΞΥΛΟΥ 01623
 11294 320x83 mm (AxB) - 840 gr 10



ΚΑΣΜΑΣ PA91G ΜΕ ΛΑΒΗ FIBERGLASS 900 mm
 ΚΩΔΙΚΟΣ ΞΥΛΟΥ 04353
 04958 460x55 mm (AxB) - 2550 gr 4

■ NEW ARRIVAL ΝΕΑ ΑΦΙΞΗ ■ HOT SELLER ΚΑΛΥΤΕΡΟ ΣΤΗΝ ΠΩΛΗΣΗ ■ GET IT NOW ΑΞΙΖΕΙ ΝΑ ΑΓΟΡΑΣΕΙΣ ΤΩΡΑ



BELLOTA

ΚΑΣΜΑΔΑΚΙ ΜΙΚΡΟ 5933-0N ΜΕ ΞΥΛΟ 300 mm

ΚΩΔΙΚΟΣ ΞΥΛΟΥ 00934

03135	270x39 mm (AxB) - 450 gr	6
-------	--------------------------	---

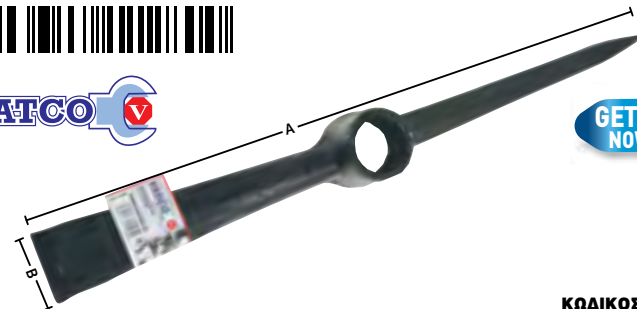

ΠΑΤΣΟ

ΚΑΣΜΑΣ ΟΔΟΠΟΙΪΑΣ

ΚΩΔΙΚΟΣ ΞΥΛΟΥ 03079

GET IT NOW

11280	500x50 mm (AxB) - 2030 gr	12
-------	---------------------------	----



BELLOTA

ΚΑΣΜΑΣ ΟΔΟΠΟΙΪΑΣ 5001-A

ΚΩΔΙΚΟΣ ΞΥΛΟΥ 03079

03066	450x45 mm (AxB) - 2050 gr	6
-------	---------------------------	---



Martin's craft

ΚΑΣΜΑΣ ΟΔΟΠΟΙΪΑΣ 22210

ΚΩΔΙΚΟΣ ΞΥΛΟΥ 03079

HOT SELLER

03509	520x50 mm (AxB) - 2000 gr	6
-------	---------------------------	---



BELLOTA

ΣΚΑΛΙΣΤΗΡΙ 7-A

ΚΩΔΙΚΟΣ ΞΥΛΟΥ 03835

09200	135x50 mm (AxB) - 325 gr	12
-------	--------------------------	----



BELLOTA

ΣΚΑΛΙΣΤΗΡΙ 1

ΚΩΔΙΚΟΣ ΞΥΛΟΥ 03835 στο 1-A & 1-B
01623 στο 1-C

04180	Code 1-A - 130x80 mm (AxB) - 375 gr	12
04181	Code 1-B - 150x90 mm (AxB) - 450 gr	12
04182	Code 1-C - 160x105 mm (AxB) - 700 gr	12



BELLOTA

ΣΚΑΛΙΣΤΗΡΙ 232-A

ΚΩΔΙΚΟΣ ΞΥΛΟΥ 03835

09201	110x70 mm (AxB) - 300 gr	12
-------	--------------------------	----



ΣΚΑΛΙΣΤΗΡΙΑ

BELLOTA



ΣΚΑΛΙΣΤΗΡΙ 182

ΚΩΔΙΚΟΣ ΞΥΛΟΥ 03835

  
04804 150x50 mm (AxB) - 400 gr 12

BELLOTA



ΣΚΑΛΙΣΤΗΡΙ ΜΕ ΜΥΘΗ 230-A

ΚΩΔΙΚΟΣ ΞΥΛΟΥ 03835

  
04648 260x70 mm (AxB) - 475 gr 12

BELLOTA



ΣΚΑΛΙΣΤΗΡΙ ΔΙΧΑΛΟ-ΜΥΘΗ ΗΟΕ229ΑΡ

ΚΩΔΙΚΟΣ ΞΥΛΟΥ 03835

  
01482 302 mm (A) - 525 gr 12

BELLOTA



ΣΚΑΛΙΣΤΗΡΙ ΔΙΧΑΛΟ 228-A

ΚΩΔΙΚΟΣ ΞΥΛΟΥ 03835

  
05408 270x70 mm (AxB) - 450 gr 12



BELLOTA



ΣΚΑΛΙΣΤΗΡΙ ΔΙΧΑΛΟ 344

ΚΩΔΙΚΟΣ ΞΥΛΟΥ 03835



  
03882 305x80 mm (AxB) - 660 gr 12

PATCO 



ΣΚΑΛΙΣΤΗΡΙ ΔΙΧΑΛΟ

ΚΩΔΙΚΟΣ ΞΥΛΟΥ 04160

  
11276 255x70 mm (AxB) - 400 gr 15

GET IT NOW

■ NEW ARRIVAL ΝΕΑ ΑΦΙΞΗ ■ HOT SELLER ΚΑΛΥΤΕΡΟ ΣΤΗΝ ΠΩΛΗΣΗ ■ GET IT NOW ΑΞΙΖΕΙ ΝΑ ΑΓΟΡΑΣΕΙΣ ΤΩΡΑ

ΣΚΑΛΙΣΤΗΡΙΑ



Martin craft

HOT SELLER

ΣΚΑΛΙΣΤΗΡΗ ΔΙΧΑΛΟ 22230

ΚΩΔΙΚΟΣ ΞΥΛΟΥ 00939

03532 255x65 mm (AxB) - 500 gr 6



PATCO

GET IT NOW

ΣΚΑΛΙΣΤΗΡΗ ΔΙΚΟΠΟ

ΚΩΔΙΚΟΣ ΞΥΛΟΥ 03835

11290 250x40 mm (AxB) - 400 gr 12



PATCO

GET IT NOW

ΣΚΑΛΙΣΤΗΡΗ ΜΕ ΜΥΤΗ

ΚΩΔΙΚΟΣ ΞΥΛΟΥ 03835

11289 250x40 mm (AxB) - 400 gr 12



PATCO

GET IT NOW

ΣΚΑΛΙΣΤΗΡΗ ΜΕΓΑΛΟ

ΚΩΔΙΚΟΣ ΞΥΛΟΥ 01623

11261 160x90 mm (AxB) - 900 gr 10



INTER

GET IT NOW

ΣΚΑΛΙΣΤΗΡΗ ΜΕΓΑΛΟ

ΚΩΔΙΚΟΣ ΞΥΛΟΥ 01623

05131 165x95 mm (AxB) - 900 gr 6



PATCO

GET IT NOW

ΣΚΑΛΙΣΤΗΡΗ ΜΕΣΑΙΟ

ΚΩΔΙΚΟΣ ΞΥΛΟΥ 01623

11292 160x100 mm (AxB) - 700 gr 12



ΣΚΑΛΙΣΤΗΡΙΑ

INTER



ΣΚΑΛΙΣΤΗΡΙ ΜΕΣΑΙΟ

ΚΩΔΙΚΟΣ ΞΥΛΟΥ 01623

  
05132 150x103 mm (AxB) - 660 gr 6

PATCO



ΣΚΑΛΙΣΤΗΡΙ ΜΙΚΡΟ

ΚΩΔΙΚΟΣ ΞΥΛΟΥ 03835

  
11291 110x70 mm (AxB) - 300 gr 12

INTER



ΣΚΑΛΙΣΤΗΡΙ ΜΙΚΡΟ

ΚΩΔΙΚΟΣ ΞΥΛΟΥ 03835

  
05133 130x73 mm (AxB) - 450 gr 6





ΣΚΑΛΙΣΤΗΡΙ ΔΙΧΑΛΟ - ΣΤΡΟΓΓΥΛΟ

ΚΩΔΙΚΟΣ ΞΥΛΟΥ 03835

  
02369 250 mm (A) - 400 gr 5





ΣΚΑΛΙΣΤΗΡΙ ΔΙΧΑΛΟ Β'

ΚΩΔΙΚΟΣ ΞΥΛΟΥ 03835

  
08723 260x75 mm (AxB) - 300 gr 5





ΣΚΑΛΙΣΤΗΡΙ ΣΤΡΟΓΓΥΛΟ

ΚΩΔΙΚΟΣ ΞΥΛΟΥ 03835

  
08748 110 mm (A) - 250 gr 5

■ NEW ARRIVAL ΝΕΑ ΑΦΙΞΗ ■ HOT SELLER ΚΑΛΥΤΕΡΟ ΣΤΗΝ ΠΩΛΗΣΗ ■ GET IT NOW ΑΞΙΖΕΙ ΝΑ ΑΓΟΡΑΣΕΙΣ ΤΩΡΑ





ΣΚΑΛΙΣΤΗΡΙ ΤΕΥΤΛΩΝ ΜΙΚΡΟ

ΚΩΔΙΚΟΣ ΞΥΛΟΥ
06113 ή 01909

08722	230x200 mm (AxB) - 450 gr	5





ΣΚΑΛΙΣΤΗΡΙ ΔΙΧΑΛΟ ΜΕ ΜΕΤΑΛΛΙΚΗ ΛΑΒΗ

01408	345x160 mm (ΓxA) - 300 gr	5







04189
01857
04188

ΣΚΑΛΙΣΤΗΡΙ ΜΕ ΣΩΛΗΝΑ 1m

04189	δίκοπο - 260x65 mm (AxB)	5
01857	δίχαλο - 260x70 mm (AxB)	5
04188	με μύτη - 260x65 mm (AxB)	5





ΣΚΑΛΙΣΤΗΡΑΚΙ FIBERGLASS 2990

09214	332x203 mm (ΓxA) - 153 gr	6





ΣΚΑΛΙΣΤΗΡΙ ΜΕ ΜΥΤΗ ΜΕ ΞΥΛΙΝΗ ΛΑΒΗ

06219	230x70 mm (AxB)	5





ΣΚΑΛΙΣΤΗΡΑΚΙ ΑΛΟΥΜΙΝΙΟΥ 3005

06809	310x202 mm (ΓxA) - 354 gr	6





ΣΚΑΛΙΣΤΗΡΙ ΔΙΧΑΛΟ ΜΕ ΞΥΛΙΝΗ ΛΑΒΗ

06220	230x80 mm (AxB)	5



ΦΤΥΑΡΙΑ



BELLOTA

ΦΤΥΑΡΙ ΣΤΡΟΓΓΥΛΟ 5556-2 SM

ΚΩΔΙΚΟΣ ΞΥΛΟΥ 00931

03085	270x255 mm (AxB) - 910 gr	25
-------	---------------------------	----



BELLOTA

ΦΤΥΑΡΙ ΚΥΡΤΟ 5552-26 SM

ΚΩΔΙΚΟΣ ΞΥΛΟΥ 00139

GET IT NOW

03084	270x255 mm (AxB) - 850 gr	25
-------	---------------------------	----

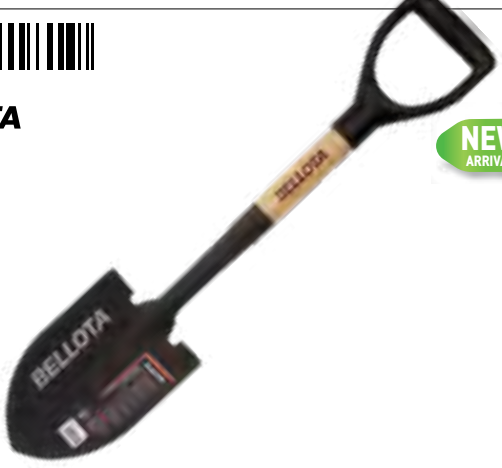

BELLOTA

ΦΤΥΑΡΙ ΜΙΚΡΟ ΠΟΛΛΑΠΛΩΝ ΧΡΗΣΕΩΝ BELLOTA 5526

ΚΩΔΙΚΟΣ ΞΥΛΟΥ 00931

NEW ARRIVAL

14844	210x150x680 mm (AxBxΓ)	6
-------	------------------------	---



BELLOTA

ΦΤΥΑΡΙ ΣΤΡΟΓΓΥΛΟ 29/2

ΚΩΔΙΚΟΣ ΞΥΛΟΥ 00931

IDEAL

HOT SELLER

02344	260x255 mm (AxB) - 900 gr	10
-------	---------------------------	----



BELLOTA

ΦΤΥΑΡΙ ΚΥΡΤΟ 20/3

ΚΩΔΙΚΟΣ ΞΥΛΟΥ 00139

IDEAL

03590	280x255 mm (AxB) - 1200 gr	10
-------	----------------------------	----



Martin craft

ΦΤΥΑΡΙ ΣΤΡΟΓΓΥΛΟ 22710

ΚΩΔΙΚΟΣ ΞΥΛΟΥ 00931

HOT SELLER

03523	260x255 mm (AxB) - 1000 gr	10
-------	----------------------------	----

■ NEW ARRIVAL ΝΕΑ ΑΦΙΞΗ ■ HOT SELLER ΚΑΛΥΤΕΡΟ ΣΤΗΝ ΠΩΛΗΣΗ ■ GET IT NOW ΑΞΙΖΕΙ ΝΑ ΑΓΟΡΑΣΕΙΣ ΤΩΡΑ



Martin
craft

GET IT NOW

ΦΤΥΑΡΙ ΚΥΡΤΟ 22720

ΚΩΔΙΚΟΣ ΞΥΛΟΥ 00139

03524	300x265 mm (AxB) - 800 gr	10
-------	---------------------------	----



BELLOTA

ΦΤΥΑΡΙ ΛΑΙΜΟΥ 5550-31 SM

ΚΩΔΙΚΟΣ ΞΥΛΟΥ 00139

11972	310x310 mm (AxB) - 1660 gr	6
-------	----------------------------	---



IDEAL

ΦΤΥΑΡΙ ΛΑΙΜΟΥ 77/1

ΚΩΔΙΚΟΣ ΞΥΛΟΥ 00139

13814	310x260 mm (AxB) - 1330 gr	10
-------	----------------------------	----



BELLOTA

ΦΤΥΑΡΙ ΚΥΡΤΟ 3103MFVA ΜΕ ΛΑΒΗ FIBERGLASS

ΚΩΔΙΚΟΣ ΞΥΛΟΥ 00139

09205	300x230x1250 mm (AxBxΓ)	2
-------	-------------------------	---



Martin
craft

ΦΤΥΑΡΙ ΛΑΙΜΟΥ ΤΥΠΟΥ ΓΑΛΛΙΑΣ 22737

ΚΩΔΙΚΟΣ ΞΥΛΟΥ 00139

13782	290x290 mm (AxB) - 1300 gr	10
-------	----------------------------	----



IDEAL

ΦΤΥΑΡΙ ΚΡΗΤΗΣ 4/2

ΚΩΔΙΚΟΣ ΞΥΛΟΥ 00139

04184	270x250 mm (AxB)	10
-------	------------------	----



ΦΤΥΑΡΙΑ

INTER



ΦΤΥΑΡΙ ΚΡΗΤΗΣ

ΚΩΔΙΚΟΣ
ΞΥΛΟΥ
00139

  
12509 260x245 mm (AxB) 12

BELLOTA



ΠΑΤΗΤΟ ΜΥΤΕΡΟ 5557-23 SM

ΚΩΔΙΚΟΣ
ΞΥΛΟΥ
00139

  
09223 300x220 mm (AxB) 5

BELLOTA



ΠΑΤΗΤΟ ΤΕΤΡΑΓΩΝΟ 5573-26 SM

ΚΩΔΙΚΟΣ
ΞΥΛΟΥ
03076

  
07489 260x160 mm (AxB) 12



IDEAL



ΠΑΤΗΤΟ ΜΥΤΕΡΟ 2156/3

ΚΩΔΙΚΟΣ
ΞΥΛΟΥ
07933

  
00965 270x210 mm (AxB) 10



IDEAL



ΠΑΤΗΤΟ ΤΕΤΡΑΓΩΝΟ 2153

ΚΩΔΙΚΟΣ
ΞΥΛΟΥ
07933

  
03591 265x200 mm (AxB) 10



Martin's Craft



ΠΑΤΗΤΟ ΜΥΤΕΡΟ 22730

ΚΩΔΙΚΟΣ
ΞΥΛΟΥ
07933

  
03525 300x230 mm (AxB) 10

■ NEW ARRIVAL ΝΕΑ ΑΦΙΞΗ ■ HOT SELLER ΚΑΛΥΤΕΡΟ ΣΤΗΝ ΠΩΛΗΣΗ ■ GET IT NOW ΑΞΙΖΕΙ ΝΑ ΑΓΟΡΑΣΕΙΣ ΤΩΡΑ



05180 300x240x1040 mm (AxBxΓ) 6

ΠΑΤΗΤΟ ΜΥΤΕΡΟ ΜΕ ΞΥΛΟ



02217 400x115x1020 mm (AxBxΓ) 5

ΠΑΤΗΤΟ ΚΕΡΑΜΙΔΙ ΜΕ ΣΙΔΕΡΕΝΙΟ ΧΕΡΙ



09203 275x220x1450 mm (AxBxΓ) 6

09204 300x195x1500 mm (AxBxΓ) 6

ΠΑΤΗΤΑ ΜΕ FIBERGLASS ΛΑΒΗ

BELLOTA



00845 275x215x1020 mm (AxBxΓ) 5

ΠΑΤΗΤΟ ΤΕΤΡΑΓΩΝΟ ΜΕ ΣΙΔΕΡΕΝΙΟ ΧΕΡΙ



07220 335x265x1030 mm (AxBxΓ) 6

ΦΤΥΑΡΙ ΚΑΡΒΟΥΝΩΝ 5502-3 MM ΜΕ ΛΑΒΗ ΤΥΠΟΥ «Τ»

BELLOTA



ΦΤΥΑΡΙΑ



BELLOTA

ΦΤΥΑΡΙ ΚΑΡΒΟΥΝΩΝ 5502-6 ΜΑ ΜΕ ΛΑΒΗ ΤΥΠΟΥ «Δ»

03083	370x305x1070 mm (AxBxΓ)	6
-------	-------------------------	---



Martin craft

ΦΤΥΑΡΙ ΚΑΡΒΟΥΝΩΝ 22742 ΜΕ FIBERGLASS ΛΑΒΗ

10209	355x285x1150 mm (AxBxΓ)	6
-------	-------------------------	---



Martin craft

ΦΤΥΑΡΙ ΚΑΡΒΟΥΝΩΝ 22740 ΜΕ ΞΥΛΟ

03538	300x240x1150 mm (AxBxΓ)	6
-------	-------------------------	---



BELLOTA

ΦΤΥΑΡΙ ΚΑΡΒΟΥΝΩΝ 3104MFVA ΜΕ FIBERGLASS ΛΑΒΗ

09206	295x240x1230 mm (AxBxΓ)	2
-------	-------------------------	---



BELLOTA

ΦΤΥΑΡΑΚΙΑ FIBERGLASS

09211	2985 φαρδύ - 290x85 mm (ΓxB)	6
09212	2986 στενό - 290x60 mm (ΓxB)	6



BELLOTA

ΦΤΥΑΡΑΚΙΑ ΑΛΟΥΜΙΝΙΟΥ

06808	3001 φαρδύ - 290x80 mm (ΓxB)	6
08348	3000 στενό - 290x60 mm (ΓxB)	6

■ NEW ARRIVAL ΝΕΑ ΑΦΙΞΗ ■ HOT SELLER ΚΑΛΥΤΕΡΟ ΣΤΗΝ ΠΩΛΗΣΗ ■ GET IT NOW ΑΞΙΖΕΙ ΝΑ ΑΓΟΡΑΣΕΙΣ ΤΩΡΑ

ΠΑΤΣΟ 



ΒΑΤΟΚΟΠΑ ΣΦΥΡΗΛΑΤΗ

ΚΩΔΙΚΟΣ ΞΥΛΟΥ **08133**

  
 11282 10

GET IT NOW

ΠΑΤΣΟ 



ΚΑΣΑΡΑ ΒΑΡΕΩΣ ΤΥΠΟΥ

ΚΩΔΙΚΟΣ ΞΥΛΟΥ **11277**

  
 11277 10

GET IT NOW

INTER



ΒΑΤΟΚΟΠΑ

ΚΩΔΙΚΟΣ ΞΥΛΟΥ **06113 ή 01909**

  
 06264 5

GET IT NOW

ΠΑΤΣΟ 



ΚΑΣΑΡΑ ΑΓΡΙΝΟΥ

ΚΩΔΙΚΟΣ ΞΥΛΟΥ **08133**

  
 11279 10

GET IT NOW

ΠΑΤΣΟ 



ΒΑΤΟΚΟΠΑ ΔΡΕΠΑΝΙ ΕΝΙΣΧΥΜΕΝΗ

ΚΩΔΙΚΟΣ ΞΥΛΟΥ **08133**

  
 11281 10

GET IT NOW









ΚΑΣΑΡΑ ΜΕΓΑΛΗ

ΚΩΔΙΚΟΣ ΞΥΛΟΥ **06263**

  
 06263 5

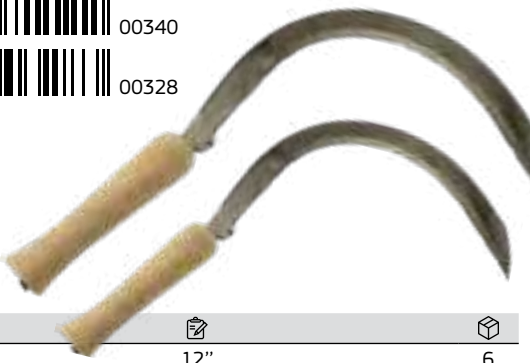
 00340
 00328



ΔΡΕΠΑΝΙ

ΚΩΔΙΚΟΣ ΞΥΛΟΥ **00340** 12" 6
00328 16" 6

ΠΑΤΣΟ 





ΚΑΣΑΡΑ ΜΙΚΡΗ

ΚΩΔΙΚΟΣ ΞΥΛΟΥ **11278**

  
 11278 10



GET IT NOW



ΛΕΛΕΚΙ

ΚΩΔΙΚΟΣ ΞΥΛΟΥ **06113 ή 01909**

  
 09168 5



06333
06334

BELLOTA



ΔΡΕΠΑΝΙ ΜΕ ΔΟΝΤΙ 2550

Barcode	Code	Quantity
06333	code 2550-1	6
06334	code 2550-2	6

02177
00137
02911



ΔΡΕΠΑΝΙ ΜΕΛΙΣΣΑ ΗΠΕΙΡΟΥ

Barcode	Code	Quantity
02177	0	6
00137	1	6
02911	3	6

BELLOTA



ΔΡΕΠΑΝΙ ΜΕ ΔΟΝΤΙ 2552

Barcode	Code	Quantity
11207	code 2552	6

00329
00330
03687



ΔΡΕΠΑΝΙ ΜΕΛΙΣΣΑ ΚΕΡΚΥΡΑΣ

Barcode	Code	Quantity
00329	0	6
00330	1	6
03687	2	5

BELLOTA



ΔΡΕΠΑΝΙ ΧΩΡΙΣ ΔΟΝΤΙ 2562

Barcode	Code	Quantity
03837	code 2562	6



ΔΡΕΠΑΝΙ ΜΕΛΙΣΣΑ ΦΑΡΔΥ

Barcode	Code	Quantity
00331	3	6





**ΧΑΤΖΑΡΙ
ΓΙΑ ΚΑΛΑΜΙΑ**

		
00188	μήκος λάμας 240 mm	6





ΣΠΑΘΑ ΒΛΑΣΤΑΡΙΩΝ 31B-20

		
00437	μήκος λάμας 510 mm	6





ΣΠΑΘΑ ΒΛΑΣΤΑΡΙΩΝ

		
09126	μήκος λάμας 400 mm	6





ΣΠΑΘΑ ΒΛΑΣΤΑΡΙΩΝ

		
04803	μήκος λάμας 370 mm	6



09169



09170



ΚΛΑΔΕΥΤΗΡΙ ΜΕ ΜΕΤΑΛΛΙΚΗ ΛΑΒΗ

		
09169	No 1 μικρό	5
09170	No 2 μεγάλο	5





ΚΛΑΔΕΥΤΗΡΙ ΑΙΓΙΟΥ

		
00436		5





ΚΛΑΔΕΥΤΗΡΙ ΤΡΙΦΥΛΙΑΣ

		
00435		5

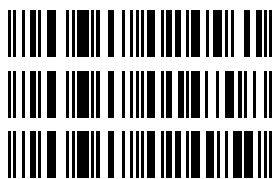

02456

01470

02495

ΤΟΒΑΡΝΑ



GET IT NOW

ΚΟΣΑ ΚΡΟΚΟΔΕΙΛΟΣ

Barcode	Icon	Icon
02456	μήκος 55 cm	5
01470	μήκος 60 cm	5
02495	μήκος 65 cm	5

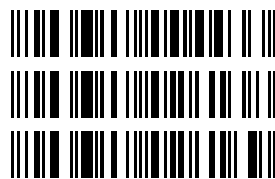

00443

02613

02616



ΚΟΣΑ ΑΥΣΤΡΙΑΣ

Barcode	Icon	Icon
00443	μήκος 55 cm	5
02613	μήκος 60 cm	5
02616	μήκος 65 cm	5



ΚΟΣΑ ΚΙΝΑΣ

Barcode	Icon	Icon
00441	μήκος 60 cm	5



ΚΟΣΑ ΧΕΙΡΟΠΟΙΗΤΗ ΜΕ ΣΩΛΗΝΑ

Barcode	Icon	Icon
04186	μήκος 44 cm	5



ΣΦΥΡΙ & ΑΜΟΝΙ ΚΟΣΑΣ

Barcode	Icon	Icon
00415	σΕΤ	6

ΚΟΣΟΣΙΔΕΡΑ



ΚΟΣΟΣΙΔΕΡΟ ΙΣΙΟ

02138	με θηλιά	5



01715



06787



ΚΟΣΟΣΙΔΕΡΟ Μ2503

01715	με θηλιά	6
06787	θηλιά Α2503	6



ΚΟΣΟΣΙΔΕΡΟ 1,5 m

09276	με θηλιά	10

GET IT NOW

**ΘΗΛΙΑ ΚΟΣΩΝ**

00386



10



05091

03780



03780



05091

GET IT NOW**ΜΑΣΚΑ ΜΕ ΣΙΤΑ ΓΙΑ ΧΛΟΟΚΟΠΤΙΚΑ**

05091

με προστατευτικό ΚΙΝΑΣ



10

03780

ΤΑΪΒΑΝ

30

**GET IT NOW****ΜΑΣΚΑ ΜΕ ΠΛΑΣΤΙΚΟ ΓΙΑ ΧΛΟΟΚΟΠΤΙΚΑ ΤΑΪΒΑΝ**

02993

με προστατευτικό



6



04256



11084



04227



03792



05274



11085



12610



04580



12611



11086



12612



11087



01521



01520



11083



11088



03599



07930

**GET IT NOW**

11083



01521

ΜΕΣΙΝΕΖΕΣ ΧΛΟΟΚΟΠΤΙΚΩΝ

04256

Φ 3,0x50 m - Μαύρες



10

04227

Φ 3,3x50 m - Μαύρες

10

05274

Φ 4,0x50 m - Μαύρες

10

12610

Φ 1,6x15 m

12

12611

Φ 2,0x15 m

12

12612

Φ 2,4x15 m

12

01521

Φ 2,4x50 m

10

11083

Φ 3,0x15 m

12

03599

Φ 3,0x50 m

10

11084

Φ 3,3x15 m

12

03792

Φ 3,3x50 m

10

11085

Φ 4,0x15 m

10

04580

Φ 4,0x50 m

10

11086

Φ 3,0x10 m - Τετράγωνη

12

11087

Φ 3,3x10 m - Τετράγωνη

12

01520

Φ 3,3x50 m - Τετράγωνη

10

11088

Φ 4,0x10 m - Τετράγωνη

12

07930

Φ 4,0x50 m - Τετράγωνη

10

 14724
 14725
 14726
 14410



ΜΕΣΙΝΕΖΑ ΣΤΡΙΦΤΗ ΜΑΥΡΗ

Barcode	Dimensions	Quantity
14724	Φ 3,3 mm x 30 m	12
14725	Φ 3,9 mm x 25 m	12
14726	Φ 4,3 mm x 20 m	12
14410	Φ 4,8 mm x 20 m	12

BLISTER
HOT SELLER
GET IT NOW
NEW ARRIVAL

 14727
 14728



ΜΕΣΙΝΕΖΑ ΣΤΡΟΓΓΥΛΗ STEEL LINE

Barcode	Dimensions	Quantity
14727	Φ 3,3 mm x 30 m	12
14728	Φ 3,9 mm x 25 m	12

BLISTER





ΚΕΦΑΛΗ ΘΑΜΝΟΚΟΠΤΙΚΟΥ UNIVERSAL

Barcode	Description	Quantity
14729	4 εξόδων - αλουμινίου	8

BLISTER
NEW ARRIVAL





ΚΕΦΑΛΗ ΘΑΜΝΟΚΟΠΤΙΚΟΥ UNIVERSAL

Barcode	Description	Quantity
14730	αλουμινίου	8

BLISTER
NEW ARRIVAL





ΚΕΦΑΛΗ ΘΑΜΝΟΚΟΠΤΙΚΟΥ UNIVERSAL

Barcode	Description	Quantity
14731	αλουμινίου - πλαστικού	10

BLISTER
NEW ARRIVAL

 10185
 06009
 08270



ΓΕΩΤΡΥΠΑΝΟ ΜΕ ΣΙΔΕΡΕΝΙΟ ΧΕΡΙ

Barcode	Dimensions	Quantity
10185	Φ 100 mm	1
06009	Φ 150 mm	1
08270	Φ 200 mm	1



ΠΑΤΗΤΟ ΔΙΚΕΛΙ
ΜΕ ΣΙΔΕΡΕΝΙΑ ΛΑΒΗ

06946	240x85x1010 mm (AxBxΓ)	1



ΔΙΚΕΛΙ

ΚΩΔΙΚΟΣ
ΞΥΛΟΥ
03080

11275	200x115 mm (AxB) - 1000 gr	10



ΔΙΚΕΛΙ 22238

ΚΩΔΙΚΟΣ
ΞΥΛΟΥ
01623

10019	260x80 mm (AxB) - 1400 gr	6



ΔΙΚΕΛΙ ΜΥΤΕΡΟ 1018

ΚΩΔΙΚΟΣ
ΞΥΛΟΥ
01623

03482	270x105 mm (AxB) - 1125 gr	12

ΤΡΙΚΕΛΙΑ - ΠΗΡΟΥΝΕΣ



Barcode: [Barcode]

PATCO

ΚΩΔΙΚΟΣ ΞΥΛΟΥ
03080

ΤΡΙΚΕΛΙ

11274 200x140 mm (AxB) - 1000 gr 15



Barcode: [Barcode]

M Martin craft

ΚΩΔΙΚΟΣ ΞΥΛΟΥ
08133

ΠΗΡΟΥΝΑ ΠΑΤΗΤΗ 22630

03522 290x185 mm (AxB) - 4 δόντια 10



Barcode: [Barcode]

BELLOTA

ΚΩΔΙΚΟΣ ΞΥΛΟΥ
05314

ΤΡΙΚΕΛΙ 1020-A

01224 210x115 mm (AxB) - 875 gr 12



Barcode: [Barcode]

BELLOTA

ΚΩΔΙΚΟΣ ΞΥΛΟΥ
08133

ΠΗΡΟΥΝΑ ΠΑΤΗΤΗ 910-4

04187 270x190 mm (AxB) - 4 δόντια 6



Barcode: [Barcode]

BELLOTA

ΚΩΔΙΚΟΣ ΞΥΛΟΥ
08133

ΠΗΡΟΥΝΑ 901-3A

13253 410x270 mm (AxB) - 3 δόντια 6



Barcode: [Barcode]

BELLOTA

ΚΩΔΙΚΟΣ ΞΥΛΟΥ
08133

ΠΗΡΟΥΝΑ ΠΑΤΗΤΗ ΜΕ ΞΥΛΟ 911-4

03607 270x190x1070 mm (AxBxΓ) 2



BELLOTA

ΠΗΡΟΥΝΑ 901-4

ΚΩΔΙΚΟΣ ΞΥΛΟΥ **08133**

03061	320x210 mm (AxB) - 4 δόντια	6

Martin's Craft

03520
03521

ΠΗΡΟΥΝΑ ΑΤΟΦΙΑ

ΚΩΔΙΚΟΣ ΞΥΛΟΥ **08133**

HOT SELLER

03520	300x210 mm (AxB) - 4 δόντια code 22620	10
03521	330x250 mm (AxB) - 5 δόντια code 22625	10

BELLOTA

ΠΗΡΟΥΝΑ 901-5

ΚΩΔΙΚΟΣ ΞΥΛΟΥ **08133**

07485	340x250 mm (AxB) - 5 δόντια	6

ΠΗΡΟΥΝΑ ΚΙΝΑΣ

ΚΩΔΙΚΟΣ ΞΥΛΟΥ **08133**

01021	330x205 mm (AxB) - 4 δόντια	12

BELLOTA

ΠΗΡΟΥΝΑ ΚΥΡΤΗ 903-4

ΚΩΔΙΚΟΣ ΞΥΛΟΥ **08133**

13254	210x210 mm (AxB) - 4 δόντια	6

BELLOTA

ΤΣΟΥΓΚΡΑΝΑ 2951

ΚΩΔΙΚΟΣ ΞΥΛΟΥ **06113 & 01909**

GET IT NOW

03063	318x94 mm (AxB) - 12 δόντια	12
14978	375x94 mm (AxB) - 14 δόντια	12
03065	430x94 mm (AxB) - 16 δόντια	12
12121	542x94 mm (AxB) - 20 δόντια	12



ΤΣΟΥΓΚΡΑΝΑ 3102 ΜΕ ΛΑΒΗ FIBERGLASS

Barcode	Dimensions (AxB)	Teeth	Code	Quantity
05465	335x75 mm	14 δόντια		6
05291	405x75 mm	16 δόντια		6

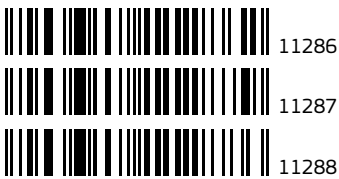

ΤΣΟΥΓΚΡΑΝΑ ΣΦΥΡΗΛΑΤΗ

ΚΩΔΙΚΟΣ
ΣΥΛΟΥ
06113 & 01909

Barcode	Dimensions (AxB)	Teeth	Code	Quantity
11286	345x75 mm	12 δόντια		10
11287	400x85 mm	14 δόντια		10
11288	465x85 mm	16 δόντια		10

GET IT NOW



ΤΣΟΥΓΚΡΑΝΑ

ΚΩΔΙΚΟΣ
ΣΥΛΟΥ
06113 & 01909

Barcode	Dimensions (AxB)	Teeth	Code	Quantity
03516	260x90 mm	10 δόντια	code 22660	12
03517	320x90 mm	12 δόντια	code 22662	12
03518	370x90 mm	14 δόντια	code 22664	12
03519	420x90 mm	16 δόντια	code 22666	12

HOT SELLER

GET IT NOW

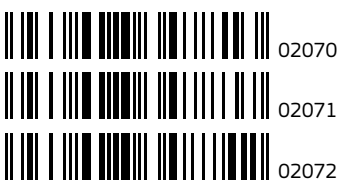

ΤΣΟΥΓΚΡΑΝΑ

ΚΩΔΙΚΟΣ
ΣΥΛΟΥ
06113 & 01909

Barcode	Dimensions (AxB)	Teeth	Code	Quantity
02070	300x80 mm	12 δόντια		6
02071	350x80 mm	14 δόντια		6
02072	400x80 mm	16 δόντια		6

GET IT NOW

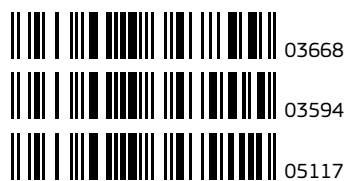

ΤΣΟΥΓΚΡΑΝΑ ΣΤΡΙΦΤΗ

ΚΩΔΙΚΟΣ
ΣΥΛΟΥ
06113 & 01909

Barcode	Dimensions (AxB)	Teeth	Code	Quantity
03668	320x95 mm	12 δόντια		6
03594	380x95 mm	14 δόντια		6
05117	435x95 mm	16 δόντια		6





ΤΣΟΥΓΚΡΑΝΑΚΙΑ - ΦΥΤΕΥΤΗΡΙΑ



BELLOTA

ΤΣΟΥΓΚΡΑΝΑΚΙ ΠΑΛΑΜΗΣ FIBERGLASS 2987

09213	283x80 mm - 3 δόντια	6
-------	----------------------	---



BELLOTA

ΕΡΓΑΛΕΙΑ ΚΗΠΟΥ FIBERGLASS 2994

09215	σετ 3 τμχ	4
-------	-----------	---



BELLOTA

ΤΣΟΥΓΚΡΑΝΑΚΙ ΠΑΛΑΜΗΣ ΑΛΟΥΜΙΝΙΟΥ 2998

08350	280x84 mm - 3 δόντια	6
-------	----------------------	---



BELLOTA

ΤΣΟΥΓΚΡΑΝΑΚΙ ΠΑΛΑΜΗΣ ΑΛΟΥΜΙΝΙΟΥ 3006

06810	302x111 mm - 6 δόντια	6
-------	-----------------------	---



BELLOTA

ΦΥΤΕΥΤΗΡΙ ΒΟΛΒΩΝ 3012

08351	240x125 mm	6
-------	------------	---



BELLOTA

ΤΣΟΥΓΚΡΑΝΑ ΚΗΠΟΥ 3084

ΤΑΙΡΙΑΖΕΙ ΣΤΕΙΛΙΑΡΙ 06113 ή 01909

09210	97x114 mm - 3 δόντια	6
-------	----------------------	---



BELLOTA

ΦΥΤΕΥΤΗΡΙ ΑΛΟΥΜΙΝΙΟΥ 3003

07483	284 mm	6
-------	--------	---

■ NEW ARRIVAL ΝΕΑ ΑΦΙΞΗ ■ HOT SELLER ΚΑΛΥΤΕΡΟ ΣΤΗΝ ΠΩΛΗΣΗ ■ GET IT NOW ΑΞΙΖΕΙ ΝΑ ΑΓΟΡΑΣΕΙΣ ΤΩΡΑ



13152



13140



13141

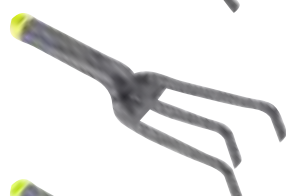

13142

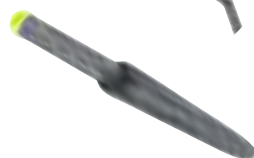

13143

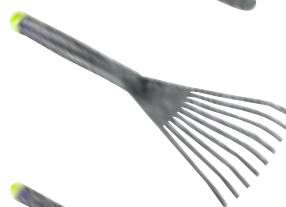

13144



13145



13147



13146



ΚΩΔ: 13152 ΕΚΘΕΤΗΡΙΟ "TERRA" ΜΕ 140 ΕΡΓΑΛΕΙΑ ΚΗΠΟΥ FIBER GLASS

Barcode	Icon	Description	Quantity
13143		εξαγωγέας ριζών	12
13140		ηπρούνα παλάμης με 3 δόντια	12
13147		σέσουλες σετ 3 τμχ.	12
13145		σκαλιστηράκι	8
13144		σκουπάκι φύλλων	12
13141		τσουγκρανάκι παλάμης με 3 δόντια	12
13142		τσουγκρανάκι παλάμης με 3 κυρτά δόντια	12
13138		φτυράκι στενό	24
13139		φτυράκι φαρδύ	24
13146		φτυάρι κήπου	12



ΣΚΟΥΠΕΣ ΦΥΛΛΩΝ



ΣΚΟΥΠΑ ΣΤΑΘΕΡΗ
ΚΩΔΙΚΟΣ ΞΥΛΟΥ 01909
 01245  22681  6



ΣΚΟΥΠΑ ΡΥΘΜΙΖΟΜΕΝΗ ΜΕ ΑΓΚΙΣΤΡΟ
ΚΩΔΙΚΟΣ ΞΥΛΟΥ 01909
 13464  22680  6











ΣΚΟΥΠΑ ΣΤΑΘΕΡΗ ΒΑΡΕΩΣ ΤΥΠΟΥ
ΚΩΔΙΚΟΣ ΞΥΛΟΥ 01909
 10208  22682  6



ΣΚΟΥΠΑ ΡΥΘΜΙΖΟΜΕΝΗ ΜΕ ΑΓΚΙΣΤΡΟ ΤΑΪΒΑΝ
ΚΩΔΙΚΟΣ ΞΥΛΟΥ 01909
 01928  22680  5





ΣΚΟΥΠΑ ΡΥΘΜΙΖΟΜΕΝΗ
ΚΩΔΙΚΟΣ ΞΥΛΟΥ 01909
 07484  3042  6



ΣΚΟΥΠΑ ΡΥΘΜΙΖΟΜΕΝΗ ΚΩΝΙΚΗ ΤΑΪΒΑΝ
ΚΩΔΙΚΟΣ ΞΥΛΟΥ 01909
 01357  22680  5

■ NEW ARRIVAL ΝΕΑ ΑΦΙΞΗ ■ HOT SELLER ΚΑΛΥΤΕΡΟ ΣΤΗΝ ΠΩΛΗΣΗ ■ GET IT NOW ΑΞΙΖΕΙ ΝΑ ΑΓΟΡΑΣΕΙΣ ΤΩΡΑ



GET IT NOW

ΣΚΟΥΠΑ ΡΥΘΜΙΖΟΜΕΝΗ ΜΕ ΚΟΝΤΑΡΙ

10206	22683	6

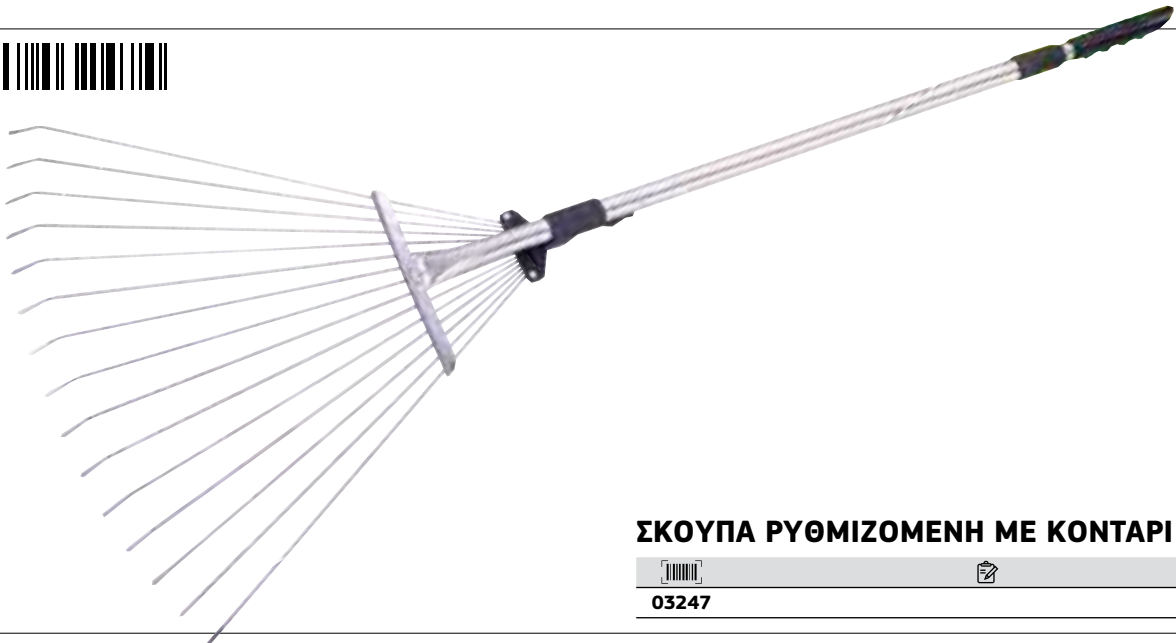

GET IT NOW

ΣΚΟΥΠΑ ΡΥΘΜΙΖΟΜΕΝΗ ΜΕ ΚΟΝΤΑΡΙ ΤΑΪΒΑΝ

03247		12

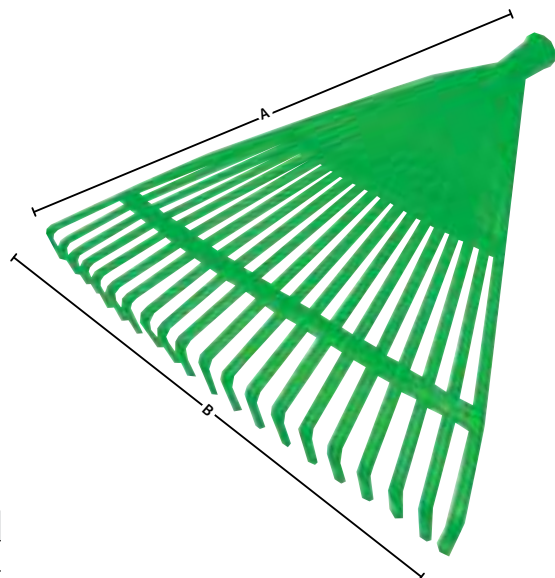

ΣΚΟΥΠΑ ΣΤΑΘΕΡΗ ΠΛΑΣΤΙΚΗ

09307	415x450 mm (AxB)	5





ΤΣΟΥΓΚΡΑΝΕΣ ΠΛΑΣΤΙΚΕΣ

04346

06836

05464





ΤΣΟΥΓΚΡΑΝΑ ΓΥΡΙΣΤΗ ΜΕ ΛΑΒΗ ΑΛΟΥΜΙΝΙΟΥ

ΚΩΔΙΚΟΣ	ΠΕΡΙΓΡΑΦΗ	ΠΟΣΗ
04346	κομπλέ 1460x430mm	10
06836	ανταλλακτικό 430mm	10
05464	χειρολαβή 1250mm	10

GET IT NOW

09308





ΤΣΟΥΓΚΡΑΝΑ ΠΛΑΣΤΙΚΗ ΜΕ ΚΥΡΤΑ ΔΟΝΤΙΑ

ΚΩΔΙΚΟΣ ΞΥΛΟΥ 01909

ΚΩΔΙΚΟΣ	ΠΕΡΙΓΡΑΦΗ	ΠΟΣΗ
09308	δόντια 22 - 575x110 mm (AxB)	10

09309





ΤΣΟΥΓΚΡΑΝΑ ΠΛΑΣΤΙΚΗ ΜΕ ΙΣΙΑ ΔΟΝΤΙΑ

ΚΩΔΙΚΟΣ ΞΥΛΟΥ 01909

ΚΩΔΙΚΟΣ	ΠΕΡΙΓΡΑΦΗ	ΠΟΣΗ
09309	δόντια 18 - 550x90 mm (AxB)	10

08966





ΤΣΟΥΓΚΡΑΝΑ ΠΛΑΣΤΙΚΗ ΓΙΑ ΕΛΙΕΣ

ΚΩΔΙΚΟΣ ΞΥΛΟΥ 01909

ΚΩΔΙΚΟΣ	ΠΕΡΙΓΡΑΦΗ	ΠΟΣΗ
08966	395x170 mm (AxB)	10

05379

05556

00730





ΤΣΟΥΓΚΡΑΝΕΣ ΠΛΑΣΤΙΚΕΣ

ΚΩΔΙΚΟΣ ΞΥΛΟΥ 01909

ΚΩΔΙΚΟΣ	ΠΕΡΙΓΡΑΦΗ	ΠΟΣΗ
05379	Κωδ. Νο 106 - 300x150 mm (AxB)	10
05556	Κωδ. Νο 109 - 450x100 mm (AxB)	10
00730	Κωδ. Νο 111 - 470x140 mm (AxB)	10

■ NEW ARRIVAL ΝΕΑ ΑΦΙΞΗ ■ HOT SELLER ΚΑΛΥΤΕΡΟ ΣΤΗΝ ΠΩΛΗΣΗ ■ GET IT NOW ΑΞΙΖΕΙ ΝΑ ΑΓΟΡΑΣΕΙΣ ΤΩΡΑ

ΓΡΑΒΑΛΑ - ΦΡΟΥΤΟΣΥΛΛΕΚΤΕΣ



05184
09355



ΓΡΑΒΑΛΟ ΕΛΑΙΩΝ ΜΕ ΧΩΝΙ ΠΛΑΣΤΙΚΟ

		
05184	μικρό - 130x70 mm (AxB)	20
09355	μεγάλο - 130x80 mm (AxB)	20





ΓΡΑΒΑΛΟ ΕΛΑΙΩΝ ΜΕΓΑΛΟ

		
00275	130x120 mm (AxB)	25

GET IT NOW





ΓΡΑΒΑΛΟ ΣΤΑΦΙΔΑΣ

		
00276	Κωδ. Νο 107 - 320x130 mm (AxB)	10





ΓΡΑΒΑΛΟ ΕΛΑΙΩΝ ΜΙΚΡΟ

		
00274	120x85 (AxB)	25

GET IT NOW





ΓΡΑΒΑΛΟ ΕΛΑΙΩΝ ΕΠΙΔΑΥΡΟΥ

		
01200	Κωδ. Νο 104 - 130x150 mm (AxB)	25





ΦΡΟΥΤΟΣΥΛΛΕΚΤΗΣ ΠΛΑΣΤΙΚΟΣ

		
09277	ρυθμιζόμενη κεφαλή	5



06308
06322

ΡΑΒΔΙΣΤΗΡΙ Μ5 ΜΕ ΠΛΑΣΤΙΚΗ ΛΑΒΗ

Barcode	Icon	Icon
06308	μήκος 800 mm	10
06322	ανταλλακτικό 370x140 mm	10

08511
08512

ΡΑΒΔΙΑ ΜΗΧΑΝΗΣ

Barcode	Icon	Icon
08511	απλά - 120/110 mm (A/B)	100
08512	κουμπωτά - 160/130 mm (A/B)	100

03317
08832

ΣΑΚΟΣ ΥΦΑΝΤΟΣ ΓΚΡΙ

Barcode	Icon	Icon
03317	55x105 cm (πλάτος x μήκος)	100
08832	60x110 cm (πλάτος x μήκος)	100

06408
06293
06294
06295
06345

06296
06321
06329
06830



ΡΑΒΔΙΣΤΗΡΙ ΑΛΟΥΜΙΝΙΟΥ

ΚΩΔΙΚΟΣ ΞΥΛΟΥ 00946 & 00947

Barcode	Icon	Icon
06408	μήκος κονταριού 1,0 m	10
06293	μήκος κονταριού 1,5 m	10
06294	μήκος κονταριού 2,0 m	10
06295	μήκος κονταριού 2,5 m	10
06296	μήκος κονταριού 3,0 m	10
06321	μήκος κονταριού 3,5 m	10
06329	μήκος κονταριού 4,0 m	10
06830	μήκος κονταριού 5,0 m	10

ΡΑΒΔΙΣΤΗΡΙ Μ5 ΜΕ ΛΑΒΗ ΑΛΟΥΜΙΝΙΟΥ



Barcode	Icon	Icon
06345	μήκος 800 mm	10

-  14298
-  14299
-  14300
-  14301

NEW
ARRIVAL





ΕΛΑΙΟΔΙΧΤΟ SUPER ΟΛΙΒΙΑ ΜΕ ΕΝΙΣΧΥΣΗ ΠΕΡΙΜΕΤΡΙΚΑ (100gr/m²)

		
14298	6x12 m (πλάτος x μήκος)	10
14299	7x14 m (πλάτος x μήκος)	8
14300	8x12 m (πλάτος x μήκος)	8
14301	8x14 m (πλάτος x μήκος)	6

-  08822  08828
-  08823  08829
-  08824  11327
-  08825  08830
-  08826  08831
-  08827



ΕΛΑΙΟΔΙΧΤΟ ΟΛΙΒΙΑ ΜΕ ΕΝΙΣΧΥΣΗ ΠΕΡΙΜΕΤΡΙΚΑ (90gr/m²)

		
08822	4x8 m (πλάτος x μήκος)	12
08823	5x8 m (πλάτος x μήκος)	15
08824	5x10 m (πλάτος x μήκος)	12
08825	5x12 m (πλάτος x μήκος)	5
08826	6x10 m (πλάτος x μήκος)	10
08827	6x12 m (πλάτος x μήκος)	8
08828	6x14 m (πλάτος x μήκος)	4
08829	7x12 m (πλάτος x μήκος)	3
11327	7x14 m (πλάτος x μήκος)	3
08830	8x12 m (πλάτος x μήκος)	6
08831	8x14 m (πλάτος x μήκος)	6



ΚΟΣΚΙΝΟ ΔΙΑΛΟΓΗΣ ΓΙΑ ΕΛΙΕΣ

		
02304		2



- Κινούμενο κόσκινο ελιάς και ξηρών καρπών με στρογγυλές θυρίδες στη σκάφη και παραλληλόγραμμα στη λεκάνη συλλογής καρπού.
- Στιβαρή κατασκευή, γαλβανιζέ σκάφη και λεκάνη συλλογής με παραλληλόγραμμη διάτρηση.
- Λυόμενα πόδια για εύκολη μεταφορά και αποθήκευση και 2 μεγάλες χειρολαβές για εύκολη χρήση και μεταφορά.
- Αμεσο σάκισμα από την πλαϊνή έξοδο για το σάκο συλλογής, με γάντζους ανάρτησης.
- Τύπος: κινούμενο
- Είδος λεκάνης: στρογγυλό κόσκινο
- Χρώμα: γαλβανιζέ και κόκκινο
- Διαστάσεις (ΜxΠxΥ): 102x62x82 cm



ΜΗΧΑΝΗΜΑ ΔΙΑΛΟΓΗΣ ΕΛΑΙΟΚΑΡΠΟΥ



13505



1

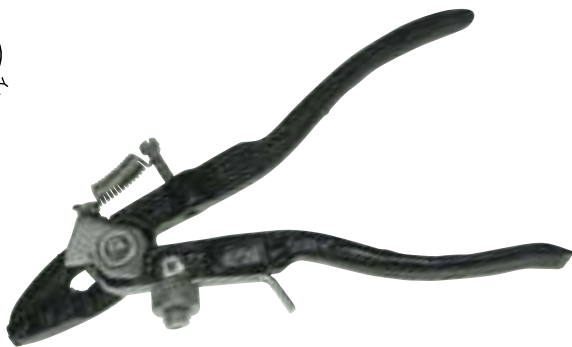

ΤΣΑΠΡΑΖΟΛΟΓΟΣ ΠΕΝΣΑ



01896



12



ΣΟΥΓΙΑΣ ΚΕΝΤΡΩΜΑΤΟΣ (ΜΕ ΝΥΧΙ)



08745



μήκος λάμας 60 mm



20

05101
09391



ΣΟΥΓΙΑΣ ΠΛΑΣΤΙΚΗ ΛΑΒΗ

05101	μήκος λάμας 70 mm	10
09391	μήκος λάμας 100 mm	10





ΣΟΥΓΙΑΣ ΤΥΠΟΥ ΙΩΑΝΝΙΝΩΝ ΠΛΑΣΤΙΚΗ ΛΑΒΗ

12476	μήκος λάμας 100 mm	10





ΣΟΥΓΙΑΣ ΚΕΝΤΡΩΜΑΤΟΣ P11 (ΜΕ ΝΥΧΙ)

02291	μήκος λάμας 60 mm	6





ΣΟΥΓΙΑΣ ΚΕΝΤΡΩΜΑΤΟΣ ΠΛΑΣΤΙΚΗ ΛΑΒΗ

08238	μήκος λάμας 70 mm	12





ΤΣΕΚΜΕΣ ΜΕ ΠΛΑΣΤΙΚΗ ΛΑΒΗ

06224	μήκος λάμας 4,5"	6

03530
03531





ΤΣΕΚΜΕΣ ΜΕ ΞΥΛΙΝΗ ΛΑΒΗ

03530	μήκος λάμας 3,5"	6
03531	μήκος λάμας 5,5"	6





ΤΣΕΚΜΕΣ ΜΕ ΠΛΑΣΤΙΚΗ ΛΑΒΗ ΙΝΟΧ ΛΑΜΑ

14993	μήκος λάμας 4,0"	10

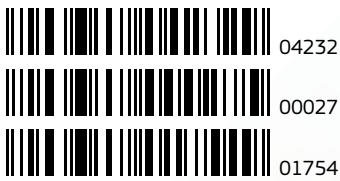

ΦΑΛΤΣΕΤΑ

Barcode	Icon	Quantity
04232	μικρή	6
00027	μεσαία	6
01754	μεγάλη	6



ΦΑΛΤΣΕΤΑ ΧΑΡΑΚΩΜΑΤΟΣ

Barcode	Icon	Quantity
00021		6



ΨΑΛΙΔΑ ΧΑΡΑΚΩΜΑΤΟΣ ΕΛΑΤΗΡΙΟΥ

Barcode	Icon	Quantity
09080	No 1 - μικρή	10
03979	No 3 - μεγάλη	10



ΣΥΡΜΑ ΛΟΥΛΟΥΔΙΩΝ

Barcode	Icon	Quantity
05762	μήκος 30 m - άσπρο	30



ΣΥΡΜΑ ΛΟΥΛΟΥΔΙΩΝ

Barcode	Icon	Quantity
00813	μήκος 30 m - πράσινο	30

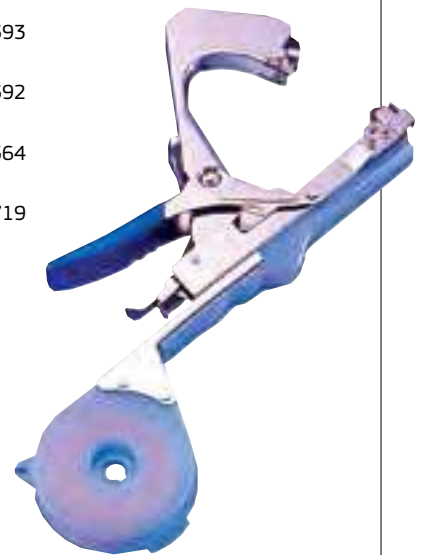

ΔΕΤΙΚΟ ΛΟΥΛΟΥΔΙΩΝ

Barcode	Icon	Quantity
05828	μηχανισμός	2
06393	καρφωτικά (πάκο 10.000 τεμ.)	1
06392	ταινίες κόκκινες	20
07564	ταινίες πράσινες	20
12719	ταινίες μπλε	20

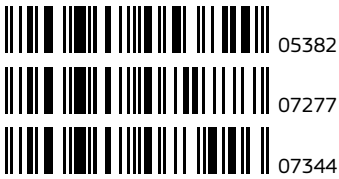

ΦΥΛΛΟ ΠΟΛΥΑΙΘΥΛΕΝΙΟΥ

Barcode	Weight	Unit
05382	βάρος 500 gr	12 kg
07277	βάρος 1000 gr	10 kg
07344	βάρος 5000 gr	5 kg



ΣΩΛΗΝΑΣ ΔΕΝΔΡΟΚΟΜΙΑΣ

Barcode	Weight	Unit
06738	Φ 2 mm - πλεξούδα	kg
06739	Φ 3 mm - πλεξουδα	kg
15235	Φ 3 mm X 10 m - καρτέλα	6
15236	Φ 4,5 mm X 5 m - καρτέλα	6
09321	Φ 5 mm x 5 m - καρτέλα	12

NEW ARRIVAL

09321

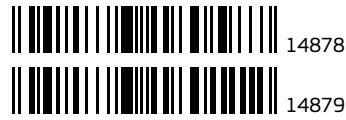

BLISTER

NEW ARRIVAL

ΣΩΛΗΝΑΣ ΔΕΝΔΡΟΚΟΜΙΑΣ

Barcode	Weight	Unit
14878	Φ 3 mm - 0,5 kg - κουβάρι	20
14879	Φ 3 mm - 1,0 kg - κουβάρι	12

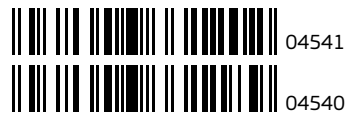

GET IT NOW

04540

04541

ΤΣΕΚΟΥΡΙ ΜΕ ΛΑΒΗ FIBERGLASS

Barcode	Weight	Unit
04541	βάρος 700 gr	6
04540	βάρος 1400 gr	6



GET IT NOW

ΤΣΕΚΟΥΡΙ ΜΕ ΛΑΒΗ ΞΥΛΟ-FIBERGLASS

Barcode	Weight	Unit
09354	βάρος 600 gr	6



INTER

ΤΣΕΚΟΥΡΙ ΜΕ ΛΑΒΗ FIBERGLASS

Barcode	Weight	Unit
10057	βάρος 600 gr	6





ΤΣΕΚΟΥΡΙΑ ΛΙΑΤΑ ΜΕ ΞΥΛΟ

		
01886	βάρος 600 gr	5





ΤΣΕΚΟΥΡΙΑ ΕΛΑΙΩΝ ΜΕ ΞΥΛΟ

ΚΩΔΙΚΟΣ ΞΥΛΟΥ 03665

		
01572	βάρος 450 gr	5





ΤΣΕΚΟΥΡΙΑ ΛΙΑΤΑ ΜΕ ΞΥΛΟ 22350

		
03515	βάρος 560 gr	4





09454
02387
00769
01590

ΤΣΕΚΟΥΡΙΑ ΛΙΑΤΑ

ΚΩΔΙΚΟΣ ΞΥΛΟΥ 00944 από Νο 0 έως Νο 2 07335 στο Νο 3

		
09454	No 0 - βάρος 600 gr	5
02387	No 1 - βάρος 900 gr	5
00769	No 2 - βάρος 1000 gr	5
01590	No 3 - βάρος 1200 gr	5





ΤΣΕΚΟΥΡΙΑ 8130

		
00908	βάρος 300 gr	6









01967
01577

ΤΣΕΚΟΥΡΙΑ ΣΦΗΝΑ

ΚΩΔΙΚΟΣ ΞΥΛΟΥ 03079

		
01967	7" μικρό - βάρος 2800 gr	2
01577	8" μεγάλο - βάρος 3450 gr	2

 08604
 08605



ΚΩΔΙΚΟΣ ΞΥΛΟΥ
07335 στο Νο 3
08862 στο Νο 5

ΤΣΕΚΟΥΡΙΑ ΜΕ ΤΡΙΓΩΝΙΚΗ ΜΑΝΑ

ΚΩΔΙΚΟΣ	Περιγραφή	Μετρήσεις	Ποσότητα
08604	No 3 - βάρος 1400 gr		2
08605	No 5 - βάρος 1800 gr		2

 01573
 01575
 01576
 01887
 08603



ΚΩΔΙΚΟΣ ΞΥΛΟΥ
05313 στο Νο 1
03079 στα Νο 2 έως Νο 6

ΤΣΕΚΟΥΡΙΑ

ΚΩΔΙΚΟΣ	Περιγραφή	Μετρήσεις	Ποσότητα
01573	No 1 - βάρος 400 gr		5
01575	No 2 - βάρος 850 gr		5
01576	No 3 - βάρος 1400 gr		5
01887	No 5 - βάρος 2000 gr		3
08603	No 6 - βάρος 2300 gr		2





ΚΩΔΙΚΟΣ ΞΥΛΟΥ
06269

ΤΣΕΚΟΥΡΙΑ ΣΦΗΝΑ ΜΕ ΞΥΛΙΝΗ ΛΑΒΗ 5460-3

ΚΩΔΙΚΟΣ	Περιγραφή	Μετρήσεις	Ποσότητα
02364	βάρος 3000 gr		6

 01164
 04359
 05278



ΚΩΔΙΚΟΣ ΞΥΛΟΥ

ΤΣΕΚΟΥΡΙΑ ΣΦΗΝΑ ΜΕ ΛΑΒΗ FIBERGLASS

ΚΩΔΙΚΟΣ	Περιγραφή	Μετρήσεις	Ποσότητα
01164	βάρος 3000 gr		4
04359	βάρος 3500 gr		4
05278	σπειρίδι (ανταλλακτικό)		5

GET IT NOW









ΚΩΔΙΚΟΣ ΞΥΛΟΥ

ΣΦΗΝΑ ΣΤΡΙΦΤΗ

ΚΩΔΙΚΟΣ	Περιγραφή	Μετρήσεις	Ποσότητα
09359	βάρος 2500 gr		5

 01421
 01422
 02281



ΚΩΔΙΚΟΣ ΞΥΛΟΥ

ΣΦΗΝΑ

ΚΩΔΙΚΟΣ	Περιγραφή	Μετρήσεις	Ποσότητα
01421	3LB (βάρος 1360 gr)		5
01422	4LB (βάρος 1815 gr)		6
02281	5LB (βάρος 2268 gr)		5

GET IT NOW



ΤΣΕΚΟΥΡΟΣΤΕΝΕΣ - ΤΣΕΚΟΥΡΟΚΑΣΜΑΔΑΚΙΑ





ΤΣΕΚΟΥΡΟΣΤΕΝΗ 801-0

ΚΩΔΙΚΟΣ ΞΥΛΟΥ 03079 ή 05315

		
03147	395x85 mm (AxB) - 2400 gr	6





ΤΣΕΚΟΥΡΟΣΤΕΝΗ

ΚΩΔΙΚΟΣ ΞΥΛΟΥ 03080

		
11272	330x80 mm (AxB) - 1100 gr	10





ΤΣΕΚΟΥΡΟΣΤΕΝΗ 240

ΚΩΔΙΚΟΣ ΞΥΛΟΥ 04160

		
09202	265x75 mm (AxB) - 800 gr	6





ΤΣΕΚΟΥΡΟΣΤΕΝΗ 22215

ΚΩΔΙΚΟΣ ΞΥΛΟΥ 03080

		
03510	380x60 mm (AxB) - 2000 gr	6





ΤΣΕΚΟΥΡΟΣΤΕΝΗ 805-A

ΚΩΔΙΚΟΣ ΞΥΛΟΥ 05315

		
05600	383x64 mm (AxB) - 2000 gr	6





ΤΣΕΚΟΥΡΟΣΤΕΝΗ ΜΙΚΡΗ Β'

ΚΩΔΙΚΟΣ ΞΥΛΟΥ 01623

		
01579	265x56 mm (AxB) - 700 gr	5





ΤΣΕΚΟΥΡΟΚΑΣΜΑΔΑΚΙ 5932-ΑΝ ΜΕ ΞΥΛΟ 33 cm

ΚΩΔΙΚΟΣ ΞΥΛΟΥ 05315

		
05846	290x42 mm (AxB) - 600 gr	6





ΚΑΣΜΑΔΑΚΙ ΜΙΚΡΟ 5933-ΟΝ ΜΕ ΞΥΛΟ 30 cm

ΚΩΔΙΚΟΣ ΞΥΛΟΥ 12371

		
03135	270x39 mm (AxB) - 450 gr	6

■ NEW ARRIVAL ΝΕΑ ΑΦΙΞΗ ■ HOT SELLER ΚΑΛΥΤΕΡΟ ΣΤΗΝ ΠΩΛΗΣΗ ■ GET IT NOW ΑΞΙΖΕΙ ΝΑ ΑΓΟΡΑΣΕΙΣ ΤΩΡΑ

ΠΡΙΟΝΙΑ ΚΛΑΔΟΥ

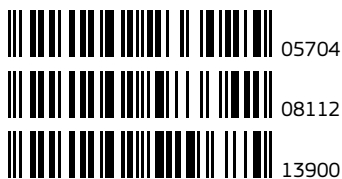

BELLOTA



ΠΡΙΟΝΙ ΚΛΑΔΟΥ 4589

ΔΙΑΤΙΘΕΤΑΙ
ΜΕ ΘΗΚΗ

Code	Description	Quantity
05704	code 4589-9 - μήκος λάμας 230 mm	6
08112	code 4589-12 - μήκος λάμας 305 mm	6
13900	λάμα ανταλλακτική - μήκος 230 mm	6



BELLOTA



ΠΡΙΟΝΙ ΣΟΥΓΙΑΣ 4586-7C

Code	Description	Quantity
07757	μήκος λάμας 180 mm	6

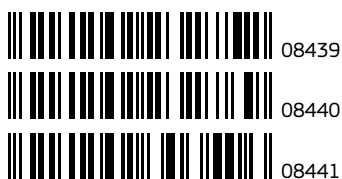

BELLOTA



ΠΡΙΟΝΙ ΚΛΑΔΟΥ 4581

Code	Description	Quantity
08439	code 4581-12 - μήκος λάμας 300 mm	6
08440	code 4581-14 - μήκος λάμας 350 mm	6
08441	code 4581-16 - μήκος λάμας 400 mm	6



BELLOTA



ΠΡΙΟΝΙ ΚΛΑΔΟΥ 4570-10

ΔΙΑΤΙΘΕΤΑΙ
ΜΕ ΘΗΚΗ

Code	Description	Quantity
10175	μήκος λάμας 250 mm	6



BELLOTA



ΠΡΙΟΝΙ ΚΛΑΔΟΥ 4588-13

ΔΙΑΤΙΘΕΤΑΙ
ΜΕ ΘΗΚΗ

Code	Description	Quantity
06652	μήκος λάμας 330 mm	6



BELLOTA

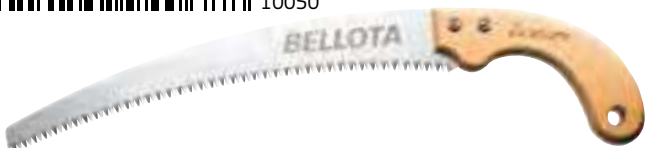

ΠΡΙΟΝΙ ΚΛΑΔΟΥ 4587

ΔΙΑΤΙΘΕΤΑΙ
ΜΕ ΘΗΚΗ

Code	Description	Quantity
03237	code 4587-11 - μήκος λάμας 280 mm	6
03223	code 4587-13 - μήκος λάμας 330 mm	6
10049	λάμα ανταλλακτική - μήκος 280 mm	6
10050	λάμα ανταλλακτική - μήκος 330 mm	6

GET IT
NOW



BELLOTA



ΕΚΘΕΤΗΡΙΟ ΠΡΙΟΝΙΩΝ ΚΛΑΔΟΥ

Code	Description	Quantity
07756		1



ΠΡΙΟΝΙΑ ΚΛΑΔΟΥ

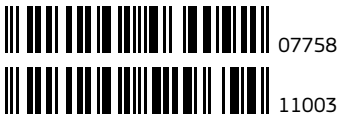

ΠΡΙΟΝΙ ΜΕ ΜΕΤΑΛΛΙΚΟ ΧΩΝΙ 4587-13

07758	μήκος λάμας 330 mm	6
11003	λάμα H4588-13	6



ΠΡΙΟΝΙ ΓΑΤΖΟΥ 4580-13

08310	μήκος λάμας 330 mm	6



ΚΟΝΤΑΡΙ ΠΡΙΟΝΙΩΝ ΠΤΥΣΣΟΜΕΝΟ 3630

08380	μήκος ανοίγματος 1790-2800 mm	3



ΚΟΝΤΑΡΙ ΠΡΙΟΝΙΩΝ ΠΤΥΣΣΟΜΕΝΟ ΤΑΪΒΑΝ

11426	μήκος ανοίγματος 1630-3000 mm	5



ΠΡΙΟΝΙ ΚΛΑΔΟΥ ΜΕ ΠΛΑΣΤΙΚΗ ΛΑΒΗ

ΔΙΑΤΙΘΕΤΑΙ ΜΕ ΘΗΚΗ

03723	code 5124-JS-H - μήκος λάμας 240 mm	4
04574	code 5128-JS-H - μήκος λάμας 280 mm	4

ΑΝΤΑΛΛΑΚΤΙΚΕΣ ΛΑΜΕΣ JS

03682	code 5724-JS - μήκος λάμας 240 mm	1
04670	code 5728-JS - μήκος λάμας 280 mm	1

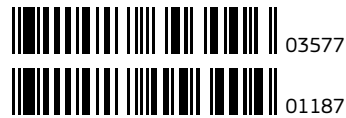

ΠΡΙΟΝΙ ΣΟΥΓΙΑΣ 396-HP

03577	μήκος λάμας 190 mm	4
01187	λάμα ανταλλακτική	1



ΠΡΙΟΝΙ ΚΛΑΔΟΥ ΜΕ ΞΥΛΙΝΗ ΛΑΒΗ

05920	code 4212-11-6T - μήκος λάμας 280 mm	4
04349	code 4212-14-6T - μήκος λάμας 360 mm	4

ΚΟΝΤΑΡΟΠΡΙΟΝΟ ΓΑΝΤΖΟΥ - ΠΡΙΟΝΙΑ ΚΛΑΔΟΥ



ΚΟΝΤΑΡΟΠΡΙΟΝΟ ΓΑΝΤΖΟΥ ΚΥΡΤΟ ΜΕ ΚΟΝΤΑΡΙ ΤΗΛΕΣΚΟΠΙΚΟ 3014

14753	μήκος ανοίγματος 1600-3000 mm	1



NEW
ARRIVAL



ΠΡΙΟΝΙ ΚΛΑΔΟΥ 21010

03534	μήκος λάμας 180 mm	6



ΠΡΙΟΝΙ ΚΛΑΔΟΥ

ΔΙΑΤΙΘΕΤΑΙ
ΜΕ ΘΗΚΗ

03535	code 21002 - μήκος λάμας 240 mm	6
03536	code 21004 - μήκος λάμας 300 mm	6



ΠΡΙΟΝΙ ΣΟΥΓΙΑΣ 21020

13331	μήκος λάμας 180 mm	6



ΠΡΙΟΝΙ ΚΥΡΤΟ 1137 ΜΕ ΞΥΛΙΝΗ ΛΑΒΗ

02047	μήκος λάμας 330 mm	10
01335	λάμα ανταλλακτική - μήκος 330 mm	5

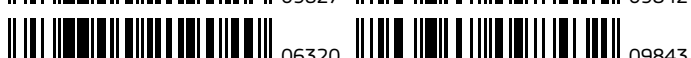

ΠΡΙΟΝΙ ΙΣΙΟ ΜΕ ΞΥΛΙΝΗ ΛΑΒΗ 1016

09626	μήκος λάμας 210 mm	10
09627	μήκος λάμας 240 mm	10
06320	μήκος λάμας 300 mm	10
09841	λάμα ανταλλακτική - μήκος 210 mm	5
09842	λάμα ανταλλακτική - μήκος 240 mm	5
09843	λάμα ανταλλακτική - μήκος 300 mm	5



ΠΡΙΟΝΙ ΙΣΙΟ ΜΕ ΞΥΛΙΝΗ ΛΑΒΗ ΣΕ ΚΑΡΤΕΛΑ 1013

00999	μήκος λάμας 210 mm	10
09624	μήκος λάμας 240 mm	10
01017	μήκος λάμας 300 mm	10
02575	λάμα ανταλλακτική - μήκος 210 mm	5
09625	λάμα ανταλλακτική - μήκος 240 mm	5
02350	λάμα ανταλλακτική - μήκος 300 mm	5

GET IT NOW

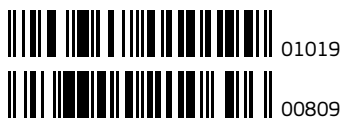

ΠΡΙΟΝΙ ΜΑΥΡΟ ΜΕ ΠΛΑΣΤΙΚΗ ΛΑΒΗ 1139

01019	μήκος λάμας 330 mm	6
00809	λάμα ανταλλακτική - μήκος 330 mm	5



ΠΡΙΟΝΙ ΚΛΑΔΟΥ EX-PRO

ΔΙΑΤΙΘΕΤΑΙ ΜΕ ΘΗΚΗ

02494	μήκος λάμας 300 mm	10



ΠΡΙΟΝΙ ΙΣΙΟ 1125 ΜΕ ΠΛΑΣΤΙΚΗ ΛΑΒΗ

ΔΙΑΤΙΘΕΤΑΙ ΜΕ ΘΗΚΗ

10459	μήκος λάμας 240 mm	10



ΘΗΚΗ ΠΡΙΟΝΙΩΝ

05802	για το 1139-330	10



ΠΡΙΟΝΙ ΓΑΝΤΖΟΥ 1155

05639	μήκος λάμας 350 mm	6
04344	λάμα ανταλλακτική - μήκος 350 mm	5

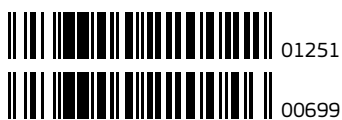

ΠΡΙΟΝΙ ΜΕ ΣΙΔΕΡΕΝΙΑ ΛΑΒΗ 1135

HOT SELLER

01251	μήκος λάμας 330 mm	6
00699	λάμα ανταλλακτική - μήκος 330 mm	5

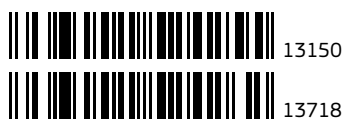

ΠΡΙΟΝΙ ΚΛΑΔΟΥ FS-270 ΜΕ ΜΕΣΑΙΟ ΔΟΝΤΙ

ΔΙΑΤΙΘΕΤΑΙ ΜΕ ΘΗΚΗ

13150	μήκος λάμας 270 mm	6
13718	λάμα ανταλλακτική - μήκος 270 mm	6



GET IT NOW



ΠΡΙΟΝΙ ΚΟΥ ΚJE ΜΕ ΧΟΝΤΡΟ ΔΟΝΤΙ (AG)

(AG) = Ειδικά επεξεργασμένη λάμα για ταχύτερο κόψιμο

Code	Description	Quantity
08304	code KJE-250AG - μήκος λάμας 250 mm	12
10559	code KJE-300AG - μήκος λάμας 300 mm	12
08305	λάμα ανταλλακτική - μήκος 250 mm	20
10590	λάμα ανταλλακτική - μήκος 300 mm	20

ΠΡΙΟΝΙ ΚΟΥ ΚJE ΜΕ ΧΟΝΤΡΟ ΔΟΝΤΙ (BG)

Code	Description	Quantity
05799	code KJE-250BG - μήκος λάμας 250 mm	12
02393	code KJE-250BG - μήκος λάμας 300 mm	12
05819	λάμα ανταλλακτική - μήκος 250 mm	20
05820	λάμα ανταλλακτική - μήκος 300 mm	20

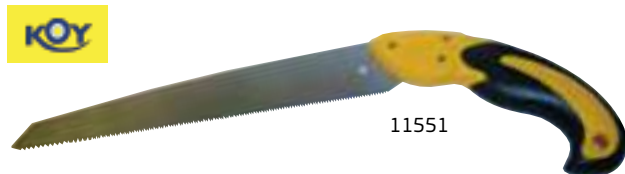
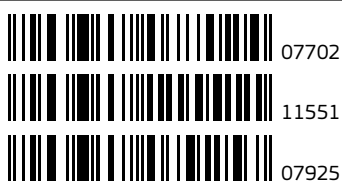

ΠΡΙΟΝΙ ΚΟΥ ΜΕ ΜΕΣΑΙΟ ΔΟΝΤΙ ΚΑΙ ΚΟΥΜΠΩΤΗ ΛΑΜΑ

το πριόνι 07702 ΔΙΑΤΙΘΕΤΑΙ ΜΕ ΘΗΚΗ

Code	Description	Quantity
07702	code KEGD-250J - μήκος λάμας 250 mm	12
11551	code KE0-250J - μήκος λάμας 250 mm	12
07925	λάμα κουμπωτή	15



ΠΡΙΟΝΙ ΚΟΥ ΜΕ ΨΙΛΟ ΔΟΝΤΙ

Code	Description	Quantity
07701	code KPG-250 - μήκος λάμας 250 mm	12
08129	λάμα ανταλλακτική - μήκος 250 mm	15



ΘΗΚΗ ΠΡΙΟΝΙΩΝ ΚΟΥ ΜΕ ΧΟΝΤΡΟ ΔΟΝΤΙ

Code	Description	Quantity
11547	για μήκος λάμας 250 mm	5
11550	για μήκος λάμας 300 mm	5



GET IT NOW

ΠΡΙΟΝΙ ΚΟΥ ΜΕ ΜΕΣΑΙΟ ΔΟΝΤΙ ΚΑΙ ΒΙΔΩΤΗ ΛΑΜΑ

Code	Description	Quantity
10560	code KPG-250J - μήκος λάμας 250 mm	12
10591	λάμα με βίδα	15



ΠΡΙΟΝΙ ΚΟΥ ΚΑJO-300AG

Code	Description	Quantity
03419	μήκος λάμας 300 mm	12



INTER



ΠΡΙΟΝΙ ΚΛΑΔΟΥ

Barcode	Product Name	Quantity
02174	μήκος λάμας 250 mm	10
01479	μήκος λάμας 300 mm	10

GET IT NOW

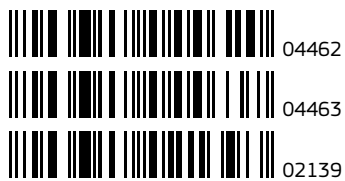

PATCO



ΠΡΙΟΝΙ ΚΛΑΔΟΥ ΙΣΙΟ ΙΝΟΧ

Barcode	Product Name	Quantity
04462	No 0 - μήκος λάμας 250 mm	5
04463	No 1 - μήκος λάμας 300 mm	5
02139	No 2 - μήκος λάμας 350 mm	5

GET IT NOW



PATCO



ΠΡΙΟΝΙ ΚΛΑΔΟΥ ΚΥΡΤΟ

Barcode	Product Name	Quantity
05562	μήκος λάμας 250 mm	5
05563	μήκος λάμας 300 mm	5

GET IT NOW



CORONA



ΠΡΙΟΝΙ ΣΟΥΓΙΑΣ RS4040

Barcode	Product Name	Quantity
02287	μήκος λάμας 165 mm	6



PATCO



ΚΟΝΤΑΡΟΠΡΙΟΝΟ ΚΥΡΤΟ

Barcode	Product Name	Quantity
04465	μήκος λάμας 250 mm	5
04466	μήκος λάμας 300 mm	5

GET IT NOW



KOY



ΚΟΝΤΑΡΟΠΡΙΟΝΟ ΚΟΥ ΜΕ ΜΕΣΑΙΟ ΔΟΝΤΙ

Barcode	Product Name	Quantity
13714	μήκος λάμας 250 mm	5

ΑΛΥΣΟΠΡΙΟΝΑ - ΨΑΛΙΔΕΣ



Το BCL132 είναι μοναδικό στο είδος του, χάρις στο βάρος και στην αποκλειστική του σχεδίαση, λόγω της οποίας μπορεί να χρησιμοποιηθεί σε διάφορες εφαρμογές. Είτε χρησιμοποιείται σε χώρους πρασίνου, σε αμπελώνες ή σε οπωρώνες, το BCL132 κάνει το κλάδεμα παιχνίδι χάρις στο μέγεθός του, την ακρίβειά του και την ποιότητα της ισχύος κοπής.



ΑΛΥΣΟΠΡΙΟΝΟ BCL132 ΕΠΑΝΑΦΟΡΤΙΖΟΜΕΝΗΣ ΜΠΑΤΑΡΙΑΣ

Barcode	Icon	Icon
11582	1200 W	1



09029



11041



06777



10502



10980



10552



10501



11028



ΨΑΛΙΔΑ ΚΛΑΔΟΥ ΑΕΡΟΣ 9210

Barcode	Icon	Icon
09029	ψαλίδα Φ 30 mm	1
06777	λεπίδα ανταλλακτική	1
10980	ελατήριο (1640142)	1
10501	λαστικιάκια σει (20)	1
11041	πύρος (1770106)	1
10502	φλάντζα (1230235)	1
10552	φλάντζα (1230219)	1
11028	αμορτισέρ (1730107)	1



ΨΑΛΙΔΑ ΚΛΑΔΟΥ PX

Barcode	Icon	Icon
03211	code PX-M2 - δυνατότητα κοπής Φ 20 mm	1



03210



08577

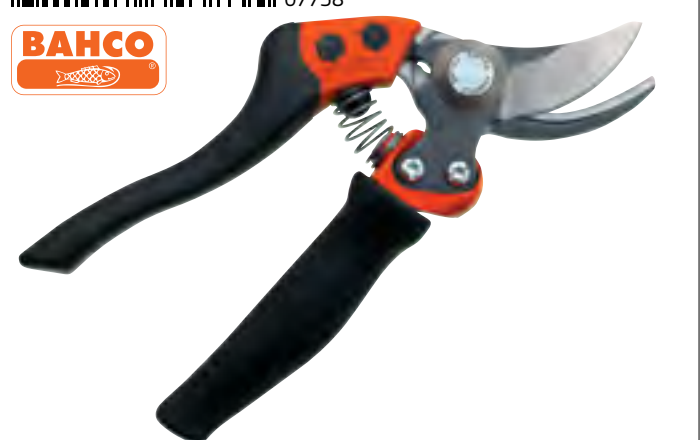

ΨΑΛΙΔΑ ΚΛΑΔΟΥ PXR

Barcode	Icon	Icon
03210	code PXR-M2 - δυνατότητα κοπής Φ 20 mm	2
07738	code PXR-M3 - δυνατότητα κοπής Φ 30 mm	2
08577	code PXR-L2 - δυνατότητα κοπής Φ 20 mm	2

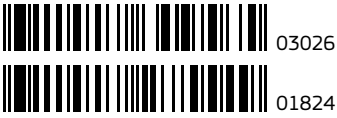

03026

01824



ΨΑΛΙΔΑ ΚΛΑΔΟΥ P110

03026	code P110-20-F - δυνατότητα κοπής Φ 20 mm	2
01824	code P110-23-F - δυνατότητα κοπής Φ 25 mm	2



ΨΑΛΙΔΑ ΚΛΑΔΟΥ P121-23-F

10637	δυνατότητα κοπής Φ 23 mm	2



ΨΑΛΙΔΑ ΚΛΑΔΟΥ PG-12-F

04468	δυνατότητα κοπής Φ 20 mm	2

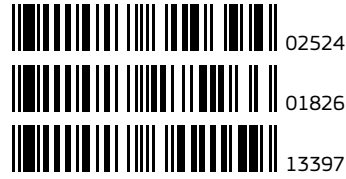

02524

01826

13397



ΨΑΛΙΔΑ ΚΛΑΔΟΥ P3

02524	code P3-20-F - δυνατότητα κοπής Φ 20 mm	2
01826	code P3-23-F - δυνατότητα κοπής Φ 25 mm	2

ΨΑΛΙΔΑ ΚΛΑΔΟΥ P3-23-F

+ ΔΩΡΟ
ΑΝΤΑΛΛΑΚΤΙΚΗ ΛΕΠΙΔΑ

13397	code P3-23-F - δυνατότητα κοπής Φ 25 mm	2



ΨΑΛΙΔΑ ΚΛΑΔΟΥ ΜΕ ΑΜΟΝΙ P138-22-F

12506	δυνατότητα κοπής Φ 25 mm	2



ΨΑΛΙΔΑ ΚΛΑΔΟΥ BR4250

12041	δυνατότητα κοπής Φ 25 mm	3



ΨΑΛΙΔΑ ΚΛΑΔΟΥ ΜΕ ΑΜΟΝΙ

14086	1.107 - δυνατότητα κοπής Φ 22 mm	5
13848	1.104 - δυνατότητα κοπής Φ 25 mm	5



ΨΑΛΙΔΑ ΚΛΑΔΟΥ ΜΕ ΑΜΟΝΙ 3402

09875	δυνατότητα κοπής Φ 28 mm	3



ΨΑΛΙΔΑ ΚΛΑΔΟΥ 3504-23

04228	δυνατότητα κοπής Φ 25 mm	3
00851	ανταλλακτική λεπίδα 3504-H	6

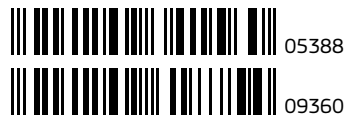

ΨΑΛΙΔΑ ΚΛΑΔΟΥ 3505-23

05388	δυνατότητα κοπής Φ 25 mm	3
09360	ανταλλακτική λεπίδα 3505-H	6

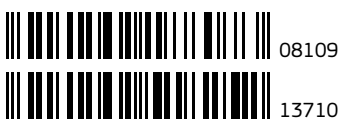

ΨΑΛΙΔΑ ΚΛΑΔΟΥ 23523-21

08109	δυνατότητα κοπής Φ 25 mm	6
13710	ανταλλακτική λεπίδα 3523-21K	6

**HOT
SELLER**



ΨΑΛΙΔΑ ΚΛΑΔΟΥ ΜΑΣΙΦ

03225	δυνατότητα κοπής Φ 25 mm	10
03500	ανταλλακτική λεπίδα	5

BLISTER

**GET IT
NOW**

**NEW
ARRIVAL**



INTER



BLISTER

HOT SELLER

ΨΑΛΙΔΑ ΚΛΑΔΟΥ ΜΑΣΙΦ

ΔΩΡΟ
ΑΝΤΑΛΛΑΚΤΙΚΗ ΛΕΠΙΔΑ
ΚΑΙ ΕΛΑΤΗΡΙΟ

03499	δυνατότητα κοπής Φ 25 mm	6



06131



03500



BLISTER

GET IT NOW

ΨΑΛΙΔΑ ΚΛΑΔΟΥ ΚΟΥΦΙΑ

ΔΩΡΟ
ΑΝΤΑΛΛΑΚΤΙΚΗ ΛΕΠΙΔΑ

06131	δυνατότητα κοπής Φ 25 mm	10
03500	ανταλλακτική λεπίδα	5



ΨΑΛΙΔΑ ΤΡΥΓΟΥ ΚΥΡΤΗ INOX 3623

09763	185 mm	24



ΨΑΛΙΔΑ ΤΡΥΓΟΥ ΚΟΝΤΗ ΚΥΡΤΗ INOX 3625

09764	160 mm	24



ΨΑΛΙΔΑ ΤΡΥΓΟΥ ΜΥΤΕΡΗ INOX 3624

06903	186 mm	24



BELLOTA



ΨΑΛΙΔΑ ΤΡΥΓΟΥ ΜΥΤΕΡΗ ΜΑΚΡΙΑ INOX 3629

		
09765	203 mm	25



BELLOTA



ΨΑΛΙΔΑ ΤΡΥΓΟΥ ΦΑΡΔΙΑ INOX 3628

		
06904	172 mm	24



BELLOTA



ΨΑΛΙΔΑ ΤΡΥΓΟΥ ΦΑΡΔΙΑ INOX 3622

		
09762	185 mm	24



TopMan



ΨΑΛΙΔΑ ΚΛΑΔΟΥ 8020-21 (ΤΥΠΟΥ FELCO)

		
01823	δυνατότητα κοπής Ø 25 mm	6



06061



08983

PRAISE



ΨΑΛΙΔΑ ΚΛΑΔΟΥ ΜΕ ΑΜΟΝΙ ΤΑΪΒΑΝ



		
06061	200 mm	10
08983	ανταλλακτική λεπίδα	10



PATCO



ΨΑΛΙΔΑ ΤΡΥΓΟΥ ΜΥΤΕΡΗ

		
00571	190 mm	10



03229



03224

PRAISE



ΨΑΛΙΔΑ ΤΡΥΓΟΥ ΜΥΤΕΡΗ ΤΑΪΒΑΝ

		
03229	JH8035	12
03224	ανταλλακτικό ελατήριο	50

GET IT NOW



02917



02293

PRAISE





ΨΑΛΙΔΑ ΤΡΥΓΟΥ ΚΟΝΤΗ ΤΑΪΒΑΝ



		
02917	JH711	10
02293	ανταλλακτικό ελατήριο	30





ΨΑΛΙΔΑ ΤΡΥΓΟΥ ΚΟΝΤΗ ΙΣΙΑ ΜΥΤΗ

		
09832	JH803BS	10

ΨΑΛΙΔΑ ΤΡΥΓΟΥ ΚΥΡΤΗ ΜΥΤΗ

		
08982	JH803S-1	10





ΨΑΛΙΔΑ ΤΡΥΓΟΥ ΚΟΝΤΗ ΚΥΡΤΗ ΜΥΤΗ

		
10530	JH803BS-1	10





ΨΑΛΙΔΑ ΤΡΥΓΟΥ ΦΑΡΔΙΑ ΤΑΪΒΑΝ

		
03823	G170	12
09314	ανταλλακτικό ελατήριο	1000







ΨΑΛΙΔΑ ΤΡΥΓΟΥ ΜΥΤΕΡΗ

		
04980	G180	12
09314	ανταλλακτικό ελατήριο	1000
02283	798359 	25
03868	ανταλλακτικό ελατήριο	100



ΨΑΛΙΔΑ ΚΛΑΔΟΥ ΤΑΪΒΑΝ (ΤΥΠΟΥ FELCO)

		
01461	200 mm	5



ΨΑΛΙΔΑ ΚΟΡΥΦΗΣ ΤΑΪΒΑΝ

		
07297	με πρίονι	6



ΨΑΛΙΔΑ ΚΟΡΥΦΗΣ Ρ34-27Α-Ρ

01165	δυνατότητα κοπής Φ 30 mm	2



ΨΑΛΙΔΑ ΚΟΡΥΦΗΣ ΤΑΪΒΑΝ

07298	χωρίς πριόνι	6



09218



09219



ΨΑΛΙΔΑ ΚΛΑΔΟΥ ΜΕ ΠΤΥΣΣΟΜΕΝΟ ΚΟΝΤΑΡΙ 3612

09218	μήκος 1000-1500 mm	1
09219	ανταλλακτική λεπίδα 3612-H	1



ΨΑΛΙΔΑ ΚΛΑΔΟΥ ΜΕ ΠΤΥΣΣΟΜΕΝΟ ΚΟΝΤΑΡΙ ΑΡΤ-230-410

13661	μήκος 2300-4100 mm - Φ 32 mm	2



08142



12260



12782



ΨΑΛΙΔΑ ΚΟΡΜΟΥ ΜΕ ΑΜΟΝΙ 3441-75

08142	μήκος 750 mm - Φ 45 mm	3
12260	ανταλλακτική λεπίδα 3441-HT	1
12782	ανταλλακτικό αμόνι 3441-ΥΤ	1



ΨΑΛΙΔΕΣ ΚΟΡΜΩΝ

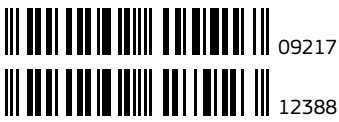

BELLOTA



ΨΑΛΙΔΑ ΚΟΡΜΟΥ ΤΗΛΕΣΚΟΠΙΚΗ 3440-TEL

09217	μήκος 600-900 mm - Φ 35 mm	3
12388	ανταλλακτική λεπίδα 3440-TEL-HT	1



BELLOTA



ΨΑΛΙΔΑ ΚΟΡΜΟΥ ΜΕ ΑΜΟΝΙ ΤΗΛΕΣΚΟΠΙΚΗ 3441-TEL

09216	μήκος 600-900 mm - Φ 45 mm	3
14756	ανταλλακτική λεπίδα 3441-TEL-HT	1
12782	ανταλλακτικό αμόνι 3441-ΥΤ	1



BELLOTA

ΨΑΛΙΔΑ ΚΟΡΜΟΥ 3580

10558



07384	μήκος 600 mm - Φ 50 mm	3
14778	μήκος 750 mm - Φ 50 mm	3
07383	μήκος 900 mm - Φ 50 mm	3
10558	ανταλλακτική λεπίδα 3580-H	1
10446	ανταλλακτική κόντρα λεπίδα 3580-CH	1

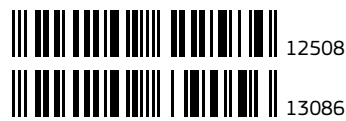

BELLOTA



ΨΑΛΙΔΑ ΚΟΡΜΟΥ POWERCUTx2 3442-75

12508	μήκος 750 mm - Φ 35 mm	3
13086	ανταλλακτική λεπίδα 3442-HT	1

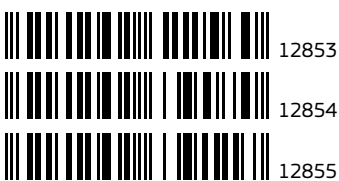

BELLOTA

ΨΑΛΙΔΑ ΚΟΡΜΟΥ ΜΕ ΑΜΟΝΙ POWERCUTx2 3443-75

12853	μήκος 750 mm - Φ 35 mm	3
12854	ανταλλακτική λεπίδα 3443-HT	1
12855	ανταλλακτικό αμόνι 3443-ΥΤ	1



PATCO

GET IT NOW



ΨΑΛΙΔΑ ΚΟΡΜΟΥ

03580	μήκος 650 mm - Φ 40 mm	2

■ NEW ARRIVAL ΝΕΑ ΑΦΙΞΗ ■ HOT SELLER ΚΑΛΥΤΕΡΟ ΣΤΗΝ ΠΩΛΗΣΗ ■ GET IT NOW ΑΞΙΖΕΙ ΝΑ ΑΓΟΡΑΣΕΙΣ ΤΩΡΑ



PATCO



ΨΑΛΙΔΑ ΚΟΡΜΟΥ ΜΕ ΑΜΟΝΙ ΤΗΛΕΣΚΟΠΙΚΗ

		
06401	μήκος 630-883 mm - Φ 30 mm	6

GET IT NOW



PATCO



ΨΑΛΙΔΑ ΚΟΡΜΟΥ ΜΕ ΑΜΟΝΙ ΤΗΛΕΣΚΟΠΙΚΗ

		
03579	μήκος 690-940 mm - Φ 40 mm	2

GET IT NOW



BAHCO



ΨΑΛΙΔΑ ΚΟΡΜΟΥ P114-SL-60

		
05664	μήκος 600 mm - Φ 30 mm	2



BAHCO



ΨΑΛΙΔΑ ΚΟΡΜΟΥ P160-SL-90

		
05096	μήκος 900 mm - Φ 45 mm	1





10668
08705
08706

BAHCO





ΨΑΛΙΔΑ ΚΟΡΜΟΥ ΜΕ ΑΜΟΝΙ P173-SL-85

		
10668	μήκος 850 mm - Φ 45 mm	1
08705	ανταλλακτική λεπίδα R373A	1
08706	ανταλλακτικό αμόνι R376H	1



ΨΑΛΙΔΕΣ ΧΛΟΗΣ - ΓΚΑΖΟΝ



BELLOTA



ΨΑΛΙΔΑ ΧΛΟΗΣ 3461-C ΜΕ ΚΥΜΑΤΟΕΙΔΗ ΛΑΜΑ

09931 μήκος λάμας 230 mm 3



BELLOTA



ΨΑΛΙΔΑ ΧΛΟΗΣ 23587 ΜΕ ΚΥΜΑΤΟΕΙΔΗ ΛΑΜΑ

06938 μήκος λάμας 185 mm 6



PATCO

GET IT NOW



ΨΑΛΙΔΑ ΧΛΟΗΣ

02065 μήκος λάμας 250 mm 6



ΨΑΛΙΔΑ ΧΛΟΗΣ ΤΑΪΒΑΝ ΜΕ ΚΥΜΑΤΟΕΙΔΗ ΛΑΜΑ

02509 μήκος λάμας 210 mm 12



BELLOTA

BLISTER



ΨΑΛΙΔΑ ΓΚΑΖΟΝ 3555 (3 ΘΕΣΕΩΝ)

05289 μήκος 350 mm 6



BAHCO

BLISTER



ΨΑΛΙΔΑ ΓΚΑΖΟΝ GS-76 (3 ΘΕΣΕΩΝ)

03047 μήκος 355 mm 8

■ NEW ARRIVAL ΝΕΑ ΑΦΙΞΗ ■ HOT SELLER ΚΑΛΥΤΕΡΟ ΣΤΗΝ ΠΩΛΗΣΗ ■ GET IT NOW ΑΞΙΖΕΙ ΝΑ ΑΓΟΡΑΣΕΙΣ ΤΩΡΑ



ΛΕΠΙΔΙΑ ΨΑΛΙΔΩΝ

Barcode	Part Name	Quantity
05229	R201P για P1-P2/22	1
03993	R211P για PX, PXR, P1-P2/20 (No 2)	1
06590	R116V για P16	1
06883	R160A για P160	1
04015	R16V για P116-SL, PSL2	1
06086	R172A για P172	1
09758	R372H αμόνι για P172-(SL)	1
03832	R223P για P138/22	1
03450	R114PG για P108-P110/20	1
00868	R124PG για P108-P110/23	1
01890	R112PG για P3-P5/20	1
01891	R122PG για P3-P5/23	1
06552	R137E για P34-37	1
08249	R500P για PX, PXR (№3)	1
10682	R123P για P121-23-F	1
11618	R380A για P172-(SL)	1
13735	R224P για P39-22	1



ΕΛΑΤΗΡΙΑ ΨΑΛΙΔΩΝ ΚΛΑΔΟΥ

Barcode	Part Name	Quantity
01528	R1068 για P3, P5, P108, P110	14
04613	R1069P για P1, P2, P6, P7	12
03678	R1075 για P123, P127, P128, P129	50
08610	R906P για PX, PXR (M)	1



ΣΕΤ 2 ΤΜΧ ΠΙΑΣΤΡΕΣ ΨΑΛΙΔΩΝ ΚΛΑΔΟΥ R474P

Barcode	Part Name	Quantity
03011	για P110-20/23	5



ΣΕΤ ΑΣΦΑΛΕΙΕΣ ΨΑΛΙΔΩΝ ΚΛΑΔΟΥ

Barcode	Part Name	Quantity
03245	R341P για P3-20/23	1
10152	R480P για P5-20/23	1



ΨΑΛΙΔΩΝ ΑΝΤΑΛΛΑΚΤΙΚΑ

08258
11098

ΕΛΑΤΗΡΙΑ ΨΑΛΙΔΩΝ ΚΟΡΥΦΗΣ

08258	R427AE για P34-27A-F	1
11098	R437E για P34-37	1

01656

ΕΛΑΤΗΡΙΑ ΨΑΛΙΔΩΝ ΤΡΥΓΟΥ

01656		50
-------	--	----

11048
10444

ΕΛΑΤΗΡΙΑ ΨΑΛΙΔΩΝ

11048	3512MA για 3512-21/22	1
10444	για τρύγου inox	12

04484

ΕΛΑΤΗΡΙΑ ΨΑΛΙΔΩΝ

για κούφια & μασίφ

04484		20
-------	--	----

01454
04233

ΣΚΟΥΛΗΚΙΑ ΨΑΛΙΔΩΝ

01454	μήκος 5 cm	20
04233	μήκος 7 cm	20

06546
06547
13024
08672

ΛΑΣΤΙΧΑΚΙΑ ΨΑΛΙΔΩΝ

06546	R440V	1
06547	R515VS	1
13024	R903P για PX, PXR, P1, P2	1
08672	3578-A	6

14094

ΛΑΣΤΙΧΑΚΙΑ ΨΑΛΙΔΑΣ ΚΟΡΜΟΥ 3578-TELA

14094	σετ 2 τμχ	1
-------	-----------	---

08611
05033
03244
01739

ΒΙΔΕΣ ΨΑΛΙΔΩΝ ΚΛΑΔΟΥ

























08611	R900P για PX, PXR	1
05033	R239P για P1-20/22, P2-20/22	2
03244	R142P για P3, P5, P110, P34-27A	2
01739		10

08366
08365
11963
10445

ΒΙΔΕΣ ΨΑΛΙΔΩΝ ΚΟΡΜΟΥ



08366	R660V για P160	1
08365	R144PV κεντρική P160	1
11963	R772V για P172-SL	1
10445	3578-BT	6

■ NEW ARRIVAL ΝΕΑ ΑΦΙΞΗ ■ HOT SELLER ΚΑΛΥΤΕΡΟ ΣΤΗΝ ΠΩΛΗΣΗ ■ GET IT NOW ΑΞΙΖΕΙ ΝΑ ΑΓΟΡΑΣΕΙΣ ΤΩΡΑ



	04160		03082
	08287		06113
	03835		01909
	13009		02207
	05313		12371
	05314		05953
	01623		06269
	03080		03076
	03079		07933
	05315		08133
	00139		12387
	03081		03624



ΕΚΘΕΤΗΡΙΟ ΞΥΛΩΝ 8970-V

		
03624	760x400x530 mm (AxBxΓ)	1



ΞΥΛΑ

		
04160	Φ1 30 mm / Φ2 26 mm - code M0-900 SB - για σκαλιστήρι	12
08287	Φ1 32 mm / Φ2 30 mm - code M1-600 SB - για σκαλιστήρι	12
03835	Φ1 32 mm / Φ2 30 mm - code M1-900 SB - για σκαλιστήρι	12
13009	Φ1 32 mm / Φ2 30 mm - code M1-1200 SB - για σκαλιστήρι	12
05313	Φ1 35 mm / Φ2 32 mm - code M2-900 SB - για σκαλιστήρι	12
05314	Φ1 37,5 mm / Φ2 34 mm - code M3-1200 SB - για σκαλιστήρι	12
01623	Φ1 41 mm / Φ2 37 mm - code M4-1200 SB - για αξίνα	12
03080	Φ1 43 mm / Φ2 39 mm - code M5-1200 SB - για αξίνα	12
03079	Φ1 46 mm / Φ2 42 mm - code M6-900 SB - για κασμά	12
05315	Φ1 46 mm / Φ2 42 mm - code M6-1200 SB - για τσεκουροστενή	12
00139	code M 5556-2R SB - ίσια για φτυάρια	12
03081	code M 5556-2C SB - κυρτά για φτυάρια	12
03082	Φ1 36 mm / Φ2 32 mm - code M 5938 SB - για σκεπάρνι	50
06113	Φ1 18,5 mm / Φ2 28 mm - code M 952 SB - 1,20 m για τσουγκράνα	12
01909	Φ1 15 mm / Φ2 28 mm - code M 952L SB - 1,50 m για τσουγκράνα	12
02207	code M 5308-A - για βαριοπούλα	12
12371	code M 5931-ON - για κασμαδάκι	12
05953	code M 8017-A - για κασμαδάκι (οβάλ)	12
06269	code M 5460-3 - για τσεκουροβαριά (οβάλ)	6
03076	Φ1 23,5 mm / Φ2 38 mm - code M 5604 A (Δ) SB - για πατητή πηρούνα D	12
07933	Φ1 23,5 mm / Φ2 38 mm - code M 5604 M (T) SB - για πατητή πηρούνα T	12
08133	Φ1 28 mm / Φ2 37 mm - code M 901 LR 120 SB - ίσιο για πηρούνα	12
12387	Φ1 39 mm / Φ2 33 mm - code M 5312 - για σφυρί κτιστών	12

-  04354
-  04353
-  04352
-  05278
-  04351
-  04350
-  06368



ΣΤΕΙΛΙΑΡΙΑ FIBERGLASS

		
04354	Φ 34 mm - 40GR38G - για σκεπάρνι	5
04353	Φ 46 mm - 4091/PT - για κασμά	5
04352	Φ 26 mm - 150RACONP - για τσουγκράνα	5
05278	4091MG - οβάλ για τσεκούρι	5
04351	1130VP - για φτυάρι ίσιο	5
04350	1130BP - για φτυάρι κυρτό	5
06368	Φ 40 mm - 40120ZP - για αξίνα	5

05919
07853

ΞΥΛΑ (ΧΟΝΤΡΑ) ΓΙΑ ΚΟΝΤΑΡΟΠΡΙΟΝΑ

05919	Φ 28 mm - μήκος 2,0 m	20
07853	Φ 29 mm - μήκος 2,5 m	20

00946
00947

ΞΥΛΑ ΜΠΑΤΑΝΟΒΟΥΡΤΣΑΣ

00946	Φ 24,5 mm - μήκος 2,0 m	20
00947	Φ 24,5 mm - μήκος 2,5 m	20

ΞΥΛΑ ΑΞΙΝΑΣ - ΟΞΥΑ

00929	Φ 42 mm - μήκος 1,2 m	20

ΞΥΛΑ ΤΣΟΥΓΚΡΑΝΑΣ - ΟΞΥΑ

00934	Φ 30 mm - μήκος 1,4 m	20

ΞΥΛΑ ΛΑΣΠΗΣ - ΟΞΥΑ

00936	μήκος 1,4 m	10

ΞΥΛΑ ΦΤΥΑΡΙΩΝ ΜΟΝΟΚΥΡΤΑ - ΟΞΥΑ

00930	μήκος 1,2 m	20

ΞΥΛΑ ΦΤΥΑΡΙΩΝ ΔΙΠΛΟΚΥΡΤΑ - ΟΞΥΑ

00931	μήκος 1,2 m	20

GET IT NOW

ΞΥΛΑ ΣΚΕΡΠΑΝΙΩΝ - ΟΞΥΑ

00943	Φ 34,5 mm - μήκος 0,4 m	50

ΞΥΛΑ ΚΑΣΜΑ - ΟΞΥΑ

00933	Φ 45 mm - μήκος 0,9 m	20

ΞΥΛΑ ΓΙΑ ΤΣΕΚΟΥΡΑΚΙΑ ΚΛΑΔΟΥ ΠΛΑΚΕ

03655	μήκος 0,42 m - με σφήνα	5



04177
00944
07335
08862

ΞΥΛΑ ΤΣΕΚΟΥΡΙΩΝ ΚΩΝΙΚΑ (ΛΙΑΤΑ)

04177	No 00 - μήκος 0,7 m	20
00944	No 1 - μήκος 0,9 m	20
07335	No 2 - μήκος 0,9 m	20
08862	No 3 - μήκος 0,9 m	10



ΞΥΛΑ ΓΙΑ ΤΣΕΚΟΥΡΑΚΙΑ ΚΛΑΔΟΥ (ΛΙΑΤΑ)

09128	No 000 - μήκος 0,45 m	10

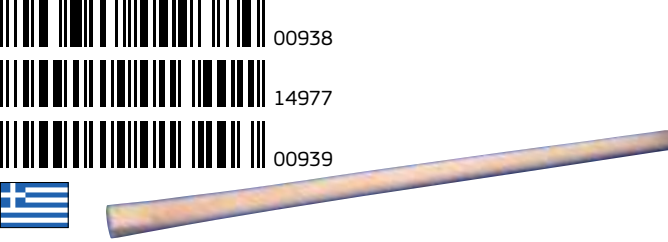

00938
14977
00939

ΞΥΛΑ ΣΚΑΛΙΣΤΗΡΙΩΝ

00938	Φ 32 mm - μήκος 0,7 m	40
14977	Φ 32,5 mm - μήκος 1,0 m	20
00939	Φ 32,5 mm - μήκος 1,1 m	20



ΞΥΛΑ ΚΟΣΑΣ

00935	μήκος 1,8 m	10



ΞΥΛΑ ΣΚΟΥΠΑΣ ΧΩΡΙΣ ΣΠΕΙΡΩΜΑ

04174	Φ 22 mm - μήκος 1,2 m	10



HOT SELLER

ΞΥΛΑ ΣΚΟΥΠΑΣ ΜΕ ΣΠΕΙΡΩΜΑ

08062	Φ 22 mm - μήκος 1,2 m	25



**ΑΝΕΜΗ
ΜΕΤΑΛΛΙΚΗ
ΓΙΑ ΛΑΣΤΙΧΟ AG 210**

03776	Φ 1/2" x 50 m	1



ΑΝΕΜΗ ΓΙΑ ΛΑΣΤΙΧΟ DROP 60

02611	Φ 1/2" x 60 m	1



**ΚΑΡΟΥΛΙ ΤΟΙΧΟΥ
ΜΕΤΑΛΛΙΚΟ ΓΙΑ ΛΑΣΤΙΧΟ AG 131**

03771	Φ 1/2" x 50 m	1



13759



13760



ΣΕΛΑ ΜΕΤΑΛΛΙΚΗ ΚΡΕΜΑΣΤΗ

13759	λευκή	6
13760	πράσινη	6



08531



08532



08533



ΣΕΛΑ ΜΕΤΑΛΛΙΚΗ ΤΟΙΧΟΥ

08531	γκρι	6
08532	λευκή	6
08533	πράσινη	6

**HOT
SELLER**
**GET IT
NOW**



ΣΕΛΑ ΠΛΑΣΤΙΚΗ ΤΟΙΧΟΥ



03772



code 110 - πορτοκαλί



7



ΣΕΛΑ ΠΛΑΣΤΙΚΗ ΤΟΙΧΟΥ



00517



code 20760 - πράσινη



6



ΣΕΛΑ ΜΕΤΑΛΛΙΚΗ ΤΟΙΧΟΥ ΒΑΡΕΩΣ ΤΥΠΟΥ



04956



γαλβανιζέ



5



06042



02626



06044



06043



GET IT NOW

ΣΕΛΑ ΠΛΑΣΤΙΚΗ ΤΟΙΧΟΥ



06042



γκρι



10

02626

λευκή

10

06044

μαύρη

10

06043

πράσινη

10



09339



09340



09341



09342



09339



09340



09341



09342

ΣΕΛΑ ΔΙΑΚΟΣΜΗΤΙΚΗ ΤΟΙΧΟΥ



09339



code 775133 - πάπια διπλή



4

09340

code 775132 - πάπια μονή

4

09341

code 775131 - κόκκορας μεγάλος

4

09342

code 775128 - κόκκορας μικρός

4

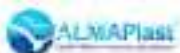

NEW
ARRIVAL

ΛΑΣΤΙΧΟ ΠΟΤΙΣΜΑΤΟΣ CRICKET

Barcode	Icon	Product Code	Dimensions	Quantity
07744	📦	07744	Φ 1/2" x 15m	1
07745	📦	07745	Φ 1/2" x 25m	1
14950	📦	14950	Φ 1/2" x 50m	1
07746	📦	07746	Φ 5/8" x 15m	1
07747	📦	07747	Φ 5/8" x 25m	1
07748	📦	07748	Φ 5/8" x 50m	1
07749	📦	07749	Φ 3/4" x 25m	1
07750	📦	07750	Φ 3/4" x 50m	1



ΛΑΣΤΙΧΟ ΠΟΤΙΣΜΑΤΟΣ VERSUS

Barcode	Icon	Product Code	Dimensions	Quantity
12143	📦	12143	Φ 1/2" x 15 m	1
12144	📦	12144	Φ 1/2" x 25 m	1
12145	📦	12145	Φ 5/8" x 15 m	1
12146	📦	12146	Φ 5/8" x 25 m	1
12147	📦	12147	Φ 5/8" x 50 m	1
12148	📦	12148	Φ 3/4" x 25 m	1
12149	📦	12149	Φ 3/4" x 50 m	1

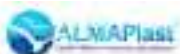

GET IT NOW

ΛΑΣΤΙΧΟ ΠΕΤΡΟΓΚΑΖ 50 m

Barcode	Icon	Product Code	Dimensions	Quantity
10382	📦	10382	Φ 8 x 13 mm	1



ΛΑΣΤΙΧΟ ΟΥΥΓΟΝΟΥ 50 m

Barcode	Icon	Product Code	Dimensions	Quantity
10381	📦	10381	Φ 8 x 15 mm	1

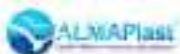

ΛΑΣΤΙΧΟ ΕΙΣΑΓΩΓΗΣ ΠΛΥΝΤΗΡΙΟΥ

Barcode	Icon	Product Code	Dimensions	Quantity
10378	📦	10378	μήκος 1,5 m	5



ΛΑΣΤΙΧΟ ΕΞΑΓΩΓΗΣ ΠΛΥΝΤΗΡΙΟΥ

Barcode	Icon	Product Code	Dimensions	Quantity
10379	📦	10379	μήκος 2 m	5
10380	📦	10380	μήκος 3 m	5



M Martin
craft

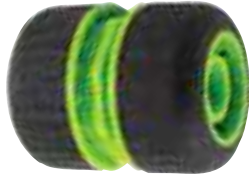

BLISTER

ΣΥΝΔΕΣΜΟΣ ΛΑΣΤΙΧΩΝ

10363	3/4" - code 20622	36



M Martin
craft



BLISTER

ΡΑΚΟΡ ΠΛΑΣΤΙΚΟ ΑΡΣΕΝΙΚΟ

10358	3/4" - code 20640	24



11063



07764

G.E.



ΕΚΘΕΤΗΡΙΟ ΤΟΙΧΟΥ LINEAR 3200.0030

11063	99,5 x 46,5 x 201	1

ΕΚΘΕΤΗΡΙΟ ΚΟΛΩΝΑ SUPER PLANET 3200.0041

07764	40 x 165,5	1



00777



02915



08362



00778



00133

G.E.



ΣΥΝΔΕΣΜΟΣ ΛΑΣΤΙΧΩΝ ΣΕ ΚΟΥΤΙ

00777	1/2" - 5/8" - code 8000.3439	25
02915	3/4" - code 8000.3437	25
08362	1" - code 8000.3442	20

ΣΥΝΔΕΣΜΟΣ ΛΑΣΤΙΧΩΝ

BLISTER

00778	1/2" - 5/8" - code 8000.5439	10
00133	3/4" - code 8000.5437	10



02912



00339



02913



00639

G.E.



ΤΑΧΥΣΥΝΔΕΣΜΟΣ ΣΕ ΚΟΥΤΙ

02912	1/2" - 5/8" - code 8000.3020	25
00339	3/4" - code 8000.3023	25

ΤΑΧΥΣΥΝΔΕΣΜΟΣ

BLISTER

02913	1/2" - 5/8" - code 8000.5020	10
00639	3/4" - code 8000.5023	10

HOT
SELLER



ΣΥΝΔΕΣΜΟΣ ΛΑΣΤΙΧΩΝ ΣΥΣΤΟΛΙΚΟΣ

05620	1/2" - 5/8" - 3/4" - code 8000.3443	25



ΤΑΧΥΣΥΝΔΕΣΜΟΣ ΓΕΝΙΚΗΣ ΧΡΗΣΗΣ

07728	1/2" - 5/8" - 3/4" - code 8000.3027	25



07721



07722

ΤΑΧΥΣΥΝΔΕΣΜΟΣ ΜΕ ΔΙΑΚΟΠΤΗ

07721	1/2" - 5/8" - code 8000.3024	25
07722	3/4" - code 8004.3029	30



ΡΑΚΟΡ ΠΛΑΣΤΙΚΟ ΑΡΣΕΝΙΚΟ ΣΕ ΚΟΥΤΙ

06124	3/4" - code 8000.3429	25



01398



04157

ΡΑΚΟΡ ΠΛΑΣΤΙΚΟ ΘΗΛΥΚΟ ΣΕ ΚΟΥΤΙ

01398	3/4" - code 8000.3433	25
04157	1" - code 8000.3432	25

**HOT
SELLER**



ΡΑΚΟΡ ΠΛΑΣΤΙΚΟ ΘΗΛΥΚΟ

01877	3/4" - code 8000.5433	10



ΡΑΚΟΡ ΠΛΑΣΤΙΚΟ ΘΗΛΥΚΟ ΣΕ ΚΟΥΤΙ

01404 3/4" - Νο 204 50



ΡΑΚΟΡ ΣΥΝΔΕΣΜΟΣ ΘΗΛΥΚΟ ΣΕ ΚΟΥΤΙ Νο 203

01104 ρακόρ 3/4" - σύνδεσμος 1/2" - 5/8" 50

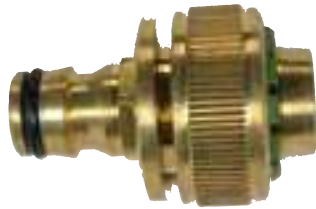

ΤΑΧΥΣΥΝΔΕΣΜΟΣ 5057 ΟΡΕΙΧΑΛΚΙΝΟΣ ΑΙΦΑ

06417 3/4" 25



ΣΥΝΔΕΣΜΟΣ ΔΙΠΛΟΣ ΤΑΧΥΣΥΝΔΕΣΜΩΝ

00815 code 8000.3450 25



ΣΥΝΔΕΣΜΟΣ ΛΑΣΤΙΧΩΝ ΔΙΠΛΟΣ

01842 code 8000.5073 8



ΣΥΝΔΕΣΜΟΣ ΛΑΣΤΙΧΩΝ 3 ΕΞΟΔΩΝ ΜΕ ΔΙΑΚΟΠΤΗ

12807 πλαστικός - code 8000.5072 4



ΠΟΤΙΣΤΙΚΟ JET ΚΥΚΛΙΚΟ ΜΕ ΒΑΣΗ ΠΕΤΑΛΟΥΔΑΣ

07724 code 8000.5667 2



**ΠΟΤΙΣΤΙΚΟ ROTAX
ΣΠΑΘΑ ΔΙΠΛΟ**



12811



code 8000.5633



8



ΠΟΤΙΣΤΙΚΟ ΒΕΝΤΑΛΙΑ ΜΕΤΑΛΛΙΚΗ ΦΛΟΓΕΡΑ



00782



code 8000.5666



6



**ΠΟΤΙΣΤΙΚΟ SPLIT 1
ΣΠΑΘΑ & ΜΠΕΚ ΠΛΑΣΤΙΚΑ**



12812



code 8000.5624



8



ΠΟΤΙΣΤΙΚΟ ΒΕΝΤΑΛΙΑ ΠΛΑΣΤΙΚΗ ΦΛΟΓΕΡΑ



01468



code 8000.5669



6



**ΠΟΤΙΣΤΙΚΟ JET
ΣΠΑΘΑ ΚΥΚΛΙΚΟ**



07725



code 8000.5670



6



01129



01131



01132



01129



01131



01132

ΠΟΤΙΣΤΙΚΑ ΒΑΣΗΣ ΜΕΤΑΛΛΙΚΑ ΤΑΪΒΑΝ

Barcode	Code	Quantity
01129	code 800	5
01131	code 803	5
01132	code 804	5



ΠΟΤΙΣΤΙΚΟ ΒΑΣΗΣ ΜΕΤΑΛΛΙΚΟ ΤΑΪΒΑΝ

Barcode	Code	Quantity
06098	code 203	6

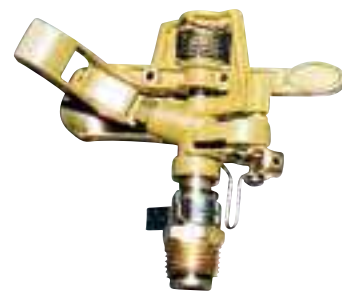

ΜΠΕΚ ΜΕΤΑΛΛΙΚΟ ΡΥΘΜΙΖΟΜΕΝΟ ΤΑΪΒΑΝ

Barcode	Code	Quantity
01125	code 603	12



ΣΠΑΘΑ ΜΕΤΑΛΛΙΚΗ ΓΙΑ ΜΠΕΚ ΤΑΪΒΑΝ

Barcode	Code	Quantity
02134	code 900	10



ΠΟΤΙΣΤΙΚΟ ΜΕ ΣΠΑΘΑ & ΜΠΕΚ ΜΕΤΑΛΛΙΚΑ



06412



Ταϊβάν



12



ΠΟΤΙΣΤΙΚΟ ΜΕ ΣΠΑΘΑ ΜΕΤΑΛΛΙΚΗ & ΜΠΕΚ ΠΛΑΣΤΙΚΟ



02764



Ταϊβάν



12



ΠΟΤΙΣΤΙΚΟ ΜΕ ΣΠΑΘΑ & ΜΠΕΚ ΠΛΑΣΤΙΚΑ



02765



Ταϊβάν



12



01126



01127



01128



01128

01127

01126

ΠΟΤΙΣΤΙΚΟ ΜΠΕΚ ΜΕ ΣΠΑΘΑ ΜΕΤΑΛΛΙΚΗ



01126



code 902



5

01127

code 903

5

01128

code 904

5



ΥΔΡΟΡΥΘΜΙΣΤΗΣ ΠΛΑΣΤΙΚΟΣ



02242



code 8000.3405



25



ΥΔΡΟΡΥΘΜΙΣΤΗΣ ΠΛΑΣΤΙΚΟΣ



10999



8004.3407



20



ΔΙΑΣΚΟΡΠΙΣΤΗΣ ΓΙΑ ΤΑΧΥΣΥΝΔΕΣΜΟ

12810 code 8000.5430 10



ΔΙΑΣΚΟΡΠΙΣΤΗΣ ΝΕΡΟΥ

00346 Ταιβάν 12



ΔΙΑΣΚΟΡΠΙΣΤΗΣ ΝΕΡΟΥ ΜΕ ΠΡΟΕΚΤΑΣΗ & ΔΙΑΚΟΠΤΗ

02200 code 705 2



ΔΙΑΣΚΟΡΠΙΣΤΗΣ ΝΕΡΟΥ ΜΕ ΔΙΑΚΟΠΤΗ

03775 code 700 2



ΠΙΣΤΟΛΙ ΝΕΡΟΥ ΠΛΑΣΤΙΚΟ

02240 8000.6903 6



ΠΙΣΤΟΛΙ ΝΕΡΟΥ ΜΕΤΑΛΛΙΚΟ

12808 code 8000.5547 8



ΠΙΣΤΟΛΙ ΝΕΡΟΥ 5 ΘΕΣΕΩΝ ΠΛΑΣΤΙΚΟ

12809 code 8000.6905 6



ΠΙΣΤΟΛΙ ΝΕΡΟΥ ΕΛΑΦΡΟΥ ΤΥΠΟΥ

09407 Πλαστικό 16



ΠΙΣΤΟΛΙ ΝΕΡΟΥ ΒΑΡΕΩΣ ΤΥΠΟΥ ΤΑΪΒΑΝ

01529 Πλαστικό 12



ΠΡΟΓΡΑΜΜΑΤΙΣΤΗΣ ΝΕΡΟΥ

06252	code 8000.6018	2



ΒΟΥΡΤΣΑ ΠΕΡΙΣΤΡΕΦΟΜΕΝΗ ΟΧΗΜΑΤΩΝ

07726	code 8000.5175	6



ΠΡΟΓΡΑΜΜΑΤΙΣΤΗΣ ΝΕΡΟΥ

12025	16 Προγραμμάτων	2



04827



02568



ΒΟΥΡΤΣΑ ΠΛΥΣΙΜΑΤΟΣ ΟΧΗΜΑΤΩΝ

04827	Σκέτη 8000.5218	4
02568	Σετ με ταχυσύνδεσμο 8000.5224	4

	04442		03666
	04759		04762
	00645		05139
	04760		04763
	05245		05576
	04761		04764

ΜΙΚΑΛΟΡ

ΣΦΙΓΚΤΗΡΕΣ ASFA-S

04442	90-110	25
04759	100-120	25
00645	110-130	25
04760	120-140	25
05245	130-150	25
04761	140-160	25

03666	150-170	25
04762	160-180	25
05139	170-190	10
04763	180-200	10
05576	190-210	10
04764	200-220	10



	04768		04774		04780		04786
	04769		04775		04781		04787
	04770		04776		04782		04788
	04771		04777		04783		04789
	04772		04778		04784		04790
	04773		04779		04785		

ΜΙΚΑΛΟΡ

ΣΦΙΓΚΤΗΡΕΣ SUPER

04768	17-19	50
04769	20-22	50
04770	23-25	50
04771	26-28	50
04772	29-31	50
04773	32-35	50
04774	36-39	50
04775	40-43	50
04776	44-47	50
04777	48-51	50
04778	52-55	25
04779	56-59	25
04780	60-63	25
04781	64-67	25
04782	68-73	25
04783	74-79	25
04784	80-85	25

04785	86-91	25
04786	92-97	25
04787	98-103	25
04788	104-112	25
04789	113-121	25
04790	122-130	25





GET IT NOW

	02289		02009
	03861		04755
	00822		04756
	00823		04757
	00824		07118
	00825		04758

MIKALOR

ΣΦΙΓΚΤΗΡΕΣ ASFA-L

02289	8-12	200
03861	8-16	200
00822	12-22	200
00823	16-27	200
00824	20-32	200
00825	25-40	100

02009	32-50	100
04755	40-60	100
04756	50-70	100
04757	60-80	100
07118	70-90	50
04758	80-100	50



	04765		13655
	04766		13656
	04767		13657

	13658
	13659
	13660

MIKALOR

ΣΦΙΓΚΤΗΡΕΣ ASFA-L W4 (INOX)

04765	8-16	200
04766	12-22	200
04767	16-27	200
13655	20-32	200
13656	25-40	100

13657	32-50	100
13658	40-60	100
13659	50-70	100
13660	60-80	100

	02493		02729
	03018		07731

MIKALOR

ΣΦΙΓΚΤΗΡΕΣ NORMAL

02493	9,5-10	100
03018	10-11	100
02729	12-13	100
07731	14-15	100





MIKALOR



ΕΚΘΕΤΗΡΙΟ ΣΦΙΓΚΤΗΡΩΝ ΕΛΑΦΡΟΥ ΤΥΠΟΥ

Barcode	Icon	Unit
04791	Τοίχου	1



ΣΦΙΓΚΤΗΡΕΣ ΛΑΣΤΙΧΩΝ ΜΕ ΠΕΤΑΛΟΥΔΑ ΠΛΑΣΤΙΚΗ

Barcode	Icon	Unit
05830	8-13mm (3/8")	200
05831	10-16mm (1/2")	200
05832	13-19mm (5/8")	200
05833	16-23mm (3/4")	200
05094	22-30mm (1")	200



ΑΚΡΟΦΥΣΙΑ ΤΥΠΟΥ "ΚΑΡΦΙ" & "ΔΙΠΛΟ ΚΑΡΦΙ"



ΑΚΡΟΦΥΣΙΟ ΤΥΠΟΥ "ΒΕΝΤΑΛΙΑ"

ΑΚΡΟΦΥΣΙΟ ΤΥΠΟΥ "ΟΜΠΡΕΛΑ"

ΨΕΚΑΣΤΗΡΑΣ ΠΛΑΤΗΣ ΠΛΑΣΤΙΚΟΣ

Barcode	Icon	Unit
09152	16Lt	1

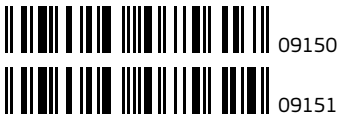

09150



09151



GET IT NOW



ΡΥΘΜΙΖΟΜΕΝΟ ΑΚΡΟΦΥΣΙΟ



ΜΟΝΟΣ ΙΜΑΝΤΑΣ ΑΝΑΡΤΗΣΗΣ

ΨΕΚΑΣΤΗΡΕΣ ΠΡΟΠΙΕΣΗΣ

Barcode	Volume	Quantity
09150	5,0Lt	1
09151	8,0Lt	1

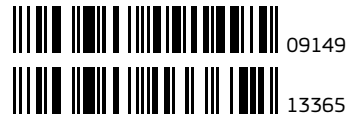

09149



13365



GET IT NOW



ΡΥΘΜΙΖΟΜΕΝΟ ΑΚΡΟΦΥΣΙΟ



ΑΣΦΑΛΕΙΑ ΨΕΚΑΣΜΟΥ ΣΤΗ ΧΕΙΡΟΛΑΒΗ

ΨΕΚΑΣΤΗΡΕΣ ΠΡΟΠΙΕΣΗΣ

Barcode	Volume	Quantity
09149	1,5Lt	1
13365	2,0Lt	1

ΨΕΚΑΣΤΗΡΕΣ





ΨΕΚΑΣΤΗΡΑΚΙ

		
04207	1,0Lt	23

GET IT NOW





ΨΕΚΑΣΤΗΡΑΚΙ

		
09148	1,0Lt	10





15355
14779
11052





14779
11052

ΨΕΚΑΣΤΗΡΕΣ ΠΡΟΠΙΕΣΗΣ

		
15355	1,0Lt	6
14779	2,0Lt	6
11052	10Lt	1

NEW ARRIVAL





03021
03023
02534





03021
02534
03023

ΨΕΚΑΣΤΗΡΕΣ ΠΡΟΠΙΕΣΗΣ ΘΕΜΑ - GAMMA

		
03021	2,0Lt	9
03023	5,0Lt	1
02534	10Lt	1

GET IT NOW



ΨΕΚΑΣΤΗΡΕΣ



02885



02210



03096



ΨΕΚΑΣΤΗΡΕΣ ΠΛΑΤΗΣ ΜΙΥΡΑ ΠΛΑΣΤΙΚΟΙ

02885	12Lt	1
02210	16Lt	1
03096	22Lt	1



11180



11053



ΨΕΚΑΣΤΗΡΑΣ ΠΛΑΤΗΣ ΠΛΑΣΤΙΚΟΣ 3710

11180	12Lt	1
11053	16Lt	1



00794



01956



ΨΕΚΑΣΤΗΡΑΣ ΠΛΑΤΗΣ ΟΡΕΙΧΑΛΚΙΝΟΣ

00794	Ορειχάλκινο καπάκι	1
01956	Πλαστικό καπάκι	1

■ NEW ARRIVAL ΝΕΑ ΑΦΙΞΗ ■ HOT SELLER ΚΑΛΥΤΕΡΟ ΣΤΗΝ ΠΩΛΗΣΗ ■ GET IT NOW ΑΞΙΖΕΙ ΝΑ ΑΓΟΡΑΣΕΙΣ ΤΩΡΑ

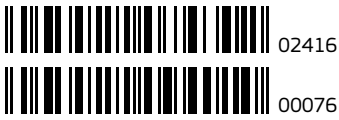

ΑΝΤΑΛΛΑΚΤΙΚΑ ΣΕΤ ΨΕΚΑΣΤΗΡΩΝ ΠΡΟΠΙΕΣΗΣ

Barcode	Icon	Volume	Quantity
02416		2,0 Lt (1500201)	1
00076		5,0 & 10Lt (4503C)	1



02416



00076



ΑΝΤΑΛΛΑΚΤΙΚΑ ΕΜΒΟΛΟΥ ΟΡΕΙΧΑΛΚΙΝΟΥ ΨΕΚΑΣΤΗΡΑ ΠΛΑΤΗΣ

Barcode	Icon	Quantity
00222		3508BOX 1



ΑΝΤΑΛΛΑΚΤΙΚΑ ΕΜΒΟΛΟΥ ΠΛΑΣΤΙΚΟΥ ΨΕΚΑΣΤΗΡΑ ΠΛΑΤΗΣ

Barcode	Icon	Quantity
08273		3507BOX 1



ΕΜΒΟΛΟ ΨΕΚΑΣΤΗΡΩΝ ΠΡΟΠΙΕΣΗΣ 5Lt & 10Lt

Barcode	Icon	Quantity
03739		για 4506C 1



ΕΜΒΟΛΟ ΨΕΚΑΣΤΗΡΩΝ ΠΛΑΤΗΣ

Barcode	Icon	Quantity
03740		για MIURA 1
04210		για SONIA 1

03740



04210

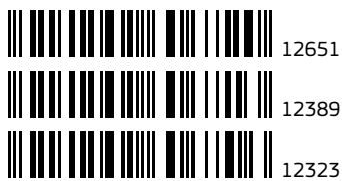

ΕΜΒΟΛΑ ΨΕΚΑΣΤΗΡΩΝ ΠΡΟΠΙΕΣΗΣ BELLOTA

Barcode	Icon	Volume	Unit
12651		10Lt - (R3710-8)	1
12389		12Lt - (R3710-7)	1
12323		16Lt - (R3710-6)	1



ΑΝΤΑΛΛΑΚΤΙΚΑ ΣΕΤ ΨΕΚΑΣΤΗΡΩΝ

Barcode	Icon	Volume	Unit
12391		10Lt (R3710-10)	1
12390		12&16Lt (R3710-5)	1



ΑΝΤΑΛΛΑΚΤΙΚΟ ΛΑΣΤΙΧΟ ΨΕΚΑΣΤΗΡΩΝ 10, 12, 16Lt

Barcode	Icon	Volume	Unit
13723		(R3710-3)	1

ΑΝΤΑΛΛΑΚΤΙΚΗ ΑΝΤΛΙΑ ΨΕΚΑΣΤΗΡΩΝ 12, 16Lt

Barcode	Icon	Volume	Unit
13744		(R3710-4)	1



ΙΜΑΝΤΑΣ ΨΕΚΑΣΤΗΡΩΝ

Barcode	Icon	Volume	Unit
02529		No 107	10



ΛΑΒΗ ΨΕΚΑΣΤΗΡΑ ΠΛΑΤΗΣ

Barcode	Icon	Volume	Unit
10985		Για MIURA 12-16-22Lt	1



12652



12475



12505



ΛΑΒΗ ΕΜΒΟΛΟΥ ΨΕΚΑΣΤΗΡΑ ΠΡΟΠΙΕΣΗΣ 10lt

12652	R3710-9	1

ΣΚΑΝΔΑΛΗ ΑΥΛΟΥ ΨΕΚΑΣΤΗΡΑ

12475	R3710-2	1

ΑΥΛΟΣ ΨΕΚΑΣΤΗΡΑ

12505	R3710-1	1



01640



02140



02235



01591



02178



02219



01027



02220



ΑΥΛΟΣ ΜΕ ΣΚΑΝΔΑΛΗ

01640	0.60 m	5
02235	0.80 m	5
02178	1.00 m	5
01027	1.50 m	5

ΑΥΛΟΣ ΜΕ ΚΡΟΥΝΟ

02140	0.50 m	5
01591	0.80 m	5
02219	1.00 m	5
02220	1.50 m	5



ΑΥΛΟΣ ΠΛΑΣΤΙΚΟΣ ΨΕΚΑΣΤΗΡΑ

13366		5



ΑΥΛΟΣ ΨΕΚΑΣΤΗΡΑ ΙΤΑΛΙΑΣ

04211	8501BOX	4



ΜΠΕΚ ΑΥΛΟΥ ΨΕΚΑΣΤΗΡΑ ΙΤΑΛΙΑΣ

07927	8806BOX	1



02188



02088



02058



ΜΠΕΚ Α' (ΑΠΛΟ)

02188	No44	10



ΜΠΕΚ ΨΕΚΑΣΤΗΡΑ ΡΥΘΜΙΖΟΜΕΝΟ

02088	No7401 (Μεγάλο)	10



ΒΕΛΟΝΑ ΨΕΚΑΣΤΗΡΑ

02058	No 65	25



06244



08451



01439



05817



06244



08451



01439

ΒΙΔΕΣ ΟΡΕΙΧΑΛΚΙΝΟΥ ΨΕΚΑΣΤΗΡΑ

06244	Φλάντζας	10
08451	Αφαλού	10
01439	Ποδαρικού Νο 17	5



ΑΦΑΛΟΣ ΨΕΚΑΣΤΗΡΑ

05817		5



ΚΑΠΑΚΙ ΟΡΕΙΧΑΛΚΙΝΟΥ ΨΕΚΑΣΤΗΡΑ



01840



Χάλκινο Νο 67



1



01867



01946



01867



01946

ΣΟΥΡΩΤΗΡΙ ΠΛΑΣΤΙΚΟ



01867

Νο 50



5

ΛΑΣΤΙΧΟ ΨΕΚΑΣΤΗΡΑ Α'



01946

Δίσκος με τρύπες



10



00859



ΠΟΔΑΡΙΚΟ ΨΕΚΑΣΤΗΡΑ



00859



Νο 30



1



00653



02187



00653



02187

ΚΟΛΑΡΟ (ΛΑΣΤΙΧΟ)



00653

Νο 50



5

ΔΙΣΚΑΚΙΑ



02187

Νο 10



50



ΦΥΣΕΡΑ - ΥΔΡΟΝΕΤΕΣ

	01732		02227		01075
	01732		02227		01075
ΦΥΣΕΡΟ ΠΛΑΣΤΙΚΟ ΜΙΚΡΟ		ΦΥΣΕΡΟ ΠΛΑΣΤΙΚΟ ΜΕΓΑΛΟ		ΦΥΣΕΡΟ	
01732	1Kg	02227	2Kg	01075	Μεταλλικό
	5		5		2

ΠΛΑΣΤΙΚΟ ΔΟΧΕΙΟ ΥΔΡΟΝΕΤΑΣ	
01133	8,0 Lt
	6

ΦΥΣΕΡΟ ΠΛΑΤΗΣ	
03738	10Lt
	1

ΥΔΡΟΝΕΤΑ	
01718	5
	5

	02141		01720
	02141		01720
ΜΠΕΚ ΥΔΡΟΝΕΤΑΣ ΡΥΘΜΙΖΟΜΕΝΟ		ΑΝΤΑΛΛΑΚΤΙΚΑ ΥΔΡΟΝΕΤΩΝ	
02141	No 7403	01720	(Σετ Λαστιχάκια)
	10		50

■ NEW ARRIVAL ΝΕΑ ΑΦΙΞΗ ■ HOT SELLER ΚΑΛΥΤΕΡΟ ΣΤΗΝ ΠΩΛΗΣΗ ■ GET IT NOW ΑΞΙΖΕΙ ΝΑ ΑΓΟΡΑΣΕΙΣ ΤΩΡΑ



02625
00066
03451

BAHCO

BLISTER
GET IT NOW

ΛΙΜΑ ΑΛΥΣΟΠΡΙΟΝΩΝ

Barcode	Icon	Quantity
02625	5/32"	3x12
00066	3/16"	3x12
03451	7/32"	3x12



01405
05901
00667
00668
00670

Nicholson®

HOT SELLER
GET IT NOW

ΛΙΜΑ ΑΛΥΣΟΠΡΙΟΝΩΝ

Barcode	Icon	Quantity
01405	1/8"	12
05901	9/64"	12
00667	5/32"	12
00668	3/16"	12
00670	7/32"	12



00412
02862

BAHCO

ΛΙΜΑ ΟΒΕΡΓ ΠΡΙΟΝΟΚΟΡΔΕΛΑΣ

Barcode	Icon	Quantity
00412	7" - 175mm	10
02862	8" - 200mm	10



03452

BAHCO

ΛΙΜΑ ΓΙΑ ΠΡΙΟΝΙΑ ΤΥΠΟΥ WASA

Barcode	Icon	Quantity
03452	6" - 150mm	10



03925
03929

ΡΑΣΠΑ ΙΝΔΙΑΣ

Barcode	Icon	Quantity
03925	8" - 200mm	6
03929	10" - 250mm	6



01580
01581
01582

ΤΣΑΠΙ ΛΙΜΩΝ

Barcode	Icon	Quantity
01580	No1	20
01581	No2	20
01582	No3	20

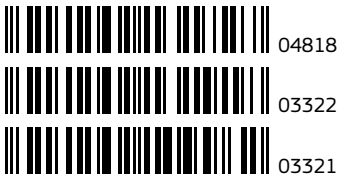

ΛΙΜΑ ΠΛΑΚΕ 4002 - EMB

Barcode	Icon	Quantity	
04818	6"	150mm	6
03322	8"	200mm	6
03321	10"	250mm	6

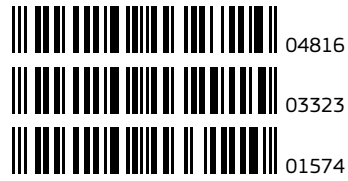

ΛΙΜΑ ΗΜΙΣΤΡΟΓΓΥΛΗ 4003 - EMB

Barcode	Icon	Quantity	
04816	6"	150mm	6
03323	8"	200mm	6
01574	10"	250mm	6



ΛΙΜΑ ΤΡΙΓΩΝΗ 4042 - VMB

Barcode	Icon	Quantity	
03324	5"	125mm	6
03325	6"	150mm	6
03326	7"	175mm	6
05573	8"	200mm	6



ΡΑΣΠΑ 4101 - EMB

Barcode	Icon	Quantity	
03328	8"	200mm	6
03327	10"	250mm	6



07719



ΛΙΜΑ ΠΕΤΑΛΩΤΗ

07719	4132-14" - 350mm	6



07720



ΛΙΜΑ ΠΕΤΑΛΩΤΗ

07720	code 4133 -16" - 400mm	6



00659



00660



00661



00662



ΛΙΜΑ TAPER ΤΡΙΓΩΝΗ

00659	5" - 125mm	12
00660	6" - 150mm	12
00661	7" - 175mm	12
00662	8" - 200mm	12



00663



00665



00666



ΛΙΜΑ SLIM ΤΡΙΓΩΝΗ

00663	4" - 100mm	12
00665	5" - 125mm	12
00666	6" - 150mm	12



03650



ΕΚΘΕΤΗΡΙΟ ΛΙΜΩΝ

03650	4450-V	1



NEW
ARRIVAL

ΜΑΤΣΑΚΟΝΙ FIBERGLASS ΛΑΒΗ

Barcode	Weight	Quantity
09153	300 gr	6



00166



00167



00168



ΒΑΡΙΟΠΟΥΛΑ ΞΥΛΙΝΗ ΛΑΒΗ

Barcode	Weight	Quantity
00166	800 gr	6
00167	1000 gr	6
00168	1250 gr	6



00171



00174



00172



00175



00173



00176



ΒΑΡΙΑ

Barcode	Weight	Quantity
00171	3 kg	6
00172	4 Kg	6
00173	5 Kg	4
00174	6 Kg	4
00175	7 Kg	4
00176	8 Kg	3

GET IT
NOW



GET IT NOW

BAPIA FIBERGLASS ΛΑΒΗ

04957	4 Kg	4



ΣΦΥΡΙ ΚΤΙΣΤΩΝ 5931-ΒΝ ΜΕ ΞΥΛΟ 335mm

01001	203X47,5mm (AxB) - 650 gr	6



GET IT NOW

ΣΦΥΡΙ ΚΤΙΣΤΩΝ

11285	1100	10



02218



01733



02218

01733

ΣΦΥΡΙ ΚΤΙΣΤΩΝ

02218	550 gr	5
01733	1000 gr	5



ΣΦΥΡΙ ΚΤΙΣΤΩΝ 5312 ΜΕ ΞΥΛΟ 400mm

01500	163X34mm (AxB) - 1120 gr	6



INTER



ΣΦΥΡΙ ΚΤΙΣΤΩΝ

 03539  1000 gr  6





ΣΦΥΡΙ ΠΙΚΟΥΝΙ - ΚΤΙΣΤΩΝ Α΄

 02118  950 gr  5





ΣΦΥΡΙ ΘΡΑΠΙΝΑ - ΚΤΙΣΤΩΝ Α΄

 03447  1000 gr  2





ΣΦΥΡΙ ΘΡΑΠΙΝΑ - ΜΥΤΗ Α΄

 04152  570 gr  5





**ΣΕΤ ΣΦΗΝΕΣ
 ΓΙΑ ΣΦΥΡΙΑ ΚΑΙ
 ΒΑΡΙΟΠΟΥΛΕΣ**

 08405  code 8976BL  5





ΣΦΥΡΙ ΘΡΑΠΙΝΑ

 01971  800 gr  5





HOT SELLER

ΣΚΕΡΠΑΝΙ ΚΑΛΟΥΠΑΤΖΗΔΩΝ

		
11283	420 gr	15





GET IT NOW

ΣΚΕΡΠΑΝΙ SPECIAL ΚΑΛΟΥΠΑΤΖΗΔΩΝ

		
11284	380 gr	12





HOT SELLER

ΣΚΕΡΠΑΝΙ ΚΑΛΟΥΠΑΤΖΗΔΩΝ 22650

		
03529	370 gr	6





GET IT NOW

ΣΚΕΡΠΑΝΙ ΚΑΛΟΥΠΑΤΖΗΔΩΝ 5938 SM

		
03134	320 gr	12





HOT SELLER

ΣΚΕΡΠΑΝΙ ΚΑΛΟΥΠΑΤΖΗΔΩΝ

		
01258	380 gr	2





ΣΚΕΡΠΑΝΙ ΣΚΕΠΑΤΖΗΔΩΝ

		
00204	570 gr	5

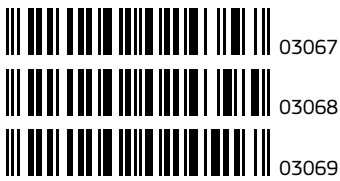

ΒΕΛΟΝΙ 5821

Barcode	Dimensions	Quantity
03067	250x16 mm	6
03068	300x16 mm	6
03069	350x18 mm	6



ΕΚΘΕΤΗΡΙΟ ΒΕΛΟΝΙΩΝ - ΚΟΠΙΔΙΩΝ

Barcode	Code	Quantity
01542	code 8952	1

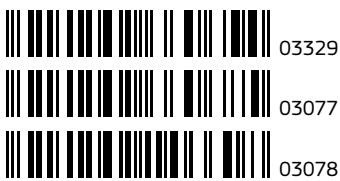

ΚΑΛΕΜΙ 8245

Barcode	Length	Quantity
03329	200 mm	6
03077	250 mm	6
03078	300 mm	6

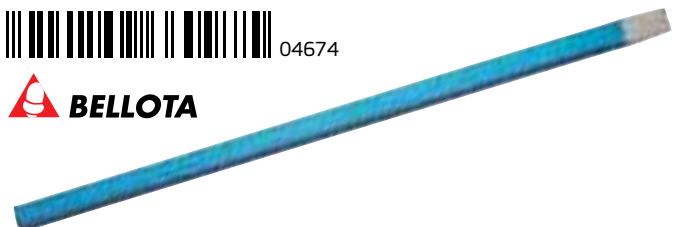
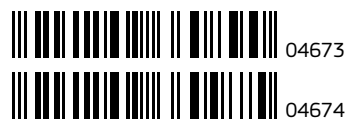

ΚΟΠΙΔΑΚΙ 8255

Barcode	Dimensions	Quantity
04673	200x8 mm	6
04674	250x10 mm	6

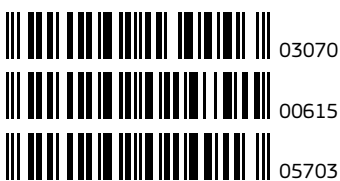

ΚΟΠΙΔΙ 5825

Barcode	Dimensions	Quantity
03070	250x16 mm	6
00615	300x16 mm	6
05703	350x18 mm	6

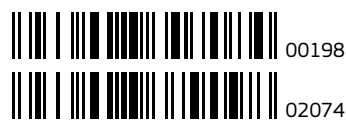

ΒΕΛΟΝΙ ΚΙΝΑΣ

Barcode	Length	Quantity
00198	250 mm	6
02074	300 mm	6

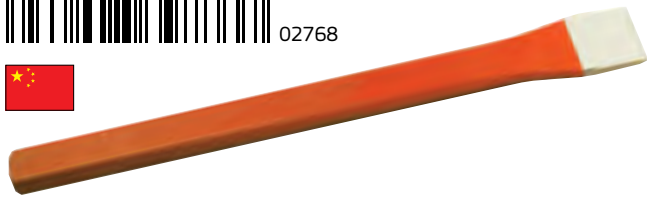
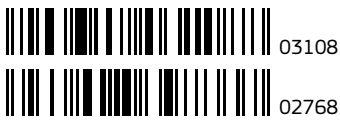

ΚΑΛΕΜΙ ΚΙΝΑΣ

Barcode	Length	Quantity
03108	250 mm	6
02768	300 mm	6

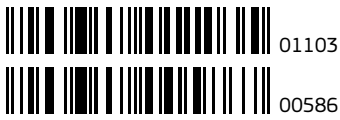

ΚΟΠΙΔΙ ΚΙΝΑΣ

Barcode	Length	Quantity
01103	250 mm	6
00586	300 mm	6

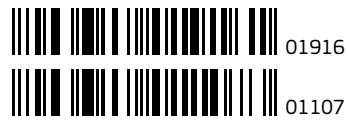

ΚΑΛΕΜΙ ΧΕΙΡΟΠΟΙΗΤΟ

Barcode	Length	Quantity
01916	60 mm	5
01107	110 mm	5

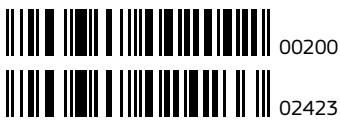

ΒΕΛΟΝΙ Α' ΧΕΙΡΟΠΟΙΗΤΟ

Barcode	Length	Quantity
00200	250 mm	5
02423	300 mm	5

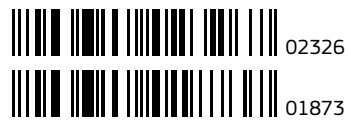

ΚΑΛΕΜΙ ΠΛΑΚΕ

Barcode	Description	Quantity
02326	Α' φαρδύ - πλάτος 40 mm	5
01873	με δόντια - πλάτος 35 mm	5



ΚΟΠΙΔΙ Α' ΧΕΙΡΟΠΟΙΗΤΟ

Barcode	Length	Quantity
00078	250 mm	5
00288	300 mm	5

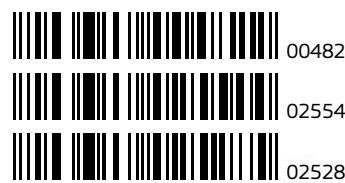
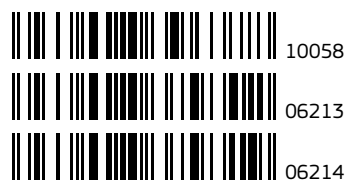

ΛΟΣΤΟΣ ΧΕΙΡΟΠΟΙΗΤΟΣ ΑΤΣΑΛΙΝΟΣ

Barcode	Product Code	Description	Quantity
	00720	μήκος 1,30 m - Φ30mm	3
	00719	μήκος 1,50 m - Φ30mm	3
	01455	μήκος 1,70 m - Φ30mm	3
	06461	μήκος 2,00 m - Φ25mm	3
	15246	μήκος 2,50 m - Φ25mm	3

ΛΟΣΤΟΣ ΕΞΑΓΩΝΟΣ Φ25 mm

Barcode	Product Code	Description	Quantity
	10058	μήκος 1,20m	3
	06213	μήκος 1,52m	3
	06214	μήκος 1,80m	3

ΛΟΣΤΟΣ ΧΕΙΡΟΠΟΙΗΤΟΣ Φ30 mm ΣΙΔΕΡΕΝΙΟΣ

Barcode	Product Code	Description	Quantity
	09674	μήκος 1,15m	3
	02619	μήκος 1,30m	3
	01865	μήκος 1,50m	3
	00148	μήκος 1,70m	3

ΛΟΣΤΟΣ ΕΞΑΓΩΝΟΣ Φ24mm

Barcode	Product Code	Description	Quantity
	00482	μήκος 1,30m	3
	02554	μήκος 1,50m	3
	02528	μήκος 1,70m	3

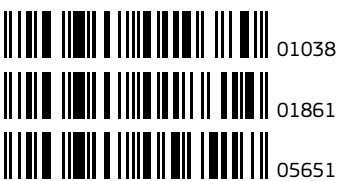

ΠΡΟΚΟΒΓΑΛΤΗΣ ΕΞΑΓΩΝΟΣ Φ17 mm

Barcode	Product Code	Description	Quantity
	03830	400 mm	2
	01988	600 mm	2
	00295	800 mm	2

ΠΡΟΚΟΒΓΑΛΤΗΣ ΕΞΑΓΩΝΟΣ Φ19 mm

Barcode	Product Code	Description	Quantity
	01038	1000 mm	2
	01861	1500 mm	2
	05651	2000 mm	2



ΠΡΟΚΟΒΓΑΛΤΗΣ ΕΞΑΓΩΝΟΣ

Barcode	Product Code	Description	Quantity
	01082	600x18 mm	5



ΠΡΟΚΟΒΓΑΛΤΗΣ ΕΞΑΓΩΝΟΣ 5982

Barcode	Product Code	Description	Quantity
	02323	600x20 mm	6

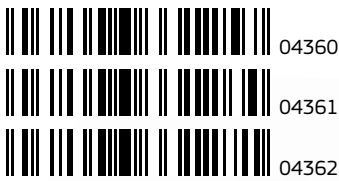

04360

04361

04362

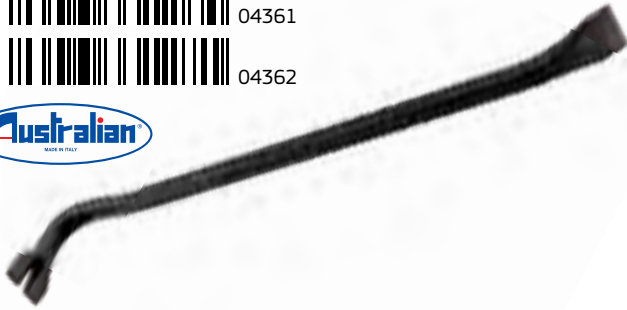

ΠΡΟΚΟΒΓΑΛΤΗΣ ΕΞΑΓΩΝΟΣ

Barcode	Icon	Icon
04360	500x18 mm	6
04361	600x18 mm	6
04362	800x18 mm	6

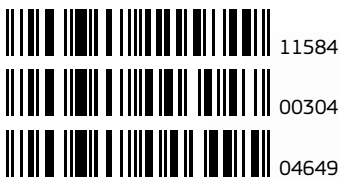

11584

00304

04649



NEW
ARRIVAL

ΚΛΕΙΔΙ ΜΠΕΤΟΥ

Barcode	Icon	Icon
11584	8x10 mm	5
00304	10x12 mm	5
04649	12x14 mm	4

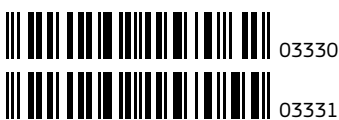

03330

03331



ΚΛΕΙΔΙ ΜΠΕΤΟΥ 5985

Barcode	Icon	Icon
03330	12 mm - 825 gr	2
03331	14 mm - 1300 gr	2



05489

05647

05490

05237

05774

05840

05258

06970

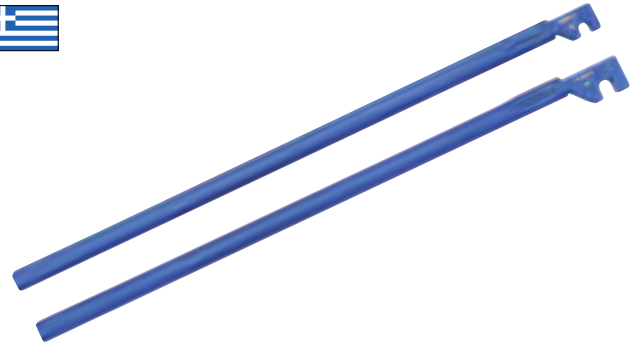

ΚΛΕΙΔΙ ΜΠΕΤΟΥ ΧΕΙΡΟΠΟΙΗΤΟ

Barcode	Icon	Icon
05489	10 mm	2
05490	12 mm	2
05774	14 mm	2
05258	16 mm	2
05647	18 mm	2
05237	20 mm	2
05840	22 mm	2
06970	25 mm	2

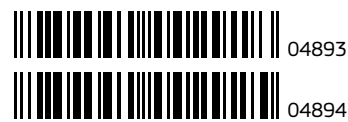

04893

04894



ΜΥΣΤΡΙΑ ΗΛΕΚΤΡΟΛΟΓΩΝ ΞΥΛΙΝΗ ΛΑΒΗ 646

Barcode	Icon	Icon
04893	μήκος 120 mm	6
04894	μήκος 140 mm	6



ΜΥΣΤΡΙΑ ΗΛΕΚΤΡΟΛΟΓΩΝ ΞΥΛΙΝΗ ΛΑΒΗ

Barcode	Icon	Icon
01320	μήκος 140 mm	12



04895



04896



ΜΥΣΤΡΙΑ ΗΛΕΚΤΡΟΛΟΓΩΝ ΛΑΣΤΙΧΕΝΙΑ ΛΑΒΗ 6461

Barcode	Icon	Unit
04895	✂	μήκος 120 mm 6
04896	✂	μήκος 140 mm 6

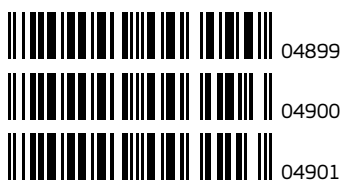

04899



04900



04901



ΜΥΣΤΡΙΑ ΚΤΙΣΤΩΝ ΛΑΣΤΙΧΕΝΙΑ ΛΑΒΗ 6491

Barcode	Icon	Unit
04899	✂	μήκος 152 mm 6
04900	✂	μήκος 178 mm 6
04901	✂	μήκος 200 mm 6

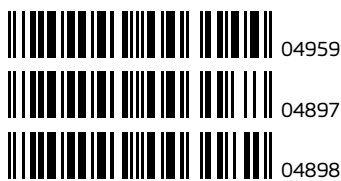

04959



04897



04898



ΜΥΣΤΡΙΑ ΚΤΙΣΤΩΝ ΞΥΛΙΝΗ ΛΑΒΗ 649

Barcode	Icon	Unit
04959	✂	μήκος 152 mm 6
04897	✂	μήκος 178 mm 6
04898	✂	μήκος 200 mm 6



04887

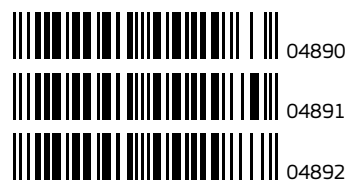

04890



04888



04891



04889



04892



ΜΥΣΤΡΙΑ ΣΟΒΑΤΖΗΔΩΝ ΛΑΣΤΙΧΕΝΙΑ ΛΑΒΗ 6471

Barcode	Icon	Unit
04887	✂	μήκος 180 mm 6
04888	✂	μήκος 200 mm 6
04889	✂	μήκος 220 mm 6
04890	✂	μήκος 240 mm 6
04891	✂	μήκος 260 mm 6
04892	✂	μήκος 280 mm 6



04881



04882



04883



04884



04885



ΜΥΣΤΡΙΑ ΣΟΒΑΤΖΗΔΩΝ ΞΥΛΙΝΗ ΛΑΒΗ 647

Barcode	Icon	Unit
04881	✂	μήκος 180 mm 6
04882	✂	μήκος 200 mm 6
04883	✂	μήκος 220 mm 6
04884	✂	μήκος 240 mm 6
04885	✂	μήκος 260 mm 6



ΜΥΣΤΡΙΑ ΤΥΠΟΥ ΚΡΗΤΗΣ ΛΑΣΤΙΧΕΝΙΑ ΛΑΒΗ 6201

Barcode	Icon	Icon
05945	μήκος 180 mm	6
05946	μήκος 200 mm	6
05947	μήκος 220 mm	6
05948	μήκος 240 mm	6
05949	μήκος 260 mm	6



INTER



GET IT NOW

ΜΥΣΤΡΙΑ ΣΟΒΑΤΖΗΔΩΝ ΛΑΣΤΙΧΕΝΙΑ ΛΑΒΗ

Barcode	Icon	Icon
05694	μήκος 180 mm	12
05695	μήκος 200 mm	12
05696	μήκος 220 mm	12
05697	μήκος 240 mm	12
05698	μήκος 260 mm	12



ΜΥΣΤΡΙΑ ΣΟΒΑΤΖΗΔΩΝ ΞΥΛΙΝΗ ΛΑΒΗ 5857

Barcode	Icon	Icon
03971	μήκος 180 mm	6
00362	μήκος 200 mm	6
03071	μήκος 220 mm	6
03072	μήκος 240 mm	6



ΜΥΣΤΡΙΑ ΣΟΒΑΤΖΗΔΩΝ ΞΥΛΙΝΗ ΛΑΒΗ

Barcode	Icon	Icon
02851	μήκος 180 mm	12
01910	μήκος 200 mm	12
01911	μήκος 220 mm	12
01912	μήκος 240 mm	12
01913	μήκος 260 mm	12



ΜΥΣΤΡΙΑ ΑΡΜΟΥ 5897

Barcode	Icon	Icon
11973	6x180 mm	6



INTER



ΜΥΣΤΡΙΑ ΗΛΕΚΤΡΟΛΟΓΩΝ ΛΑΣΤΙΧΕΝΙΑ ΛΑΒΗ

Barcode	Icon	Icon
14458	μήκος 140 mm	12

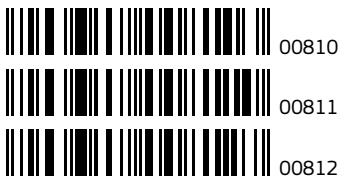

00810

00811

00812



ΜΥΣΤΡΙΑ ΚΤΙΣΤΩΝ ΞΥΛΙΝΗ ΛΑΒΗ

00810	μήκος 152 mm	10
00811	μήκος 178 mm	10
00812	μήκος 200 mm	12



ΤΡΙΒΙΔΙ ΧΕΙΡΟΣ ΞΥΛΙΝΟ

04251	400x80 mm	5



Morgan.



ΜΗΧΑΝΗ ΣΑΓΡΕ

05595	code 6340	3



GET IT NOW

ΤΡΙΒΙΔΙ ΠΑΤΟΧΑΡΤΟΥ ΧΕΙΡΟΣ ΜΕ ΔΑΓΚΑΝΕΣ

06463	220x115 mm	6



ΤΡΙΒΙΔΙ ΠΑΤΟΧΑΡΤΟΥ ΚΟΝΤΑΡΙΟΥ ΑΦΡΩΔΕΣ

02780	210x120 mm (με πεταλούδες)	5



ΤΡΙΒΙΔΙ ΠΑΤΟΧΑΡΤΟΥ ΧΕΙΡΟΣ ΑΦΡΩΔΕΣ

01699	210x115 mm (με πεταλούδες)	10



ΤΡΙΒΙΔΙ ΠΑΤΟΧΑΡΤΟΥ ΚΟΝΤΑΡΙΟΥ ΜΕ ΔΑΓΚΑΝΕΣ ΑΦΡΩΔΕΣ

05553	220x100 mm	5



Morgan.



ΤΡΙΒΙΔΙ LATEX ΦΑΡΔΥ 6325

		
05596	210x125x15 mm	12



ARISTON



ΤΡΙΒΙΔΙ ΑΦΡΩΔΕΣ ΠΟΛΥΟΥΡΕΘΑΝΗΣ ΠΛΑΣΤΙΚΗ ΛΑΒΗ 10124

		
01897	320x90x15 mm	5







ΤΡΙΒΙΔΙ LATEX ΦΑΡΔΥ ΜΠΛΕ

		
01700	220x140x15 mm	4



ARISTON



ΤΡΙΒΙΔΙ ΑΦΡΩΔΕΣ ΠΟΛΥΟΥΡΕΘΑΝΗΣ ΠΛΑΣΤΙΚΗ ΛΑΒΗ 10114

HOT SELLER

		
03287	230x130x30 mm	5







ΤΡΙΒΙΔΙ LATEX ΦΑΡΔΥ ΠΟΡΤΟΚΑΛΙ

		
02564	220x140x15 mm	4



ARISTON



ΤΡΙΒΙΔΙ ΑΦΡΩΔΕΣ ΠΟΛΥΟΥΡΕΘΑΝΗΣ ΠΛΑΣΤΙΚΗ ΛΑΒΗ 10112

HOT SELLER

		
03656	265x165x30 mm	5







ΤΡΙΒΙΔΙ LATEX ΣΤΕΝΟ ΜΠΛΕ

		
02778	370x70x15 mm	5



15177



12724

ARISTON



ΤΡΙΒΙΔΙ ΑΦΡΩΔΕΣ ΠΟΛΥΟΥΡΕΘΑΝΗΣ ΠΛΑΣΤΙΚΗ ΛΑΒΗ - ΒΑΣΗ ΑΛΟΥΜΙΝΙΟΥ

NEW ARRIVAL

		
15177	code 10144 - 420x90x15 mm	5
12724	code 10142 - 500x90x15 mm	5



ΤΡΙΒΙΔΙΑ - ΣΤΟΚΑΔΟΡΟΙ - ΣΦΟΥΓΓΑΡΙΑ



ΤΡΙΒΙΔΙ ΦΕΛΙΖΟΛ ΜΕ ΠΛΑΣΤΙΚΗ ΛΑΒΗ

01702	240x140x50 mm	7
01704	ανταλλακτικό	5



ΤΡΙΒΙΔΙ ΟΛΟ ΦΕΛΙΖΟΛ

01703	260x145x45 mm	60



ΛΑΒΗ ΠΛΑΣΤΙΚΗ ΓΙΑ ΤΡΙΒΙΔΙΑ ΦΕΛΙΖΟΛ

02097	χωρίς πεταλούδες	10



GET IT NOW

ΣΤΟΚΑΔΟΡΟΣ ΜΕ ΛΑΣΤΙΧΟ

02640	235x97 mm	5



ΤΡΙΒΙΔΙ ΤΣΙΜΕΝΤΟΚΟΝΙΑΣ 10116

13478	265x165x15 mm	5



ΣΦΟΥΓΓΑΡΙ ΜΕ ΛΑΒΗ 10122

04578	265x165x30 mm	10
12728	ανταλλακτικό	10



ΠΕΤΑΛΟΥΔΑ ΜΕ ΣΤΗΡΙΓΜΑ

02258		10



ΣΦΟΥΓΓΑΡΙ ΜΕ ΛΑΒΗ 10126

13335	230x130x30 mm	10



ARISTON

NEW ARRIVAL

ΣΦΟΥΓΓΑΡΙ ΧΑΡΑΚΩΤΟ ΜΕ ΛΑΒΗ 10234

14748	280x140x30 mm	12
-------	---------------	----



ARISTON

HOT SELLER

ΣΦΟΥΓΓΑΡΙ 10122B

09112	170x110x70 mm	12
-------	---------------	----





ΣΦΟΥΓΓΑΡΙ ΛΑΜΙΟΠΛΑΣΤ

05438	260x160x30	10
-------	------------	----



BELLOTA

11312
11313
14783

ΚΑΘΑΡΙΣΤΗΡΑΣ ΔΑΠΕΔΟΥ 5886F

ΚΩΔΙΚΟΣ ΞΥΛΟΥ
06113 (1,2m)
01909 (1,5m)

11312	450 mm	12
11313	600 mm	12
14783	750 mm	12





00627
00628
00629

ΚΑΘΑΡΙΣΤΗΡΑΣ ΔΑΠΕΔΟΥ

ΚΩΔΙΚΟΣ ΞΥΛΟΥ
06113 (1,2m)
01909 (1,5m)

00627	μήκος 350 mm	5
00628	μήκος 450 mm	5
00629	μήκος 600 mm	5



ARISTON

13576
13709

ΕΠΙΣΤΡΩΤΗΣ ΜΠΕΤΟΥ

13576	code 10240 - 650x70 mm	1
13709	code 10276 - 750x70 mm	1



ΦΡΑΓΚΟΦΤΥΑΡΟ ΜΕ ΛΑΒΗ 3 ΘΕΣΕΩΝ

02872	500x330 mm	5
-------	------------	---

HOT SELLER



ΦΡΑΓΚΟΦΤΥΑΡΟ ΑΛΟΥΜΙΝΙΟΥ 10238

13575	370x330 mm	1
-------	------------	---



ΛΑΒΕΣ ΓΙΑ ΦΡΑΓΚΟΦΤΥΑΡΑ

01209	ίσα ή λοξή	5
-------	------------	---



ΔΙΑΜΑΝΤΙ ΤΖΑΜΙΩΝ

00337	3-8 mm	12
-------	--------	----



ΔΙΑΜΑΝΤΙ ΤΖΑΜΙΩΝ Νο 100

04730	3-10 mm	12
-------	---------	----



ΠΕΝΣΑ ΤΟΠΟΘΕΤΗΣΗΣ ΑΠΟΣΤΑΤΩΝ ΠΛΑΚΙΔΙΩΝ

13844		1
-------	--	---



ΥΑΛΟΚΑΘΑΡΙΣΤΗΡΑΣ ΣΚΕΤΟΣ ΜΕ ΛΑΣΤΙΧΟ

02865	μήκος 250 mm	6
15138	μήκος 350 mm	6
06551	μήκος 450 mm	6

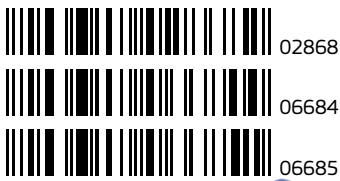

ΥΑΛΟΚΑΘΑΡΙΣΤΗΡΑΣ ΜΕ ΣΦΟΥΓΓΑΡΙ & ΛΑΣΤΙΧΟ

Barcode	Icon	Quantity
02868	✍	μήκος 250 mm 6
06684	✍	μήκος 300 mm 6
06685	✍	μήκος 350 mm 6

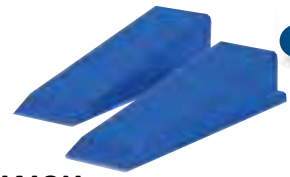

GET IT NOW

ΠΑΡΕΜΒΥΣΜΑΤΑ ΠΛΑΚΙΔΙΩΝ ΣΦΗΝΕΣ ΓΙΑ ΑΠΟΣΤΑΤΕΣ 100αδα

Barcode	Icon	Quantity
13840	✍	1



NEW ARRIVAL

ΠΑΡΕΜΒΥΣΜΑΤΑ ΜΑΡΜΑΡΩΝ 14-22 mm ΑΠΟΣΤΑΤΗΣ 100αδα

Barcode	Icon	Quantity
14750	✍	1 mm 1



ΠΑΡΕΜΒΥΣΜΑΤΑ ΠΛΑΚΙΔΙΩΝ ΣΦΗΝΕΣ 100αδα

Barcode	Icon	Quantity
06559	✍	1



ΠΑΡΕΜΒΥΣΜΑΤΑ ΠΛΑΚΙΔΙΩΝ ΣΤΑΥΡΟΥ 100αδα

Barcode	Icon	Quantity
13046	✍	πάχος 1 mm 0,5
03702	✍	πάχος 2 mm 1
01170	✍	πάχος 3 mm 1
03703	✍	πάχος 4 mm 1
01171	✍	πάχος 5 mm 1
05904	✍	πάχος 7 mm 0,25
05905	✍	πάχος 10 mm 0,25



ΠΑΡΕΜΒΥΣΜΑΤΑ ΠΛΑΚΙΔΙΩΝ ΑΠΟΣΤΑΤΕΣ 100αδα

Barcode	Icon	Quantity
14749	✍	πάχος 0,5 mm 1
13841	✍	πάχος 1 mm 1
14016	✍	πάχος 1,5 mm 1
13842	✍	πάχος 2 mm 1
13843	✍	πάχος 3 mm 1

NEW ARRIVAL

GET IT NOW

HOT SELLER



ΠΑΡΕΜΒΥΣΜΑΤΑ ΠΛΑΚΙΔΙΩΝ ΤΑΦ 500αδα

Barcode	Icon	Icon
06083	πάχος 2 mm	1
01172	πάχος 3 mm	1
03570	πάχος 4 mm	1
06558	πάχος 5 mm	1
03571	πάχος 7 mm	1
03041	πάχος 9 mm	1



sigma
COSTRUZIONE MACCHINE PER PIASTRELLISTI



ΚΟΦΤΗΣ ΠΛΑΚΙΔΙΩΝ 6

Barcode	Icon	Icon
04455	μήκος κοπής 35 cm	1



sigma
COSTRUZIONE MACCHINE PER PIASTRELLISTI



ΚΟΦΤΗΣ ΠΛΑΚΙΔΙΩΝ 2G

Barcode	Icon	Icon
06509	μήκος κοπής 37 cm	1



sigma
COSTRUZIONE MACCHINE PER PIASTRELLISTI



ΚΟΦΤΗΣ ΠΛΑΚΙΔΙΩΝ 5A

Barcode	Icon	Icon
04448	μήκος κοπής 51 cm	1



sigma
COSTRUZIONE MACCHINE PER PIASTRELLISTI



ΚΟΦΤΗΣ ΠΛΑΚΙΔΙΩΝ 7F

Barcode	Icon	Icon
06584	μήκος κοπής 37 cm	1



sigma
COSTRUZIONE MACCHINE PER PIASTRELLISTI

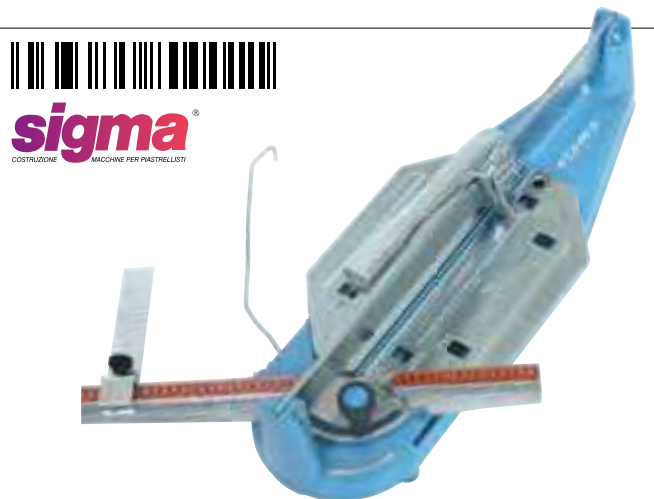

ΚΟΦΤΗΣ ΠΛΑΚΙΔΙΩΝ 2A3

Barcode	Icon	Icon
06583	μήκος κοπής 51 cm	1

ΚΟΦΤΕΣ ΠΛΑΚΙΔΙΩΝ



NEW ARRIVAL

sigma
COSTRUZIONE MACCHINE PER PIASTRILLISTI

ΚΟΦΤΗΣ ΠΛΑΚΙΔΙΩΝ 4BU

15645 μήκος κοπής 70 cm 1



NEW ARRIVAL

sigma
COSTRUZIONE MACCHINE PER PIASTRILLISTI

ΚΟΦΤΗΣ ΠΛΑΚΙΔΙΩΝ 4EN

15140 μήκος κοπής 125 cm 1



sigma
COSTRUZIONE MACCHINE PER PIASTRILLISTI

ΚΟΦΤΗΣ ΠΛΑΚΙΔΙΩΝ 4CU

15654 μήκος κοπής 84 cm 1



NEW ARRIVAL

sigma
COSTRUZIONE MACCHINE PER PIASTRILLISTI

ΚΟΦΤΗΣ ΠΛΑΚΙΔΙΩΝ 4FN

15141 μήκος κοπής 155 cm 1



NEW ARRIVAL

sigma
COSTRUZIONE MACCHINE PER PIASTRILLISTI

ΚΟΦΤΗΣ ΠΛΑΚΙΔΙΩΝ 4DU

15139 μήκος κοπής 103 cm 1



sigma
COSTRUZIONE MACCHINE PER PIASTRELLISTI

NEW
ARRIVAL



ΚΟΦΤΗΣ ΠΛΑΚΙΔΙΩΝ 12Ε1

14406	μήκος κοπής 245 cm	1



sigma
COSTRUZIONE MACCHINE PER PIASTRELLISTI

NEW
ARRIVAL



ΚΟΦΤΗΣ ΠΛΑΚΙΔΙΩΝ 8ΑΕ2 (ΚΕΡΑ-CUT)

15037	μήκος κοπής 332 cm	1



sigma
COSTRUZIONE MACCHINE PER PIASTRELLISTI

NEW
ARRIVAL



ΜΗΧΑΝΗΜΑ ΔΙΑΜΟΡΦΩΣΗΣ ΠΡΟΦΙΛ ΠΛΑΚΙΔΙΩΝ 37A3D (JOLLY EDGE)

14391	φάλτσο - κούρμπα	1



sigma
COSTRUZIONE MACCHINE PER PIASTRELLISTI

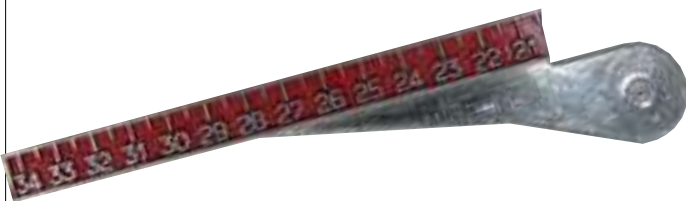

ΟΔΗΓΟΣ ΑΠΛΟΣ

06508	17 για Art. 6	1



sigma
COSTRUZIONE MACCHINE PER PIASTRELLISTI



ΒΙΔΑ ΜΠΑΡΑΣ

06582	20A για 3D, 3EK, 4A, 4B	1



sigma
COSTRUZIONE MACCHINE PER PIASTRELLISTI



ΒΙΔΑ ΟΔΗΓΟΥ (Φ60 mm)

05729	92 για 4A	1



sigma
COSTRUZIONE MACCHINE PER PIASTRELLISTI



ΧΑΡΑΚΑΣ ΓΩΝΙΑΚΟΣ

06585	19F για 7F	1
05725	19A για 4A, 5A	1



sigma
COSTRUZIONE MACCHINE PER PIASTRELLISTI



ΟΔΗΓΟΣ ΚΟΜΠΛΕ

05728	90 για 4A-4AK	1
05726	90B για 5A-5AK	1
05727	90C για 5B-5BK	1

04452
04453

sigma
COSTRUZIONE MACCHINE PER PIASTRELLISTI

ΧΕΡΟΥΛΙ

Barcode	Description	Quantity
04452	24E για 5A, 5B, 3B4, 6	1
04453	24AE για 4A, 3D2, 3C2	1

15368
13595

sigma
COSTRUZIONE MACCHINE PER PIASTRELLISTI

ΧΕΡΟΥΛΙ

Barcode	Description	Quantity
15368	24M15X για 3E4M, 3EK	1
13595	24M20X για 3F4M	1

sigma
COSTRUZIONE MACCHINE PER PIASTRELLISTI

ΧΕΡΟΥΛΙ (ΣΕΙΡΑ «NEX»)

Barcode	Description	Quantity
15367	24N για 4BU, 4CU, 4DU, 4EN, 4FN	1

sigma
COSTRUZIONE MACCHINE PER PIASTRELLISTI

ΧΕΡΟΥΛΙ (ΣΕΙΡΑ «UP»)

Barcode	Description	Quantity
15366	24U για 4BU, 4CU, 4DU, 4EN, 4FN	1

15238
15239
15240
15241

sigma
COSTRUZIONE MACCHINE PER PIASTRELLISTI

ΤΡΥΠΑΝΙ ΠΛΑΚΙΔΙΩΝ ΔΙΑΜΑΝΤΕ (ΕΞΑΓΩΓΗ ΥΠΟΔΟΧΗ)

Barcode	Description	Quantity
15238	code 53006 - Φ 6mm	1
15239	code 53008 - Φ 8mm	1
15240	code 53010 - Φ 10mm	1
15241	code 53012 - Φ 12mm	1

15361
15362
15363

ΤΡΥΠΑΝΙ ΠΛΑΚΙΔΙΩΝ «FAST» (ΥΠΟΔΟΧΗ M14)

Barcode	Description	Quantity
15361	code 53020 - Φ 20mm	1
15362	code 53025 - Φ 25mm	1
15363	code 53070 - Φ 70mm	1



sigma
COSTRUZIONE MACCHINE PER PIASTRELLISTI

NEW
ARRIVAL



ΠΑΓΚΟΣ ΕΡΓΑΣΙΑΣ ΑΛΟΥΜΙΝΙΟΥ

15360 code 63E - 180x96 cm 1



sigma
COSTRUZIONE MACCHINE PER PIASTRELLISTI

NEW
ARRIVAL



ΣΥΣΤΗΜΑ ΧΕΙΡΙΣΜΟΥ ΜΕΓΑΛΩΝ ΠΛΑΚΙΔΙΩΝ ΚΕΡΑ-LIFT 1A4

15646 340x160cm 1



sigma
COSTRUZIONE MACCHINE PER PIASTRELLISTI

NEW
ARRIVAL



ΚΙΤ ΣΤΕΡΕΩΣΗΣ ΤΡΑΠΕΖΙΟΥ

15376 code 37C για 37A 1



sigma
COSTRUZIONE MACCHINE PER PIASTRELLISTI

NEW
ARRIVAL



ΔΙΣΚΟΣ ΛΕΙΑΝΣΗΣ ΔΙΑΜΑΝΤΕ ΚΟΥΠΑ

15375 72L - Ø115mm 1



sigma
COSTRUZIONE MACCHINE PER PIASTRELLISTI

NEW
ARRIVAL



ΠΑΣΤΑ ΨΥΞΗΣ ΓΙΑ ΞΗΡΟ ΤΡΥΠΗΜΑ

15364 code 53G - δοχείο 30 ml 1

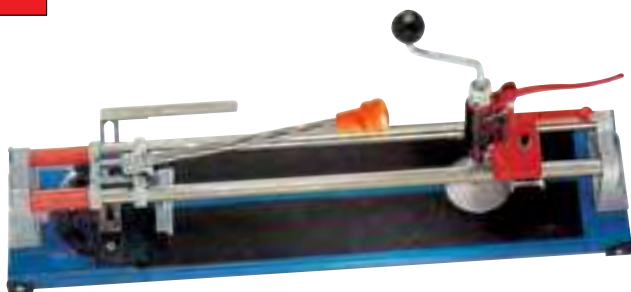

ΚΟΦΤΗΣ ΠΛΑΚΙΔΙΩΝ ΜΕ ΤΡΥΠΑΝΙ

06050	μήκος κοπής 600mm	1



01467



02434



ΚΟΦΤΗΣ ΠΛΑΚΙΔΙΩΝ ΤΑΪΒΑΝ

01467	μήκος κοπής 400 mm	1
02434	μήκος κοπής 500 mm	1



04451



13389



13388



15365



12324



ΡΟΔΑΚΙ ΚΟΠΗΣ

04451	14A - Φ12 mm	10
13389	14C - Φ16 mm	10
13388	14MX - Φ19 mm	10
15365	14N - Φ16mm	10
12324	τιτανίου 14T - Φ12 mm	10



ΣΤΥΛΟ ΠΛΑΚΙΔΙΩΝ

03965		5



ΑΝΩ ΠΛΕΥΡΑ
41 cm



ΥΨΟΣ
35 cm



ΚΑΤΩ
ΠΛΕΥΡΑ
35 cm

ΣΚΑΦΗ ΚΟΛΛΑΣ ΤΕΤΡΑΓΩΝΗ

03891	50 lt	5

GET IT NOW



ΑΝΩ Φ 46 cm



ΥΨΟΣ
35 cm



ΚΑΤΩ
36 cm

ΚΟΥΒΑΣ ΜΕ ΠΛΑΪΝΗ ΛΑΒΗ

06034	45 lt	5

HOT SELLER



ΚΟΥΒΑΣ ΠΛΑΚΑΔΩΝ 5800-3

10176	20 lt	1

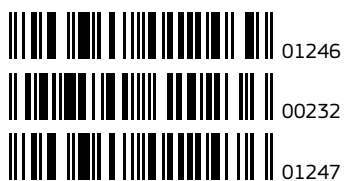

ΣΚΑΦΗ ΟΙΚΟΔΟΜΩΝ ΠΛΑΣΤΙΚΗ

Barcode	Icon	Volume	Quantity
01246		13 lt	10
00232		25 lt	5
01247		30 lt	5

GET IT NOW

HOT SELLER

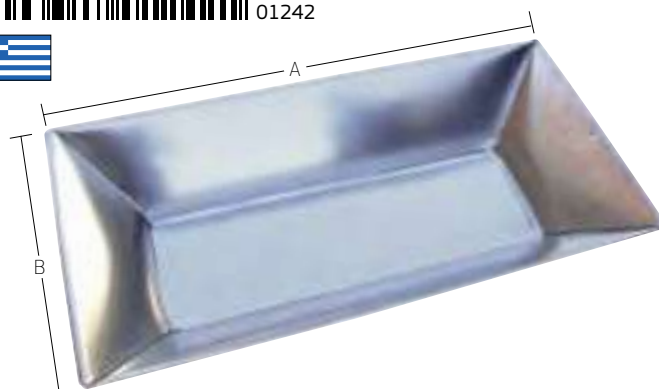
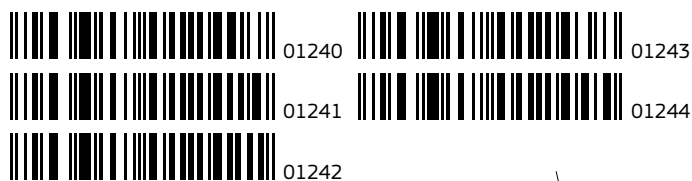

ΣΚΑΦΗ ΓΑΛΒΑΝΙΖΕ

Barcode	Icon	Code	Dimensions	Quantity
01240		code No 75	620x370 mm (AxB)	1
01241		code No 90	750x450 mm (AxB)	1
01242		code No 100	840x480 mm (AxB)	1
01243		code No 110	910x520 mm (AxB)	1
01244		code No 125	1040x550 mm (AxB)	1



ΚΟΥΒΑΣ ΓΑΛΒΑΝΙΖΕ

Barcode	Icon	Model	Capacity	Quantity
00388		A'	15 lt	12
00389		B'	10 lt	12
00390		Γ'	7 lt	12
00391		Δ'	5 lt	12



ΚΟΥΒΑΣ ΟΙΚΟΔΟΜΗΣ ΜΕ ΣΤΟΜΙΟ ΠΛΑΣΤΙΚΟΣ

Barcode	Icon	Capacity	Quantity
01477		15 lt	10

GET IT NOW



ΚΟΥΒΑΣ ΟΙΚΟΔΟΜΗΣ ΠΛΑΣΤΙΚΟΣ ΒΚΤ26ΒΜ

Barcode	Icon	Capacity	Quantity
14029		26 lt	6

GET IT NOW



ΚΟΥΒΑΣ ΟΙΚΟΔΟΜΗΣ ΠΛΑΣΤΙΚΟΣ

Barcode	Icon	Capacity	Quantity
02580		10 lt	5
03133		18 lt	5

GET IT NOW



ΚΟΥΒΑΣ ΑΓΡΟΤΙΚΟΣ

03268	18 lt	10



GET IT NOW



ΖΥΜΠΙΑ

00376	No 2	5



NEW ARRIVAL

HOT SELLER



ΖΥΜΠΙΑ ΠΟΛΥΑΙΘΥΛΕΝΙΟΥ

13674	code BKT42RP - κοκκίνο - max 42 kg	4
14558	code BKT42WP - λευκό - max 42 lt	4
14559	code BKT42BLP - μπλε - max 42 lt	4
08546	code BKT42BP μαύρο - max 42 lt	4
14560	code BKT65WP - λευκό - max 65 lt	4
14561	code BKT65BLP - μπλε - max 65 lt	4
14576	code BKT65BP - μαύρο - max 65 lt	4



ΚΑΡΟΤΣΑΚΙ ΚΗΠΟΥ ΠΛΑΣΤΙΚΟ

09323	30 kg	1

04303
08876



ΚΑΡΑΚΙ ΣΩΛΗΝΩΤΟ

04303	B' ρηχό	1
08876	ανταλ. σκάφη	1

09760 09761



ΚΑΡΟΤΣΑΚΙ ΓΙΑ ΤΕΛΑΡΑ

09760	τύπος ελαστικού: 4λινά	1
09761	τύπος ελαστικού: τρακτερωτό	1

03618 06502
03498 09141
04726



ΚΑΡΑΚΙ ΟΙΚΟΔΟΜΗΣ ΜΕ ΡΟΥΛΕΜΑΝ

03618	A' οικοδομών	1
03498	B' οικοδομών	1
04726	γερανού	1
06502	ανταλ. σκάφη A'	1
09141	ανταλ. σκάφη B'	1

00779 00780



ΛΑΣΤΙΧΟ ΧΕΙΡΑΜΑΞΑΣ 400-8

00779	2 λινά	5
00780	4 λινά	5

13742



ΛΑΣΤΙΧΟ ΧΕΙΡΑΜΑΞΑΣ 400-8

13742	πολυουρεθάνης	1
-------	---------------	---

05841



ΡΟΔΑ ΧΕΙΡΑΜΑΞΑΣ ΤΡΑΚΤΕΡΩΤΗ ΜΕ ΡΟΥΛΕΜΑΝ

05841	B	1
-------	---	---

11067



ΛΑΣΤΙΧΟ ΤΡΑΚΤΕΡΩΤΟ

11067	400-8	5
-------	-------	---

03734

02607

13740

HOT SELLER

03734	A'		1
02607	B'		1
13740	B' κοντή		1

00154

HOT SELLER

00154	400-8		10
-------	-------	--	----

04968

04969

11212

04968	A'		1
04969	B'		1
11212	B'		1

11736

13741

GET IT NOW

11736	B'		1
13741	B' κοντή		1

04851

04851	300-4		5
-------	-------	--	---

04850

06144

11069

11070

04850	πνευστή - μεταλλική ζάντα		1
06144	συμπαγής - μεταλλική ζάντα		1
11069	πνευστή - πλαστική ζάντα		1
11070	συμπαγής - πλαστική ζάντα		1

06144

11070



**ΚΑΡΟΤΣΑΚΙ ΠΛΑΤΦΟΡΜΑ
ΤΕΤΡΑΤΡΟΧΟ ΣΙΔΕΡΕΝΙΟ**



03788



αντοχή βάρους 150 kg



1



ΚΑΡΟΤΣΑΚΙ ΔΙΤΡΟΧΟ ΜΕ ΠΝΕΥΣΤΕΣ ΡΟΔΕΣ



06223



αντοχή βάρους 150 kg



1



**ΚΑΡΟΤΣΑΚΙ ΔΙΤΡΟΧΟ ΠΤΥΣΣΟΜΕΝΟ
ΑΛΟΥΜΙΝΙΟΥ**



03787



αντοχή βάρους 100 kg



1



ΑΛΦΑΔΙ 247

Barcode	Icon	Quantity
00032	μήκος 30 cm	2
00033	μήκος 40 cm	2
00034	μήκος 50 cm	2
00035	μήκος 60 cm	2



ΑΛΦΑΔΙ 248

Barcode	Icon	Quantity
00036	μήκος 30 cm	2
00038	μήκος 50 cm	2
00039	μήκος 60 cm	2
04949	μήκος 80 cm	2



ΑΛΦΑΔΙ ΜΑΓΝΗΤΙΚΟ 246

Barcode	Icon	Quantity
00045	μήκος 40 cm	2



ΑΛΦΑΔΙ ΑΛΟΥΜΙΝΙΟΥ

Barcode	Icon	Quantity
02059	μήκος 30 cm	6
00048	μήκος 80 cm	6



ΑΛΦΑΔΙ 245

Barcode	Icon	Quantity
00040	μήκος 70 cm	2
00041	μήκος 80 cm	2
00042	μήκος 100 cm	2
02615	μήκος 150 cm	2
05414	μήκος 200 cm	2



ΑΛΦΑΔΙ ΜΑΓΝΗΤΙΚΟ

Barcode	Icon	Quantity
00911	τορπίλη	5



ΠΕΛΜΑ ΓΙΑ ΠΗΧΕΙΣ (275)

Barcode	Icon	Quantity
06776	8x2 cm	10



ΠΗΧΗΣ ΒΑΡΕΩΣ ΤΥΠΟΥ ΑΛΟΥΜΙΝΙΟΥ

Barcode	Icon	Quantity
04611	μήκος 1,0 m	4
04318	μήκος 1,2 m	4
04319	μήκος 1,5 m	4
04503	μήκος 1,8 m	4
04504	μήκος 2,0 m	4
00546	μήκος 2,5 m	4
01441	μήκος 3,0 m	4

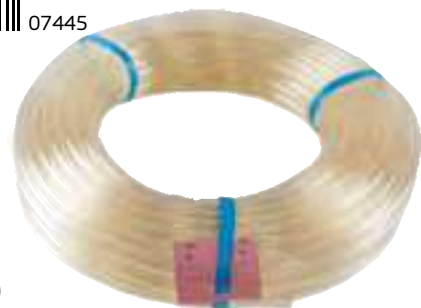
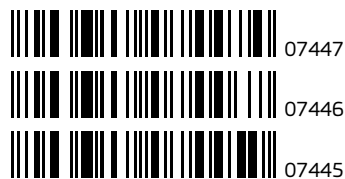

ΑΛΦΑΔΟΛΑΣΤΙΧΟ

Barcode	Icon	Quantity
07447	No 8	50 m
07446	No 10	50 m
07445	No 12	50 m

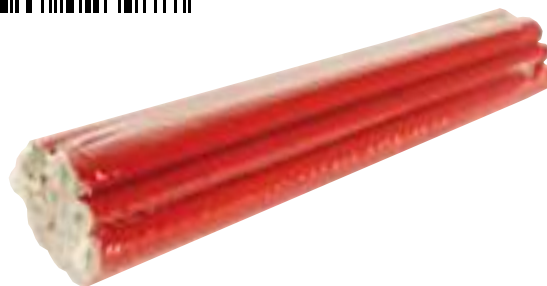

ΜΟΛΥΒΙ ΜΑΡΜΑΡΑΔΩΝ

Barcode	Icon	Quantity
02397	μόνochrome	144



ΠΗΧΗΣ ΑΠΛΟΣ ΑΛΟΥΜΙΝΙΟΥ 8x20 cm

Barcode	Icon	Quantity
01238	μήκος 1,0 m	5
02388	μήκος 1,2 m	5
02875	μήκος 1,5 m	5
01587	μήκος 1,8 m	5
00848	μήκος 2,0 m	5
00849	μήκος 2,5 m	5
02515	μήκος 3,0 m	5
02036	μήκος 3,5 m	5
02314	μήκος 4,0 m	5
01549	μήκος 5,0 m	5

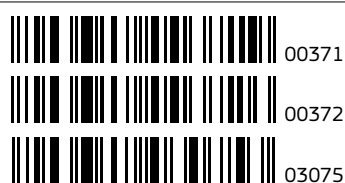

ΖΥΓΙ ΜΑΡΑΓΚΩΝ

Barcode	Icon	Quantity
00371	400 gr	2
00372	500 gr	2
03075	600 gr	2



BELLOTA



ΝΗΜΑ ΣΤΑΘΜΗΣ 50222

05252	113 gr - 30 m	6



00366



00367



00368



00369



ΖΥΓΙ ΟΙΚΟΔΟΜΩΝ

00366	No 1 - 400 gr	3
00367	No 2 - 550 gr	2
00368	No 3 - 850 gr	2
00369	No 4 - 1300 gr	1



INTER



ΠΑΧΥΜΕΤΡΟ ΣΕ ΠΛΑΣΤΙΚΗ ΚΑΖΕΤΙΝΑ

01448	4 χρήσεων - 150 mm	2



13508



13509

INTER



ΜΙΚΡΟΜΕΤΡΟ ΕΞΩΤΕΡΙΚΟ

13508	0-25 mm	1
13509	25-50 mm	1



01761



01762



01763

VOLA



ΦΑΛΤΣΟΓΩΝΙΑ

01761	μήκος 300 mm	6
01762	μήκος 400 mm	6
01763	μήκος 500 mm	6



INTER

BLISTER



ΠΑΧΥΜΕΤΡΟ ΠΛΑΣΤΙΚΟ ΣΕΤ 2 ΤΜΧ

13507	80 mm + 150 mm	10

ΟΡΓΑΝΑ ΜΕΤΡΗΣΗΣ



02247
00253



ΓΩΝΙΑ ΚΤΙΣΤΩΝ

02247	400x230 mm	1
00253	500x280 mm	1



14072
14073

KDS

ΜΕΤΡΟ ΡΟΛΟ 25mm

14072	5,5 m	4
14073	7,5 m	4



01047

ΜΕΤΡΟ ΡΟΛΟ 2 m

01047	174	12
-------	-----	----



14074

KDS

ΜΕΤΡΟ ΡΟΛΟ 25 mm

14074	5 m	4
-------	-----	---



13541
13542

KDS

ΜΕΤΡΟ ΡΟΛΟ 19 mm

13541	3,5 m	6
13542	5,5 m	6



14075

KDS

ΜΕΤΡΟ ΡΟΛΟ 25 mm

14075	8 m	4
-------	-----	---



13543
13544

KDS

ΜΕΤΡΟ ΡΟΛΟ 25 mm

13543	5,5 m	4
13544	7,5 m	4



04905

ΜΕΤΡΟ ΣΠΑΣΤΟ ΞΥΛΙΝΟ ΠΑΛΑΜΗΣ

04905	1 m	12
-------	-----	----



INTER



ΜΕΤΡΟ ΣΠΑΣΤΟ ΞΥΛΙΝΟ ΠΟΛΥΧΡΩΜΟ

06514	2 m	10



STABILA

**HOT
SELLER**



ΜΕΤΡΟ ΣΠΑΣΤΟ ΞΥΛΙΝΟ

03158	2 m	10

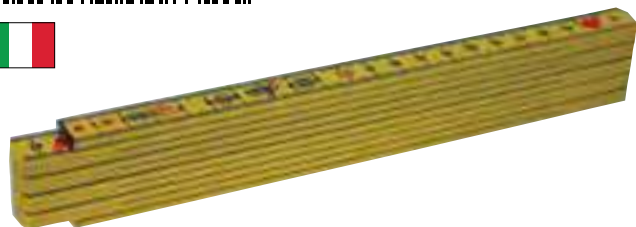

ΜΕΤΡΟ ΣΠΑΣΤΟ ΠΛΑΣΤΙΚΟ

01684	2 m	12



12344



12345

BELLOTA



ΜΕΤΡΟΤΑΙΝΙΑ 50021

12344	50021-30	1
12345	50021-50	1



10269



10271



10270



00861

INTER



ΜΕΤΡΟΤΑΙΝΙΑ

10269	20 m	2
10270	25 m	2
10271	30 m	2
00861	50 m	2



COOPER Tools



ΤΡΟΧΟΣ ΜΕΤΡΗΣΗΣ ΑΠΟΣΤΑΣΕΩΝ

07688	Φ 320 mm - 10 km	1

ΜΠΟΥΛΟΝΟΚΟΦΤΕΣ - ΤΑΝΑΛΙΕΣ



ΜΠΟΥΛΟΝΟΚΟΦΤΗΣ ΤΑΪΒΑΝ

02698 μήκος 450 mm - 18" 2



NEW
ARRIVAL

ΤΑΝΑΛΑΚΙ ΜΠΕΤΟΥ ΜΕ ΜΟΝΩΣΗ

03491 μήκος 180 mm 6



ΜΠΟΥΛΟΝΟΚΟΦΤΗΣ ΓΙΑ ΠΛΕΓΜΑΤΑ ΤΑΪΒΑΝ

03619 μήκος 200 mm - 8" 10



NEW
ARRIVAL

ΤΑΝΑΛΑΚΙ ΜΠΕΤΟΥ (ΜΑΥΡΟ)

06711 μήκος 180 mm 6



ΤΑΝΑΛΑΚΙ ΜΠΕΤΟΥ ΜΕ ΜΟΝΩΣΗ 2622

03490 μήκος 160 mm 6



04105



04106

INTER



BLISTER

GET IT NOW

ΤΑΝΑΛΑΚΙ ΜΠΕΤΟΥ

04105 μήκος 160 mm 6
04106 μήκος 180 mm 6

**ΤΑΝΑΛΑΚΙ ΜΕ ΜΟΝΩΣΗ**

01607



μήκος 160 mm



6



BLISTER

ΚΛΕΙΔΙ ΝΙΠΗΡΟΣ

02214



μήκος 280 mm - 11"



10

**ΤΑΝΑΛΙΑ ΠΛΑΚΙΔΙΩΝ 5203**

01263



μήκος 200 mm



6

NEW
ARRIVAL**ΚΛΕΙΔΙ ΡΟΛΟΓΙΩΝ ΥΔΡΕΥΣΗΣ ΟΥΛΕΝ**

14302



1

**ΠΟΛΥΚΛΕΙΔΟ ΤΑΪΒΑΝ**

01465



μήκος 250 mm - 10"



5

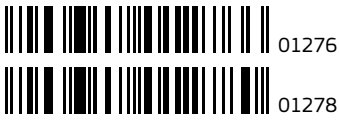

ΣΤΙΛΣΟΝ ΕΛΑΤΗΡΙΟΥ

Barcode	Icon	Quantity
01276	μῆκος 8"	6
01278	μῆκος 12"	6



BLISTER

GET IT NOW

ΣΤΙΛΣΟΝ ΕΛΑΤΗΡΙΟΥ

Barcode	Icon	Quantity
03803	μῆκος 10"	40
01631	μῆκος 12"	30
02914	μῆκος 14"	20
02571	μῆκος 18"	16
01281	μῆκος 24"	8
01512	μῆκος 36"	4

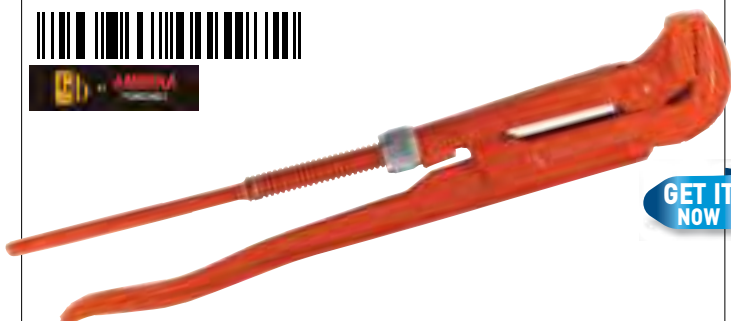

GET IT NOW

ΤΣΙΜΠΙΔΑ ΥΔΡΑΥΛΙΚΩΝ 90°

Barcode	Icon	Quantity
01597	Φ 1½"	4

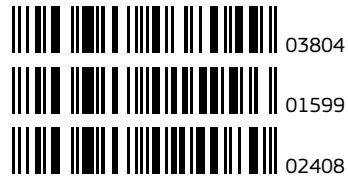

BLISTER

GET IT NOW

ΤΣΙΜΠΙΔΑ ΥΔΡΑΥΛΙΚΩΝ 45°

Barcode	Icon	Quantity
03804	Φ 3/4"	4
01599	Φ 1"	4
02408	Φ 1½"	2

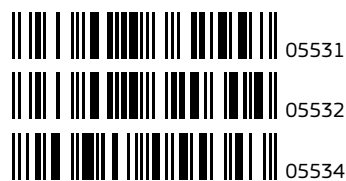

ΣΠΙΡΑΛ ΥΔΡΑΥΛΙΚΩΝ

Barcode	Icon	Quantity
05531	μῆκος 250 mm	10
05532	μῆκος 300 mm	10
05534	μῆκος 500 mm	10



ΑΝΤΛΙΑ ΥΓΡΩΝ ΔΡΑΠΑΝΟΥ ΤΑΪΒΑΝ

07290		12



08859



08821



ΜΟΛΥΒΔΟΦΥΛΛΟ ΡΟΛΛΟ

08859	μήκος x πλάτος 5x0,5 m	Kg
08821	μήκος x πλάτος 5x1,0 m	Kg



05568



05182



ΑΝΤΛΙΑ 12V ΤΑΪΒΑΝ

05568	600 γαλόνια ανά ώρα - Φ 3/4"	1
05182	1400 γαλόνια ανά ώρα - Φ 1"	1

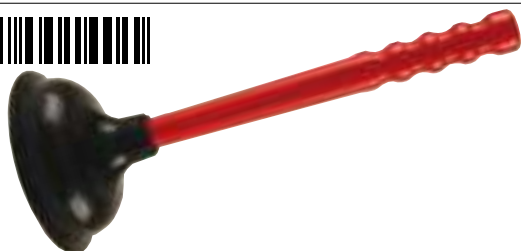

ΑΠΟΦΡΑΚΤΗΡΑΣ

00140	μεγάλος	12



02781



02292



02782



01731



ΑΤΣΑΛΙΝΑ ΥΔΡΑΥΛΙΚΩΝ ΣΠΙΡΑΛ

02781	μήκος 3 m - Φ 5 mm	5
02292	μήκος 5 m - Φ 9 mm	5
02782	μήκος 10 m - Φ 9 mm	2
01731	μήκος 15 m - Φ 9 mm	1



05526



07879



INTER



ΣΠΙΡΑΛ ΝΤΟΥΣ

05526	μήκος 1,5 m	10
07879	μήκος 2 m	10



INTER



ΤΗΛΕΦΩΝΟ ΝΤΟΥΣ

06221	code 8GL2021SB	10



INTER

BLISTER

ΦΙΛΤΡΟ ΝΕΡΟΥ ΓΙΑ ΒΡΥΣΗ

09343		50
-------	--	----



ΦΥΛΛΟΣΥΛΛΕΚΤΗΣ ΠΛΑΣΤΙΚΟΣ

15663 Φυλλοπροστασία για σωλήνες Φ 80mm έως 140mm 5



INTER

09333
09334
09332

BLISTER

ΣΧΑΡΑΚΙ ΣΙΦΩΝΙΟΥ ΖΑΜΑΚ

09333	Φ 100 mm	10
09334	Φ 120 mm	10
09332	120x120 mm	10



INTER

BLISTER

ΠΡΟΕΚΤΑΣΗ ΒΡΥΣΗΣ ΓΙΑ ΝΕΡΟ

09344	εύκαμπτη	25
-------	----------	----



INTER

09329
09330
09331

BLISTER

ΣΧΑΡΑΚΙ ΣΙΦΩΝΙΟΥ ΙΝΟΧ

09329	Φ 100 mm	20
09330	Φ 120 mm	20
09331	120x120 mm	20



06229 06227

ΒΡΥΣΗ ΔΙΑΚΟΣΜΗΤΙΚΗ

06229	άλογο	2
06227	πουλί	2



ΚΑΝΟΥΛΑ ΣΦΑΙΡΙΚΗ

Barcode	Icon	Unit
06266	Φ 1/2" B.T.	20
10127	Φ 1/2" E.T.	14
00515	Φ 3/4" B.T.	12
06074	Φ 1" B.T.	8

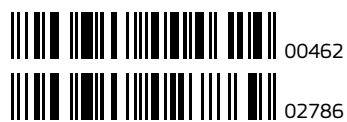

ΚΑΝΟΥΛΑ ΚΡΑΣΙΟΥ ΣΙΔΕΡΕΝΙΑ

Barcode	Icon	Unit
00462	Φ 1,2" x 14 cm μήκος	5
02786	Φ 1,2" x 16 cm μήκος	5

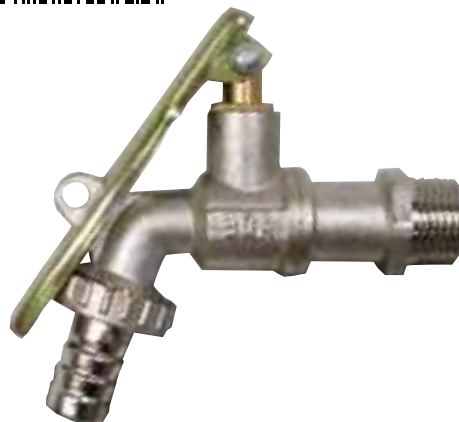

ΚΑΝΟΥΛΑ ΣΦΑΙΡΙΚΗ ΓΙΑ ΛΟΥΚΕΤΟ

Barcode	Icon	Unit
04505	Φ 1/2"	12

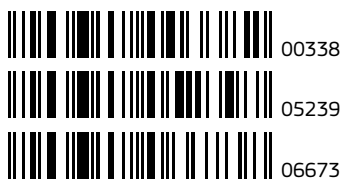

ΔΙΑΚΟΠΤΗΣ ΝΕΡΟΥ ΣΦΑΙΡΙΚΟΣ

Barcode	Icon	Unit
00338	Φ 1/2" E.T.	20
05239	Φ 3/4" E.T.	16
06673	Φ 1" B.T.	8

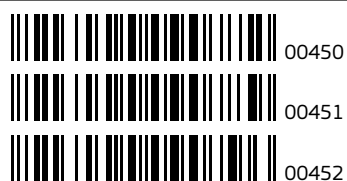

ΚΑΝΟΥΛΑ ΚΡΑΣΙΟΥ ΠΛΑΣΤΙΚΗ

Barcode	Icon	Unit
00450	A	12
00451	B	12
00452	Γ	12





ΚΑΝΟΥΛΑ ΓΙΑ ΒΑΡΕΛΙΑ

		
04224	Φ 1/2"	5





ΚΑΝΟΥΛΑ ΛΑΔΙΟΥ ΓΙΑ ΤΕΝΕΚΕ

		
09378	για 5/10/17 lt	12

GET IT NOW





ΚΑΝΟΥΛΑ ΠΕΤΡΕΛΑΙΟΥ ΠΑΛΑΙΟΥ ΤΥΠΟΥ

		
00458	Φ 3/4"	12





ΚΑΝΟΥΛΑ ΠΕΤΡΕΛΑΙΟΥ ΧΩΡΙΣ ΔΙΑΦΡΑΓΜΑ ΑΝΑΡΡΟΦΗΤΗΡΑ

		
00531	Φ 3/4" βήμα ΑΠΚΟ	12





ΚΑΝΟΥΛΑ ΠΕΤΡΕΛΑΙΟΥ ΝΕΟΥ ΤΥΠΟΥ

		
00459	Φ 3/4"	12









01198
02325



ΡΑΚΟΡ ΜΕΤΑΛΛΙΚΟ ΘΗΛΥΚΟ ΙΤΑΛΙΑΣ

		
01198	Φ 1/2"	10
02325	Φ 3/4"	10

01965
02023

ΠΥΡΑΦΙ

		
01965	ορείχάλκινο	10
02023	πλαστικό	50



ΣΤΗΡΙΓΜΑ ΩΜΕΓΑ ΣΩΛΗΝΩΝ

Barcode	Icon	Quantity
14981	Φ 18"	500
09156	Φ 22"	500
09157	Φ 28"	500
09158	Φ 32"	500



ΣΤΗΡΙΓΜΑ ΠΛΑΣΤΙΚΩΝ ΣΩΛΗΝΩΝ

Barcode	Icon	Quantity
02699	Φ 50 mm	50
02700	Φ 63 mm	50
02701	Φ 75 mm	50
02815	Φ 100 mm	50
02816	Φ 125 mm	40
01475	Φ 150 mm	50



ΣΤΗΡΙΓΜΑ ΣΙΔΗΡΟΣΩΛΗΝΩΝ ΜΟΝΟ

Barcode	Icon	Quantity
05345	Φ 1/2"	50
05346	Φ 3/4"	50
05347	Φ 1"	50
05426	Φ 1 1/4"	50
06451	1 1/2"	50
06562	Φ 2" B.T.	10
06563	Φ 2 1/2" B.T.	10

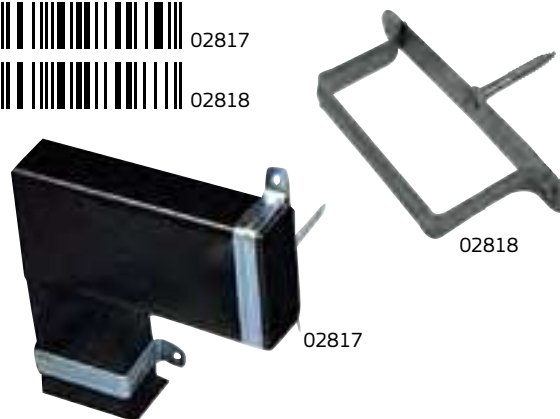

ΣΤΗΡΙΓΜΑ ΣΩΛΗΝΑ ΥΔΡΟΡΟΗΣ 6x10 cm

Barcode	Icon	Quantity
02817	απλό	20
02818	με στριφώνι	50



ΣΤΗΡΙΓΜΑ ΥΔΡΟΡΟΗΣ ΛΑΜΑΚΙ

Barcode	Icon	Quantity
08481	σετ 80 τμχ.	1



ΣΤΗΡΙΓΜΑ ΥΔΡΟΡΟΗΣ ΝΕΟΥ ΤΥΠΟΥ

Barcode	Icon	Quantity
04567	ανοικτό	50



02103



04908



09676



ΣΤΗΡΙΓΜΑ ΥΔΡΟΡΗΣ

Barcode	Description	Quantity
02103	σετ	100
04908	μόνο γάντζος	150
09676	εσωτερικό πλαϊνό	150



02171



02172



01785



ΤΣΕΡΚΙ ΣΤΕΡΕΩΣΗΣ 10 m

Barcode	Description	Quantity
02171	12x0,7 mm (πλάτος x πάχος)	30
02172	17x0,8 mm (πλάτος x πάχος)	50
01785	26x1,0 mm (πλάτος x πάχος)	10

GET IT NOW

HOT SELLER



05857



03194



ΤΣΕΡΚΙ ΙΝΟΧ 30,5 m ΤΑΪΒΑΝ

Barcode	Description	Quantity
05857	9,5x0,4 mm (πλάτος x πάχος)	1
03194	16x0,4 mm (πλάτος x πάχος)	1



04485



05288



05280



ΚΛΙΠΣ ΙΝΟΧ ΓΙΑ ΤΣΕΡΚΙ ΤΑΪΒΑΝ

Barcode	Description	Quantity
04485	3/8" - (10 mm)	100
05288	1/2" - (12,7 mm)	100
05280	5/8" - (16 mm)	100

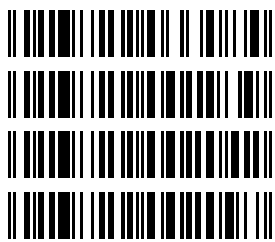

01274

01458

12054

04036



IDEALGAS C. & C. Snc



BLISTER

ΦΛΟΓΙΣΤΡΟ ΜΕ ΣΚΑΝΔΑΛΗ

Barcode	Icon	Code	Quantity
01274		code FCL 105/20	1
01458		code FCL 105/50	1
12054		code FCL 115/76	1
04036		code FCL 216/60	1



IDEALGAS C. & C. Snc



BLISTER

ΦΛΟΓΙΣΤΡΟ ΜΕ ΛΑΣΤΙΧΟ 1,5 m FKL108

Barcode	Icon	Code	Quantity
02496		3 υποδοχών	1



IDEALGAS C. & C. Snc

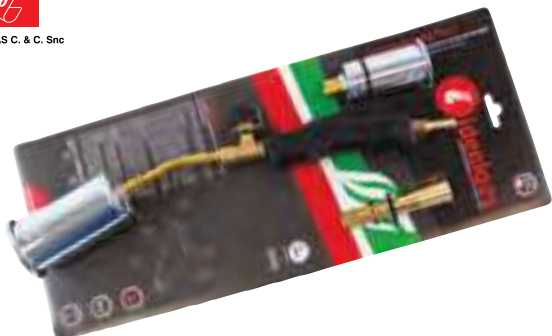

BLISTER

ΦΛΟΓΙΣΤΡΟ FC108

Barcode	Icon	Code	Quantity
03810		3 υποδοχών	1



BLISTER



ΦΛΟΓΙΣΤΡΟ ΤΑΪΒΑΝ ΓΙΑ ΦΙΑΛΗ MAP GAS

Barcode	Icon	Code	Quantity
05821		περιστρεφόμενο	8



IDEALGAS C. & C. Snc



BLISTER

ΦΛΟΓΙΣΤΡΟ ΓΙΑ ΦΙΑΛΗ MAP GAS

Barcode	Icon	Code	Quantity
03207		σταθερό	1

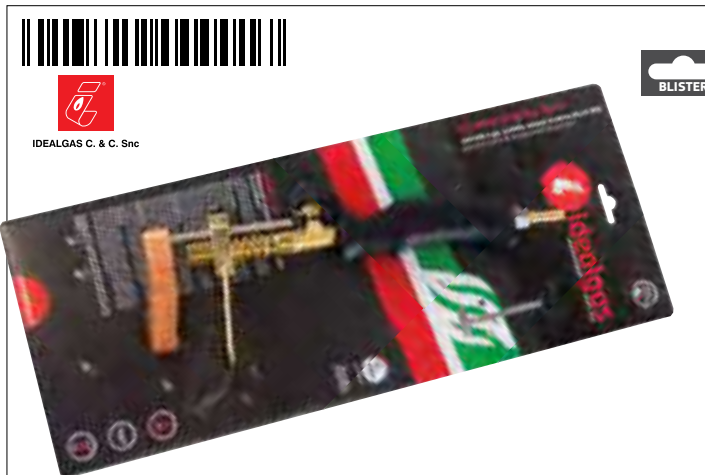

IDEALGAS C. & C. Snc

ΚΟΛΗΤΗΡΙΑ ΓΚΑΖΙΟΥ

02556	code FC 101	1
-------	-------------	---



02400
04933

04933 02400

ΚΟΛΗΤΗΡΙΑ ΑΝΤΑΛΛΑΚΤΙΚΟ

02400	200 gr - Ιταλίας	1
04933	700 gr - Γερμανίας	1



02062
08099

IDEALGAS C. & C. Snc

ΚΟΛΗΤΗΡΙΑ ΓΚΑΖΙΟΥ ΜΕ ΜΕΤΑΛΛΙΚΗ ΒΑΣΗ

02062	απλό	1
08099	αυτόματο	1



00311
01747

IDEALGAS C. & C. Snc

ΡΥΘΜΙΣΤΗΣ ΠΕΤΡΟΓΚΑΖ

00311	υψηλής πίεσης	5
01747	χαμηλής πίεσης	5



IDEALGAS C. & C. Snc

ΚΟΛΗΤΗΡΙΑ ΓΚΑΖΙΟΥ ΜΕ ΠΛΑΣΤΙΚΗ ΒΑΣΗ

00488		1
-------	--	---



02587
07972

IDEALGAS C. & C. Snc

ΓΚΑΖΑΚΙΑ ΚΑΦΕ

02587	απλό, μεταλλικό	1
07972	αυτόματο, πλαστικό	1



ΠΕΤΡΟΓΚΑΖ ΜΕ 3 ΠΟΔΙΑ

09720	για τσίπουρο	1
-------	--------------	---



ΠΕΤΡΟΓΚΑΖ ΜΕ 4 ΠΟΔΙΑ

09721	για τσίπουρο	1
-------	--------------	---



ΠΕΤΡΟΓΚΑΖ ΛΕΥΚΟ

09798	με 2 μάτια	1
09799	με 3 μάτια	1



ΠΕΤΡΟΓΚΑΖ ΕΜΑΓΙΕ ΚΑΦΕ

10681	1 μάτι	1
10683	1+½ μάτια	1
10684	2 μάτια	1
10685	2 μάτια φαρδύ	1
10686	2+½ μάτια	1

HOT SELLER



ΚΛΕΙΔΙ ΠΕΤΡΟΓΚΑΖ

00533		5
-------	--	---

BLISTER GET IT NOW



ΡΑΚΟΡ ΠΕΤΡΟΓΚΑΖ ΜΕ ΔΙΑΚΟΠΤΗ



10691



στραγκαλιστής



5



ΡΑΚΟΡ ΠΕΤΡΟΓΚΑΖ



10688



10



ΣΩΛΗΝΑΚΙ ΠΕΤΡΟΓΚΑΖ



10689



5



ΜΠΕΚ ΠΕΤΡΟΓΚΑΖ



10880



A'



10



10687



10988



10690



ΚΕΦΑΛΗ ΠΕΤΡΟΓΚΑΖ



10687



μεγάλη



10

10988

μικρή

5

10690

μικρή μπρούτζινη

5



10989



10990



10990

ΔΙΑΚΟΠΤΗΣ ΠΕΤΡΟΓΚΑΖ



10989



(T)



5

10990

(+)

5



Generator compatibility Protac 400 Technology

Συμβατές με γεννήτριες, Προστασία υπέρτασης ως 400V

ΚΩΔ: 12869 INVERTER 3200 με πλαστική βαλίτσα

		I₂ MMA (A)			X₂ (20°C)	EM80074-1 (40°C)	U_i		
Stick	MMA	10 + 130	0,6 0,8 0,2 0,2 0,2 0,4	10 10 10 10 10 10	10 10 10 10 10 10	10 10 10 10 10 10	10 10 10 10 10 10	10 10 10 10 10 10	
230V	13A	10 + 130	0,2 0,2 0,2 0,2 0,2 0,2	10 10 10 10 10 10	10 10 10 10 10 10	10 10 10 10 10 10	10 10 10 10 10 10	10 10 10 10 10 10	



ΚΩΔ: 12870 INVERTER 3200
με ηλεκτρονική μάσκα κεφαλής Flip-Flap



ΚΩΔ: 12871 INVERTER 3200
με ηλεκτρονική μάσκα κεφαλής LCD11

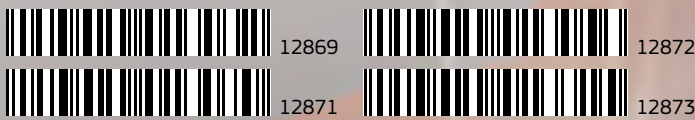

ΚΩΔ: 12872 INVERTER 4000 με πλαστική βαλίτσα

		I₂ MMA (A)			X₂ (20°C)	EM80074-1 (40°C)	U_i		
Stick	MMA	10 + 160	0,6 0,8 0,2 0,2 0,2 0,4	10 10 10 10 10 10	10 10 10 10 10 10	10 10 10 10 10 10	10 10 10 10 10 10	10 10 10 10 10 10	
230V	16A	10 + 160	0,2 0,2 0,2 0,2 0,2 0,2	10 10 10 10 10 10	10 10 10 10 10 10	10 10 10 10 10 10	10 10 10 10 10 10	10 10 10 10 10 10	



Generator compatibility Protac 400 Technology

Συμβατές με γεννήτριες, Προστασία υπέρτασης ως 400V

ΚΩΔ: 12873 INVERTER 4000
με ηλεκτρονική μάσκα κεφαλής LCD11



ΗΛΕΚΤΡΟΣΥΓΚΟΛΛΗΣΗ



Πάνελ με ψηφιακή ρύθμιση ακριβείας
Καλύτερη ποιότητα συγκόλλησης με TIG

Generator compatibility



Prottec 400 Technology



Συμβατές με γεννήτριες, Προστασία υπέρτασης ως 400V



ΚΩΔ: 12874 INVERTER 5000 με πλαστική βαλίτσα

50/60Hz	MMA	I ₂ MMA (A)	1h φ1,6 φ2 φ2,5 φ3,2 φ4	MIG 20°	X% (20°C)	EN60974-1 (40°C) IA (90%) X% (12 max)	U ₀	Cm	Kg	Protected & compatible Power generator (+/- 15%)
230v	16A	10 → 160	62 50 47 45 23	65% @ 160A	90A 19%	72V	12x21x27	4,6	6 Kw - 7,5 Kva	

200Α Επαγγελματικών προδιαγραφών
Εύκολος χειρισμός
Κατάλληλη για τη συγκόλληση μετάλλων
πάχους απο 1,5 έως και 10mm



ΚΩΔ: 12875 INVERTER 6000 με πλαστική βαλίτσα

50/60Hz	MMA	I ₂ MMA (A)	1h φ1,6 φ2 φ2,5 φ3,2 φ4 φ5	MIG 20°	X% (20°C)	EN60974-1 (40°C) IA (90%) X% (12 max)	U ₀	Cm	Kg	Protected & compatible Power generator (+/- 15%)
230v	32A	10 → 200	62 50 47 45 30 21	58% @ 200A	120A 16%	83V	27x18x14	5	7 Kw - 10 Kva	



ΚΩΔ: 12878 LCD TECHNO 11
Ηλεκτρονική μάσκα κεφαλής



ΚΩΔ: 12879 LCD TECHNO 9-13
Ηλεκτρονική μάσκα κεφαλής



Ελαφριά και Συμπαγής
Εύκολος χειρισμός - Γρήγορη εκκίνηση
Gas / No Gas
Δέχεται μπομπίνα Φ100mm



Μοτέρ επαγγελματικών προδιαγραφών

ΚΩΔ: 12876 MULTIMIG 140

50/60Hz	MMA I ²	mm		100	Electronic Control	EN60974-1 (40°C)		cm/kg	✓		
		GAS	NO GAS			I _A (80%)	X% (2 max)				
230V	16A	105-140A	0,6 - 0,8	✓	0,8 - 0,9	0,8	80A	140A 15%	70A 15%	38x16x35 / 7,8	4,5 kW



Ελαφριά και Συμπαγής
Εύκολος χειρισμός - Γρήγορη εκκίνηση
Gas / No Gas
Δέχεται μπομπίνα Φ100 / 200mm
Ευέλικτη με 2 περιστρεφόμενες ρόδες
Θέση για την μπουκάλα αερίου



ΚΩΔ: 12877 NOVOMIG 160 (no regulator)

50/60Hz	MMA I ²	mm			Electronic Control	EN60974-1 (40°C)		cm/kg	✓				
		GAS	NO GAS	100 200 300		I _A (80%)	X% (2 max)						
230V	16A	30-160A	0,6 - 1,0	0,9 - 1,2	✓	✓	-	0,6 - 0,8	0,8	70A	115A 20%	34x54x45 / 25	4,5 kVA



ΕΚΘΕΤΗΡΙΟ ΗΛΕΚΤΡΟΣΥΓΚΟΛΛΗΣΕΩΝ

14017	code 060784	1





ΜΑΓΝΗΤΗΣ ΗΛΕΚΤΡΟΣΥΓΚΟΛΛΗΤΩΝ ΣΕΤ 4 τμχ.

13958 code P16.90 044180 1



ΜΑΓΝΗΤΗΣ ΗΛΕΚΤΡΟΣΥΓΚΟΛΛΗΤΩΝ

13959 code P19.90 044203 1



ΜΑΓΝΗΤΗΣ ΔΙΠΛΟΣ ΗΛΕΚΤΡΟΣΥΓΚΟΛΛΗΤΩΝ

13960 code P20.180 044302 1



ΜΑΓΝΗΤΗΣ ΔΙΠΛΟΣ ΗΛΕΚΤΡΟΣΥΓΚΟΛΛΗΤΩΝ ΜΕ ΔΙΑΚΟΠΤΗ

13961 code D50.90 DUAL 047051 1



ΣΦΥΡΙ ΗΛΕΚΤΡΟΣΥΓΚΟΛΛΗΤΩΝ

13955 code 044159 - βάρος 240 gr 1



ΣΦΥΡΙ ΗΛΕΚΤΡΟΣΥΓΚΟΛΛΗΤΩΝ

13956 code 044128 - βάρος 425 gr 1

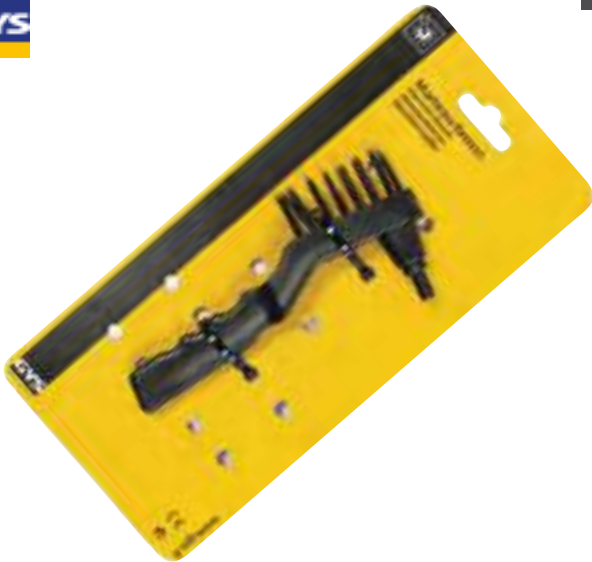

ΣΦΥΡΙ-ΣΥΡΜΑΤΟΒΟΥΡΤΣΑ ΗΛΕΚΤΡΟΣΥΓΚΟΛΛΗΤΩΝ

Barcode	Code	Quantity
13957	code 044166	1



13928



13929



13930



ΤΣΙΜΠΙΔΑ ΗΛΕΚΤΡΟΣΥΓΚΟΛΛΗΤΩΝ

Barcode	Code	Quantity
13928	code 043602 - AMP 200	1
13929	code 043701 - AMP 300	1
13930	code 043718 - AMP 500	1



13931



13932



13933



ΤΣΙΜΠΙΔΑ ΗΛΕΚΤΡΟΣΥΓΚΟΛΛΗΤΩΝ ΜΕ ΚΑΛΩΔΙΟ

Barcode	Code	Quantity
13931	code 043855 - AMP 200	1
13932	code 043862 - AMP 300	1
13933	code 043879 - AMP 500	1



13934



13935



13936



ΣΩΜΑ ΓΕΙΩΣΗΣ ΗΛΕΚΤΡΟΣΥΓΚΟΛΛΗΤΩΝ

Barcode	Code	Quantity
13934	code 043107 - AMP 200	1
13935	code 043206 - AMP 400	1
13936	code 038042 - AMP 600	1





ΣΩΜΑ ΓΕΙΩΣΗΣ ΟΡΕΙΧΑΛΚΙΝΟ ΜΕ ΒΙΔΑ

13950 code 043176 - AMP 400 1





ΣΩΜΑ ΓΕΙΩΣΗΣ ΟΡΕΙΧΑΛΚΙΝΟ VICE GRIP

13951 code 043220 - AMP 600 1





ΣΩΜΑ ΓΕΙΩΣΗΣ ΜΕ ΚΑΛΩΔΙΟ 2 m

13952 code 043770 - AMP 200 1





ΣΩΜΑ ΓΕΙΩΣΗΣ ΟΡΕΙΧΑΛΚΙΝΟ ΜΕ ΒΙΔΑ ΜΕ ΚΑΛΩΔΙΟ 4 m

13954 code 043800 - AMP 400 1









ΣΩΜΑ ΓΕΙΩΣΗΣ ΟΡΕΙΧΑΛΚΙΝΟ VICE GRIP ΜΕ ΚΑΛΩΔΙΟ 4 m

13953 code 043831 - AMP 600 1

ΠΡΟΒΟΛΕΑΣ LED ΜΕ ΠΤΥΣΣΟΜΕΝΟ ΤΡΙΠΟΔΟ

13988 code 059146 - ισχύς 22 W /1800 Lm 1





ΓΑΝΤΙΑ ΗΛΕΚΤΡΟΣΥΓΚΟΛΛΗΤΩΝ

13984 code 045101 1





ΕΝΙΣΧΥΜΕΝΑ ΓΑΝΤΙΑ ΗΛΕΚΤΡΟΣΥΓΚΟΛΛΗΤΩΝ

13985 code 045873 1





BLISTER

ΓΥΑΛΙΑ ΠΡΟΣΤΑΣΙΑΣ IR0

		
13962	code 047792	1





BLISTER

ΓΥΑΛΙΑ ΠΡΟΣΤΑΣΙΑΣ IR5

		
13963	code 042841	1





BLISTER

ΓΥΑΛΙΑ ΟΞΥΓΟΝΟΥ IR5

		
13964	code 042803	1





BLISTER

**ΓΥΑΛΙΑ ΠΡΟΣΤΑΣΙΑΣ IR5
ΓΙΑ ΣΥΓΚΟΛΛΗΣΗ ΜΕ ΦΛΟΓΙΣΤΡΟ**

		
13965	code 042858	1







BLISTER



ΠΟΔΙΑ ΔΕΡΜΑΤΙΝΗ ΠΟΛΛΑΠΛΩΝ ΧΡΗΣΕΩΝ

		
13986	code 045200	1

BLISTER

**ΠΟΔΙΑ ΕΠΑΓΓΕΛΜΑΤΙΚΗ
ΗΛΕΚΤΡΟΣΥΓΚΟΛΛΗΤΩΝ**

		
13987	code 045217	1



ΜΑΣΚΑ ΗΛΕΚΤΡΟΣΥΓΚΟΛΛΗΤΩΝ ΚΕΦΑΛΗΣ ΤΑΪΒΑΝ



03789	μάσκα	5



00887



02042



ΜΑΣΚΑ ΗΛΕΚΤΡΟΣΥΓΚΟΛΛΗΤΩΝ

00887	μάσκα	6
02042	τζάμι 9x11 cm DIN11	50



01705



01598



ΤΣΙΜΠΙΔΑ ΗΛΕΚΤΡΟΣΥΓΚΟΛΛΗΤΩΝ

01705	300A	1
01598	500A	1



Παραδίδεται χωρίς τζάμι



ΜΑΣΚΑ ΗΛΕΚΤΡΟΣΥΓΚΟΛΛΗΤΩΝ

08229	ΠΡΕΣΠΑΝ	5



02518



02519



ΤΣΙΜΠΙΔΑ ΗΛΕΚΤΡΟΣΥΓΚΟΛΛΗΤΩΝ

02518	400A	1
02519	600A	1



ΠΟΔΙΑ ΗΛΕΚΤΡΟΣΥΓΚΟΛΛΗΤΩΝ

05640		5



ΣΩΜΑ ΓΕΙΩΣΗΣ ΗΛΕΚΤΡΟΣΥΓΚΟΛΛΗΤΩΝ ΒΑΡΕΩΣ ΤΥΠΟΥ

03829	400A	5



ΗΛΕΚΤΡΟΔΙΑ FINCORD-M ΓΕΝΙΚΗΣ ΧΡΗΣΗΣ

Barcode	Thickness	Weight
01792	2,00 mm	21kg
00379	2,50 mm	24kg
00380	3,25 mm	24kg
01483	4,00 mm	24kg

FINCORD - M

Ηλεκτρόδιο μέσης επένδυσης τύπου ρουτιλίου, ιδιαίτερα κατάλληλο για κολλήσεις λεπτών ελασμάτων.

Για συνεχείς ραφές το Fincord-M μπορεί να κρατιέται σε επαφή με το αντικείμενο χωρίς κίνδυνο κυρτότητας του κορδονιού.

Αυτόματη έναυση και επανέναυση. Ελάχιστο πιστόλισμα.

Στρωτή εμφάνιση ραφής.

Υλικά Εφαρμογών

Μη κεκραμμένοι χάλυβες κατασκευών St 33, St 37, St 44, St 52-3.

Ελάσματα λεβήτων H I, H II.

Χάλυβες σωλήνων St 35, St 35.4, St 35-8, St 45, St 45.4, St 45.8, St 52, St 52.4.

Ναυπηγικοί χάλυβες A, B.

Χυτοχάλυβες GS 38, GS 45.

Λεπτά ελάσματα κατά DIN 1623 p. 1.

Θέσεις συγκόλλησης: Οριζόντια, ανεβατό, ουρανός.

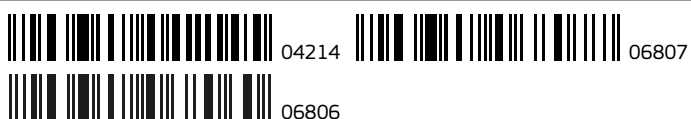

ΗΛΕΚΤΡΟΔΙΑ ΧΑΛΥΒΑ SUPERCITO

Barcode	Thickness	Weight
04214	2,50 mm	18kg
06806	3,25 mm	27kg
06807	4,00 mm	27kg

SUPERCITO

Ηλεκτρόδιο βασικού τύπου με απόδοση 115%. Κατάλληλο για συνεκτικές συνδέσεις μεγάλης αντοχής σε ρηγματώσεις, ακόμα και χάλυβων με άνθρακα μέχρι 0,4 %. Καλά χαρακτηριστικά συγκόλλησης σε όλες τις θέσεις, εύκολη απομάκρυνση κρούστας.

Υλικά εφαρμογών

Μη κεκραμμένοι χάλυβες κατασκευών St 33, St 37, St 44, St 52-3, St 50-2*, St 60-2*, St70-2*.

Λεπτόκοκκοι χάλυβες κατασκευών St E 255 (St E 26), St E 285 (St E 29), St E 315 (St E 32), St E3 55 (St E 36), W St E 255 (W St 28), W St E 285 (W St En 29), W St E 315 (W St E 32), W St E 355 (W St E 36) W St E 255 (TT St E 29), T St E 315 (TT St E 32), T St E 355 (TT St E 36).

Ελάσματα λεβήτων H I, H II, A St 35, A St 41, A St 45, 17Mn4,19Mn5*.

Χάλυβες σωλήνων St 35, St 35.4, St 35.8, St 45, St 45.4, St 45.8, St 55*, St 55.4*, St 52, St 52.4, St E 210,7 (St 34.7), St E 240,7 (St 38.7) St E 290,7 (St 43.7), St E 320,7 (St 47.7), St E 360,7 (St 53.7).

Ναυπηγικοί χάλυβες A, B, D, E. Χυτοχάλυβες GS-38, GS-45, GS-52.

* Προθέρμανση σε 150-300° C ανάλογα με το πάχος του ελάσματος.

Θέσεις συγκόλλησης : Οριζόντια, ανεβατό, ουρανός.



ΗΛΕΚΤΡΟΔΙΑ ΓΑΛΒΑΝΙΖΕ OVERVORD-S

Barcode	Thickness	Weight
05445	2,50 mm	21kg
14784	3,25 mm	27kg

OVERCORD-S

Ηλεκτρόδιο παχειάς επένδυσης τύπου ρουτιλίου για γενικές εργασίες σιδηρών κατασκευών λεπτών ελασμάτων σιδήρου και χάλυβα, εργασίες καροσερί αυτοκινήτων, κατασκευές λεβήτων, εργασίες λαμαρινοκατασκευών κ.λπ.

Καλή εμφάνιση ραφών χωρίς πιστόλισμα, με αυτόματη έναυση κι επανέναυση. Εύκολη απομάκρυνση κρούστας.

Υλικά Εφαρμογών

Μη κεκραμμένοι χάλυβες κατασκευών St 33, St 37, St 44, St 52-3.

Ελάσματα λεβήτων H I, H II.

Χάλυβες σωλήνων St 35, St 35.4, St 35.8, St 45, St 45.4, St 45.8, St 52, St 52.4.

Ναυπηγικοί χάλυβες A, B, D.

Χυτοχάλυβες GS-38, GS-45, GS-52.

Θέσεις συγκόλλησης : Οριζόντια, ανεβατό, ουρανός.



ΗΛΕΚΤΡΟΔΙΑ INOX BELINOX

Barcode	Thickness	Weight
04305	2,50 mm	18kg
01609	3,25 mm	18kg
10266	4,00 mm	18kg

BELINOX

Ηλεκτρόδιο ρουτιλίου υψηλά κεκραμένο με πολύ χαμηλή περιεκτικότητα άνθρακα για σταθεροποιημένους ή μη χρωμιονικελιούχους χάλυβες του τύπου 18 Cr/8 Ni ανθεκτικούς στην ατμοσφαιρική διάβρωση.

Ανθεκτικό σε καταθρυμματισμό των κόκκων όταν δουλεύεται σε θερμοκρασίες μέχρι 350°C.

Ομαλή συγκόλληση.

Καλή έναυση κι επανέναυση.

Καλή εμφάνιση, λεπτός κυματισμός, λείες συνδέσεις.

Εύκολη απομάκρυνση της κρούστας.

Υλικά εφαρμογών

Όλοι οι χρωμιονικελιούχοι χάλυβες με χαμηλή περιεκτικότητα άνθρακα, όπως επίσης σταθεροποιημένοι χρωμιονικελιούχοι χάλυβες τιτανίου και νιοβίου του τύπου 18 Cr/8 Ni π.χ. υλικά Νο 1.4300, 1.4301, 1.4306, 1.4541, 1.4543, 1.4550 AISI 302, 304, 304 L, 321, 347.

Θέσεις συγκόλλησης : Οριζόντια, ανεβατό, ουρανό.



ΗΛΕΚΤΡΟΔΙΑ ΜΑΝΤΕΜΙΟΥ CITOFONTE MONEL

Barcode	Thickness	Weight
00052	2,50 mm	24kg
00787	3,00 mm	24kg

CITOFONTE MONEL

Ηλεκτρόδιο που αποδίδει αποτιθέμενο μέταλλο με 70% Ni και 30% Cu περίπου, κατάλληλο για την αποκατάσταση σπασμένων ή φθαρμένων τεμαχίων από χυτοσίδηρο.

Κατάλληλο για επισκευή τεμαχίων που έχουν κενά και ελαττώματα χύτευσης.

Έχει σταθερό τόξο με κορδόνι χωρίς ελαττώματα.

Το CITOFONTE MONEL δίνει ραφές χωρίς ρωγμές και πόρους.

Οι τάσεις που μπορεί να περικλείονται στο μέταλλο βάσης ή το αποτιθέμενο μέταλλο μπορούν να μειωθούν με σφυρηλάτηση.

Το αποτιθέμενο μέταλλο είναι επεξεργάσιμο.

Υλικά Εφαρμογών

Χυτοσίδηρος, συνδέσεις φανού χυτοσιδήρου με χάλυβα.

Θέσεις συγκόλλησης : Οριζόντια, ανεβατό, ουρανό.

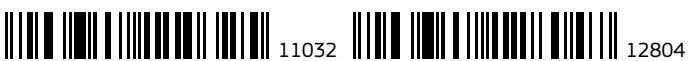

ΗΛΕΚΤΡΟΔΙΑ REX

Barcode	Thickness	Weight
11032	2,50 mm	24kg
12804	3,25 mm	24kg

REX

Ηλεκτρόδιο τύπου ρουτιλίου-κυτταρίνης για εφαρμογές σε κοντινέρες και πιεστικά. Χαμηλής θερμοκρασίας συγκόλλησης και για αυτό κατάλληλο για συναρμολογήσεις λεπτών ελασμάτων.

Ιδιαίτερα κατάλληλο για εξωτερικές γωνιακές ραφές και κορδόνια στο κατεβατό.

Υλικά Εφαρμογών

Μη κεκραμένοι χάλυβες κατασκευών St 33, St 37, St 44, St 52-3.

Ελάσματα λεβήτων H I, H II.

Χάλυβες σωλήνων St 35, St 35.4, St 35.8, St 45, St 45.4, St 45.8, St 52, St 52.4.

Ναυπηγικοί χάλυβες A, B, D.

Χυτοχάλυβες GS-38, GS-45, GS-52.

Θέσεις συγκόλλησης : Οριζόντια, ανεβατό, ουρανό και κατεβατό.



ΗΛΕΚΤΡΟΔΙΑ CITODUR 600A

Barcode	Icon	Icon
08573	3,25 mm	22kg
15614	4,00 mm	22kg

CITODUR 600A

Ηλεκτρόδιο ρουτιλίου για αναγωγώσεις μεγάλης αντοχής στη φθορά. Αποτιθέμενο μέταλλο απαλλαγμένο από ρωγμές και πόρους με ανθεκτικότητα σε φθορές από βαριές κρουστικές εργασίες. Κατεργάζεται μόνο με τρύχισμα. Αναγωγή με μεγάλο αριθμό στρώσεων χωρίς υπόστρωμα είναι δυνατή χωρίς αποκόλληση. Σε ευπαθή ή δύσκολα βασικά μέταλλα χρησιμοποιούμε σαν υπόστρωμα UNIVERS ή CITOCHROMAX-N.

Υλικά εφαρμογών

Κατάλληλο για αναγωγώσεις που υπόκεινται σε συνεχείς τριβές (κουβάδες βυθοκόρων, γεωτρήσιμα, κώνοι, πλάκες θραυστήρων, εκσκαφείς, μεταφορικοί κοχλίες, σιαγώνες, σπαστήρες κ.λπ.).

Θέσεις συγκόλλησης : Οριζόντια, ανεβατό, ουρανός.



ΗΛΕΚΤΡΟΔΙΑ ΑΛΟΥΜΙΝΙΟΥ ALCORD 5 SI F

Barcode	Icon	Icon
04175	2,50 mm	2kg
04923	3,25 mm	2kg

ALCORD 5 SI F

Ηλεκτρόδιο αλουμινίου για συγκολλήσεις καθαρού αλουμινίου και κραμάτων αλουμινίου με περιεκτικότητα <2% κραματούχων στοιχείων. Επίσης, για χυτά κράματα αλουμινίου με περιεκτικότητα <7% σε πυρίτιο.

Υλικά εφαρμογών

Al Si 5, Al Mg Si 0,5, Al Mg Si 0,8, Al Mg Si 1 αλουμίνιο και κράματα αλουμινίου με <2% κραματούχων στοιχείων-χυτά κράματα αλουμινίου <7% Si.

Θέσεις συγκόλλησης : Οριζόντια.



ΗΛΕΚΤΡΟΔΙΑ E6013 ΙΤΑΛΙΑΣ

Barcode	Icon	Icon
11737	2,50 mm	20kg

ΗΛΕΚΤΡΟΔΙΑ ΙΤΑΛΙΑΣ E6013

Ηλεκτρόδιο ανθρακούχου χάλυβα με υψηλή συγκόλληση AC / DC όλων των θέσεων.

Έχει εξαιρετική συγκολλησιμότητα, καλή λειτουργική απόδοση, εύκολη επαναφορά, σταθερό τόξο και όμορφη εμφάνιση συγκόλλησης.

Υλικά εφαρμογών

Χρησιμοποιείται συνήθως σε αυτοκίνητα, πλαίσια φορτηγών, διακοσμητικά σίδερα, μεταλλικά έπιπλα, εφαρμογές γεωργικών εκμεταλλεύσεων, δεξαμενές αποθήκευσης.

Θέσεις συγκόλλησης : Οριζόντια, ανεβατό, ουρανός και κατεβατό.



ΣΥΡΜΑ ΜΗΧΑΝΗΣ ΑΡΓΚΟΝ CARGOFIL 1

Επιαλωμένο μη κραματούχο συμπαγές σύρμα για συγκόλληση υπό ατμόσφαιρα CO₂, κατάλληλο για συνδέσεις μη κραματούχων χαλύβων, για την κατασκευή λεβήτων και συγκολλήσεις σωλήνων αντοχής σε εφελκυσμό μέχρι 510 N/mm².

Υλικά Εφαρμογών

Μη κεκραμένοι χάλυβες κατασκευών St 33, St 37, St 44, St 52- St 50-2* St 60-2*.
Ελάσματα λεβήτων H I, H II, H III, 17Mn4, 19Mn 5*.

Χάλυβες σωλήνων St 35, St 35.4, St 35.8, St 45, St 45.4, St 45.8, St 55*, St 55.4*, St 52, St 52.4, St E 210.7 (St 34.7) St E 240.7 (St 38.7), St E 290.7 (St 43.7), St 320.7 (St 47.7), St E 360.7 (St 53.7).

Ναυπηγικοί χάλυβες A, B, C, D, E.

Χυτοχάλυβες GS-38, GS-45, GS-52.

* Προθέρμανση σε 150-300°C ανάλογα με το πάχος του ελάσματος

ΣΥΡΜΑ ΓΙΑ ΜΗΧΑΝΗ ΑΡΓΟΝ

Barcode	Icon	Weight
15131	0,80 mm	5kg
07519	0,80 mm	15kg
15132	1,00 mm	5kg
07520	1,00 mm	15kg
07521	1,20 mm	15kg

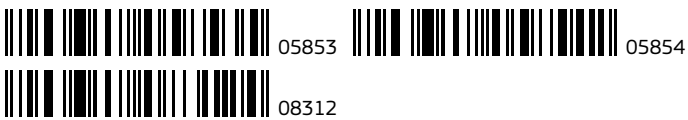

ΟΡΕΙΧΑΛΚΟΚΟΛΛΗΣΗ

Barcode	Icon	Weight
05853	2,00 mm	10kg
08312	3,25 mm	10kg
05854	4,00 mm	10kg



INTER

ΦΟΥΣΚΩΤΗΡΑ ΠΟΔΟΣ ΜΟΝΗ ΝΕΟΥ ΤΥΠΟΥ

		
08087	μήκος εμβόλου 120 cm	10

INTER

ΦΟΥΣΚΩΤΗΡΑ ΠΟΔΗΛΑΤΟΥ ΧΕΙΡΟΣ

		
13058		5

INTER

ΦΟΥΣΚΩΤΗΡΑ ΠΟΔΟΣ ΔΙΠΛΗ ΝΕΟΥ ΤΥΠΟΥ



		
13057	μήκος εμβόλου 110 cm	10

 05825

 05824

ΛΑΣΤΙΧΟ ΓΙΑ ΦΟΥΣΚΩΤΗΡΕΣ ΤΑΪΒΑΝ

		
05825	πόδος	5
05824	χειρός	5

INTER

ΦΟΥΣΚΩΤΗΡΑ ΧΕΙΡΟΣ

		
13059		10



ΦΟΥΣΚΩΤΗΡΑ ΧΕΙΡΟΣ ΤΑΪΒΑΝ

		
03415		5

 05912

 06066

ΦΟΥΣΚΩΤΗΡΑ ΑΡΝΙΩΝ ΜΕΤΑΛΛΟΠΛΑΣΤΙΚΗ

		
05912		1
06066	Λάστιχο O-ring Ανταλ.	1

 01485

 08193

ΦΟΥΣΚΩΤΗΡΑ ΑΡΝΙΩΝ ΜΕΤΑΛΛΙΚΗ

		
01485		1
08193	Δέρμα Ανταλ.	1



ΦΟΥΣΚΩΤΗΡΑ ΑΡΝΙΩΝ ΤΑΪΒΑΝ

02151 πλαστική 6



INTER



ΠΙΣΤΟΛΙΑ ΑΕΡΟΣ ΚΟΝΤΟ

06210 code DG-10-1 5



INTER



ΠΕΤΡΕΛΙΕΡΑ

06212 code D0-10 2



INTER



ΠΙΣΤΟΛΙΑ ΑΕΡΟΣ ΜΕ ΜΑΝΟΜΕΤΡΟ

06209 code DG-10Y 5



INTER



ΠΙΣΤΟΛΙΑ ΑΕΡΟΣ ΜΑΚΡΙΑ ΜΥΤΗ

06211 code DG-10-3 5

02389
03744

GDM
DI MARTINO

02389
03744

ΕΡΓΑΛΕΙΟΘΗΚΗ 15" 38x20x15 cm

02389	μοντέλο 300N	6
03744	μοντέλο 311N	6

03741

GDM
DI MARTINO

ΕΡΓΑΛΕΙΟΘΗΚΗ 15" 38x26x22 cm

03741	μοντέλο 401N	6
-------	--------------	---

03743
03746

GDM
DI MARTINO

03743
03746

ΕΡΓΑΛΕΙΟΘΗΚΗ 23" 58x26x26 cm

03743	μοντέλο 603N	3
03746	μοντέλο 613N	3

03742
03745

GDM
DI MARTINO

03742
03745

ΕΡΓΑΛΕΙΟΘΗΚΗ 19" 48x26x24 cm

03742	μοντέλο 503N	3
03745	μοντέλο 513N	3

04213

GDM
DI MARTINO

ΚΑΣΕΤΙΝΑ ΠΛΑΣΤΙΚΗ CARGO 1000

04213	μοντέλο 720N	12
-------	--------------	----



ΒΑΛΙΤΣΑΚΙ ΔΡΑΠΑΝΟΥ

03747	μοντέλο 711N	2



04565



04566



07490



07490

ΕΡΓΑΛΕΙΟΘΗΚΗ ΜΕΤΑΛΛΙΚΗ

04565	6900 - 400 Δίνατn	1
04566	6900 - 500 Δίνατn	1
07490	6902 -500 Τρίνατn	1



ΤΣΑΝΤΑ ΟΙΚΟΔΟΜΗΣ ΙΝΔΙΑΣ

04653		10



02931



03109



03805



02931

03109

ΕΡΓΑΛΕΙΟΘΗΚΗ ΜΕΤΑΛΛΙΚΗ

02931	code N1 - (ΜxΠxΥ) 38x16x13 cm	1
03109	code N2 - (ΜxΠxΥ) 38x16x13 cm	1
03805	code N3 - (ΜxΠxΥ) 45x20x16 cm	1



ΤΣΑΝΤΑ ΟΙΚΟΔΟΜΗΣ ΜΕΓΑΛΗ

01586		5



**ΠΟΔΙΑ ΟΙΚΟΔΟΜΗΣ ΤΖΙΝ
ΜΕ ΚΛΙΠ & ΦΟΔΡΑ ΔΕΡΜΑ**

01524 12



ΠΟΔΙΑ ΟΙΚΟΔΟΜΗΣ ΔΕΡΜΑΤΙΝΗ

01122 δύο θέσεων 6



ΠΟΔΙΑ ΟΙΚΟΔΟΜΗΣ ΚΑΡΑΒΟΠΑΝΟ

02487 12



ΠΟΔΙΑ ΜΑΡΜΑΡΑΔΩΝ - ΧΛΟΟΚΟΠΤΩΝ

03129 αδιάβροχη 5



**ΠΟΔΙΑ ΟΙΚΟΔΟΜΗΣ ΤΖΙΝ
ΜΕ ΦΟΔΡΑ ΔΕΡΜΑ**

00703 12



00497	00502	00507
00498	00503	00508
00499	00504	00509
00500	00505	
00501	00506	



ΓΕΡΜΑΝΙΚΟ ΚΛΕΙΔΙ

00497	6x7 mm	10
00498	8x9 mm	10
00499	10x11 mm	10
00500	12x13 mm	10
00501	14x15 mm	10
00502	16x17 mm	10
00503	18x19 mm	10
00504	20x22 mm	5
00505	21x33 mm	5
00506	24x26 mm	5
00507	25x28 mm	5
00508	27x32 mm	5
00509	30x32 mm	5



BLISTER

GET IT NOW

01134	01139	01144
01135	01140	01145
01136	01141	01146
01137	01142	
01138	01143	



ΠΟΛΥΓΩΝΟ ΚΛΕΙΔΙ

01134	6x7 mm	10
01135	8x9 mm	10
01136	10x11 mm	10
01137	12x13 mm	10
01138	14x15 mm	10
01139	16x17 mm	5
01140	18x19 mm	10
01141	20x22 mm	5
01142	21x23 mm	5
01143	24x26 mm	5
01144	25x28 mm	5
01145	27x32 mm	5
01146	30x32 mm	5



BLISTER

GET IT NOW

	01970		00243		02581
	02196		00244		01095
	00235		02195		02582
	00236		00245		03688
	00237		02820		02583
	00238		01094		02150
	00239		00246		
	00240		00003		
	00241		02570		
	00242		02770		



BLISTER
GET IT NOW

ΓΕΡΜΑΝΟΠΟΛΥΓΩΝΟ ΚΛΕΙΔΙ

01970	6 mm	10
02196	7 mm	10
00235	8 mm	10
00236	9 mm	10
00237	10 mm	10
00238	11 mm	10
00239	12 mm	10
00240	13 mm	10
00241	14 mm	10
00242	15 mm	10
00243	16 mm	10
00244	17 mm	10
02195	18 mm	10
00245	19 mm	10
02820	20 mm	10
01094	21 mm	5
00246	22 mm	5
00003	23 mm	5
02570	24 mm	5
02770	25 mm	5
02581	26 mm	5
01095	27 mm	5
02582	28 mm	5
03688	29 mm	5
02583	30 mm	5
02150	32 mm	5

	01084
	02438



GET IT NOW



ΓΕΡΜΑΝΙΚΑ ΚΛΕΙΔΙΑ (ΘΗΚΗ)

01084	σετ 8 τμχ.	2
02438	σετ 12 τμχ.	2



Crescent



ΚΑΣΕΤΙΝΑ ΕΡΓΑΛΕΙΩΝ ΧΕΙΡΟΣ

05342	110 τεμαχίων	1



02439



02204



ΓΕΡΜΑΝΟΠΟΥΛΥΓΩΝΑ ΚΛΕΙΔΙΑ (ΘΗΚΗ)

02439	σετ 8 τμχ.	2
02204	σετ 12 τμχ.	1

GET IT NOW



00510



01010



ΠΟΥΛΥΓΩΝΑ ΚΛΕΙΔΙΑ (ΘΗΚΗ)

00510	σετ 8 τμχ.	2
01010	σετ 12 τμχ.	1

GET IT NOW



ΚΛΕΙΔΙΑ ΑΛΛΕΝ 6450

Barcode	Icon	Unit
03839	⊕	12
03840	⊕	12
03841	⊕	12
03907	⊕	6



ΚΛΕΙΔΙΑ ΑΛΛΕΝ ΜΠΙΛΙΑΣ ΤΑΥ ΤΑΪΒΑΝ

Barcode	Icon	Unit
02567	⊕	5



BLISTER

ΚΛΕΙΔΙ TORX ΜΕ ΤΡΥΠΑ

Barcode	Icon	Unit
13019	⊕	6



BLISTER

ΚΛΕΙΔΙΑ ΑΛΛΕΝ ΜΠΙΛΙΑΣ ΤΑΥ ΤΑΪΒΑΝ

Barcode	Icon	Unit
03413	⊕	2



ΚΛΕΙΔΙΑ - ΥΔΡΑΥΛΙΚΟΙ ΓΡΥΛΟΙ

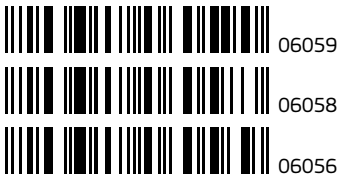

ΜΠΟΥΖΟΚΛΕΙΔΟ ΑΛΥΣΟΠΡΙΟΝΟΥ ΤΑΪΒΑΝ

Barcode	Icon	Icon
06059	R 13/16	10
06058	R 13/19	10
06056	R 17/21	10



ΜΠΟΥΖΟΚΛΕΙΔΟ

Barcode	Icon	Icon
00831	16 mm	10
04679	19 mm	10
04678	21 mm	10
04680	26 mm	10



ΜΠΟΥΖΟΚΛΕΙΔΟ ΣΠΑΣΤΟ ΤΑΪΒΑΝ

Barcode	Icon	Icon
02181	16 mm - 5/8"	12



ΓΡΥΛΟΣ ΑΥΤΟΚΙΝΗΤΟΥ ΥΔΡΑΥΛΙΚΟΣ

Barcode	Icon	Icon
00292	ικανότητα 2 Tn	1
00293	ικανότητα 3 Tn	1
02779	ικανότητα 5 Tn	1
02381	ικανότητα 10 Tn	1



ΚΛΕΙΔΙ ΦΙΛΤΡΟΥ ΤΑΪΒΑΝ

Barcode	Icon	Icon
04741	ρυθμιζόμενο	10

■ NEW ARRIVAL ΝΕΑ ΑΦΙΞΗ ■ HOT SELLER ΚΑΛΥΤΕΡΟ ΣΤΗΝ ΠΩΛΗΣΗ ■ GET IT NOW ΑΞΙΖΕΙ ΝΑ ΑΓΟΡΑΣΕΙΣ ΤΩΡΑ



ΚΑΡΥΔΑΚΙ ΤΑΥ ΤΑΪΒΑΝ

Barcode	Icon	Box
06332	9 mm	5
05755	10 mm	5
01102	11 mm	5
04739	12 mm	5
03821	13 mm	5
05601	17 mm	5
06420	19 mm	5

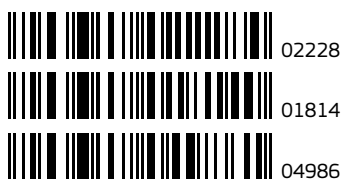

ΚΑΡΥΔΑΚΙ ΜΑΓΝΗΤΙΚΟ ΓΙΑ ΔΡΑΠΑΝΟ ΤΑΪΒΑΝ

Barcode	Icon	Box
02228	6 mm	20
01814	14 mm	10
04986	17 mm	10



ΚΑΡΥΔΑΚΙ 1/2" ΤΑΪΒΑΝ

Barcode	Icon	Box
00657	9 mm	5
02193	15 mm	5
01765	18 mm	5
02477	23 mm	5
01966	27 mm	5



ΚΑΡΥΔΑΚΙ ΑΝΤΑΠΤΟΡΑΣ ΣΕΤ 3 τμχ. ΤΑΪΒΑΝ

Barcode	Icon	Box
04546	1/4" - 3/8" - 1/2"	6

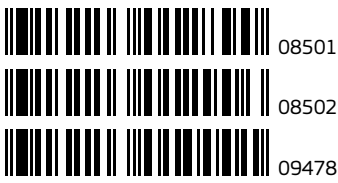

08501

08502

09478



ΑΝΤΑΠΤΟΡΑΣ ΚΑΣΤΑΝΙΑΣ

Barcode	Icon	Quantity
08501	3/8" - 1/4" - (SBS723)	1
08502	3/8" - 1/2" - (SBS724)	1
09478	1/2" - 3/8" - (SB8171)	1



ΠΟΛΥΣΠΑΣΤΟ ΤΑΪΒΑΝ

Barcode	Icon	Quantity
02471	1/2"	5

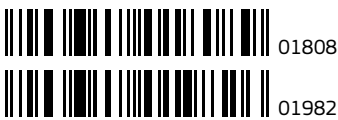

01808

01982



ΠΡΟΕΚΤΑΣΗ ΚΑΣΤΑΝΙΑΣ 1/2" ΤΑΪΒΑΝ

Barcode	Icon	Quantity
01808	μήκος 125 mm	5
01982	μήκος 250 mm	5



ΜΑΝΕΛΑ ΤΑΥ C.V. ΤΑΪΒΑΝ

Barcode	Icon	Quantity
01820	1/2"	5



ΚΑΣΤΑΝΙΑ C.V. ΤΥΠΟΥ ΑCΕSA ΤΑΪΒΑΝ

Barcode	Icon	Quantity
03139	1/2"	5



ΚΑΣΤΑΝΙΑ C.V. ΜΕ ΛΑΣΤΙΧΟ ΤΑΪΒΑΝ

Barcode	Icon	Quantity
00799	1/2"	5



00534

00540

00535

00541

00536

02530

00537

01931

00538

02881



00539



ΣΩΛΗΝΩΤΟ ΚΛΕΙΔΙ

Barcode	Icon	Quantity
00534	6x7 mm	10
00535	8x9 mm	10
00536	10x11 mm	10
00537	12x13 mm	10
00538	14x15 mm	10
00539	16x17 mm	10
00540	18x19 mm	10
00541	20x22 mm	10
02530	21x23 mm	10
01931	24x26 mm	10
02881	25x28 mm	10

02482
02483
00514

MYTH PHILLIPS TITANIOY 25 mm

Barcode	Code	Quantity
02482	PH1 (22341)	10
02483	PH2 (22342)	10
00514	PH3 (22344)	10

02609
02557
00530



MYTH PHILLIPS TITANIOY 50 mm

Barcode	Code	Quantity
02609	PH1 (213621)	10
02557	PH2 (213622)	10
00530	PH3 (213623)	10

00516
00521
00523





MYTH POZIDRIV TITANIOY 25 mm

Barcode	Code	Quantity
00516	PZ1 (22360)	10
00521	PZ2 (22361)	10
00523	PZ3 (22362)	10

00493
00305
02889



MYTH POZIDRIV TITANIOY 50 mm

Barcode	Code	Quantity
00493	PZ1 (213630)	10
00305	PZ2 (213631)	10
02889	PZ3 (213632)	10

02025
00522
01646





MYTH PHILLIPS ΑΠΛΗ 25 mm

Barcode	Code	Quantity
02025	PH1 (12341)	10
00522	PH2 (12342)	10
01646	PH3 (12343)	10

00525
02485
02486



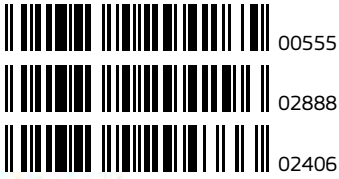

MYTH PHILLIPS ΑΠΛΗ 50 mm

Barcode	Code	Quantity
00525	PH1 (13621)	10
02485	PH2 (13622)	10
02486	PH3 (13623)	10

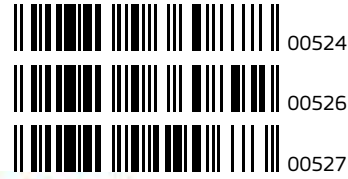

ΜΥΤΗ ΡΟΖΙΔΡΙV ΑΠΛΗ 25 mm

Barcode	Icon	Box
00555	PZ1 (12360)	10
02888	PZ2 (12361)	10
02406	PZ3 (12362)	10



ΜΥΤΗ ΡΟΖΙΔΡΙV ΑΠΛΗ 50 mm

Barcode	Icon	Box
00524	PZ1 (13630)	10
00526	PZ2 (13631)	10
00527	PZ3 (13632)	10

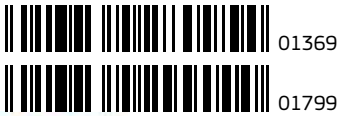

ΜΥΤΗ ΙΣΙΑ ΑΠΛΗ 25 mm

Barcode	Icon	Box
01369	3.0x0.5 (112000)	10
01799	4.5x0.6 (112303)	10

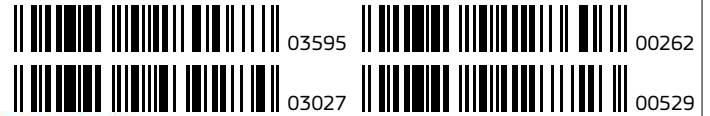

ΜΥΤΗ ΙΣΙΑ ΑΠΛΗ 25 mm

Barcode	Icon	Box
03595	3.0x0.5 (113002)	10
03027	3.5x0.6 (113004)	10
00262	4.5x0.6 (113005)	10
00529	5.5x0.8 (113007)	10

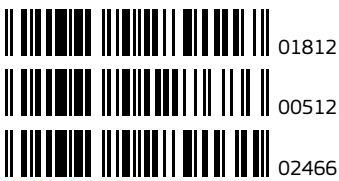

ΜΥΤΗ ROBERTSON ΑΠΛΗ 25 mm

Barcode	Icon	Box
01812	R1 (12027)	10
00512	R2 (12028)	10
02466	R3 (12029)	10

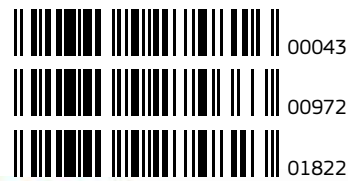

ΜΥΤΗ ROBERTSON ΑΠΛΗ 50 mm

Barcode	Icon	Box
00043	R1 (13017)	10
00972	R2 (13018)	10
01822	R3 (13019)	10





ΜΥΤΗ TORX ΑΠΛΗ 25 mm (ΤΣΙΜΕΝΤΟΒΙΔΑΣ)

		
04952	T30 (12398)	10





ΜΥΤΗ TORX ΑΠΛΗ 50 mm (ΤΣΙΜΕΝΤΟΒΙΔΑΣ)

		
04953	T30 (103659)	10





07036
07035
07034





ΜΥΤΗ ALLEN ΑΠΛΗ 25 mm

		
07036	3	5
07035	4	5
07034	5	5





ΜΥΤΕΣ ΣΕΤ 7 τμχ. TORX



		
13092	6020	1







ΜΥΤΕΣ ΣΕΤ 7 τμχ. PH-PZ-SL

		
13091	6000	1

ΜΥΤΕΣ ΣΕΤ 7 τμχ. PH-PZ

		
13093	6040	1



ΑΝΤΑΠΤΟΡΑΣ ΜΥΤΩΝ



00123



code 15007



5



ΑΝΤΑΠΤΟΡΑΣ ΜΥΤΩΝ ΜΕ ΡΥΘΜΙΖΟΜΕΝΗ ΥΠΟΔΟΧΗ



03692



code 17025



5



ΜΥΤΕΣ ΣΕΤ ΣΕ ΕΚΘΕΤΗΡΙΟ



07299



60 τμχ.



12



ΜΥΤΕΣ ΣΕΤ



13055



33 τμχ.



10





ΣΟΥΒΛΙ

		
03574	μήκος 100 mm	10





ΚΑΤΣΑΒΙΔΙ ΓΙΑ ΜΥΤΕΣ 1/4

		
03578	code BE-8577	5





ΚΑΤΣΑΒΙΔΙ ROBERTSON

		
12281	R1 x 100 mm	10













ΚΑΤΣΑΒΙΔΙ EURO ΔΟΚΙΜΑΣΤΙΚΟ

		
00774	μήκος 150 mm	12
01740	μήκος 190 mm	12







ΚΑΤΣΑΒΙΔΙ ROBERTSON

		
12282	R2 x 125 mm	10
12283	R3 x 125 mm	10







ΚΑΤΣΑΒΙΔΙ ΔΟΚΙΜΑΣΤΙΚΟ

		
02014	μήκος 140 mm	12
02089	μήκος 190 mm	12



BELLOTA

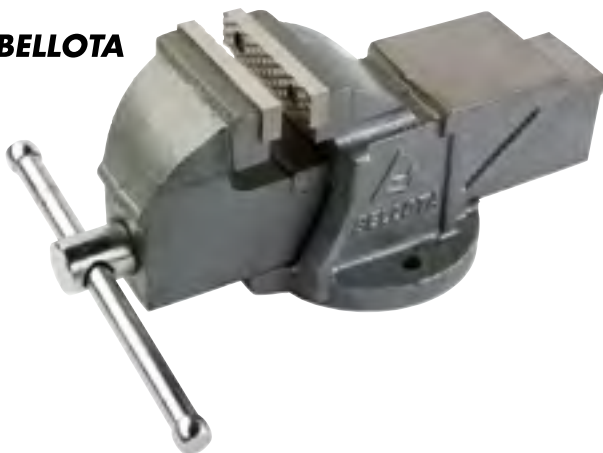

ΜΕΓΓΕΝΗ ΑΤΣΑΛΙΝΗ 6710

Barcode	Icon	Icon
08108	άνοιγμα 75 mm	1
08029	άνοιγμα 100 mm	1
08160	άνοιγμα 125 mm	1
08030	άνοιγμα 150 mm	1



PATCO



ΜΕΓΓΕΝΗ ΑΠΛΗ

Barcode	Icon	Icon
00594	άνοιγμα 75 mm	6
00833	άνοιγμα 100 mm	4
02492	άνοιγμα 125 mm	4
01513	άνοιγμα 150 mm	1



PATCO



ΜΕΓΓΕΝΗ ΑΤΣΑΛΙΝΗ ΒΑΡΕΩΣ ΤΥΠΟΥ

Barcode	Icon	Icon
01419	άνοιγμα 75 mm	6
01707	άνοιγμα 100 mm	4
01708	άνοιγμα 125 mm	2
02558	άνοιγμα 150 mm	2





PATCO





ΜΕΓΓΕΝΗ ΒΙΔΑΣ

Barcode	Icon	Icon
00846	άνοιγμα 60 mm	1
00847	άνοιγμα 70 mm	1

ΠΟΝΤΑ Φ 10 mm

		
02504	μήκος 100 mm	10





ΖΟΥΜΠΑΔΕΣ Φ10 x 120 mm

		
02502	No 1-2-3-4	10





ΜΑΝΤΑΛΑΚΙ ΞΥΛΟΥΡΓΩΝ ΠΛΑΣΤΙΚΟ

		
03378	μήκος 100 mm - 4"	10
03379	μήκος 150 mm - 6"	10











ΣΦΙΓΚΤΗΡΑΣ ΜΑΡΑΓΚΩΝ

		
01412	(βαθος x άνοιγμα) 80x200 mm	5
01411	(βαθος x άνοιγμα) 80x250 mm	5
01410	(βαθος x άνοιγμα) 80x300 mm	5
01409	(βαθος x άνοιγμα) 120x250 mm	5
01413	(βαθος x άνοιγμα) 120x300 mm	5
01414	(βαθος x άνοιγμα) 120x400 mm	5
01415	(βαθος x άνοιγμα) 120x600 mm	5





ΠΛΑΝΗ ΣΙΔΕΡΕΝΙΑ

		
01997	228x50 mm	1

smirdex

**ΡΑΣΠΑ ΜΕΤΑΛΛΙΚΗ 966
ΓΙΑ VELCRO ΧΩΡΙΣ ΤΡΥΠΕΣ**

12023	400 x70 mm	1

BAHCO

ΣΕΓΑΤΣΑ 2600

03597	μήκος λάμας 475 mm (19XT-HP)	4
04470	μήκος λάμας 550 mm (22XT-HP)	4

BELLOTA

ΣΕΓΑΤΣΑ 4555

05181	μήκος λάμας 350 mm (14")	6
00183	μήκος λάμας 400 mm (16")	6

TopMan

ΠΡΙΟΝΙ ΜΕΛΑΜΙΝΗΣ 8006

13375	μήκος λάμας 240 mm	10
13376	λάμα ανταλλακτική	6

GET IT NOW

BAHCO

ΣΕΓΑΤΣΑ ΝΡ

06516	μήκος λάμας 400 mm (16-U7/8-HP)	4
06518	μήκος λάμας 475 mm (19-U7/8-HP)	5
06517	μήκος λάμας 550 mm (22-U7/8-HP)	2

KOY

ΠΡΙΟΝΙ ΜΕΛΑΜΙΝΗΣ

07286	μήκος λάμας 250 mm (KEG - 250P)	12
07924	λάμα ανταλλακτική	15

TopMan

ΠΡΙΟΝΙ ΜΕΛΑΜΙΝΗΣ 8007

02199	μήκος λάμας 265 mm	10
06103	λάμα ανταλλακτική	6

GET IT NOW

ΠΡΙΟΝΙΑ ΓΥΦΟΣΑΝΙΔΑΣ - ΤΟΞΟΠΡΙΟΝΑ - ΣΚΕΛΕΤΑ



14076
14077

KDS

ΠΡΙΟΝΙΑ ΜΕΛΑΜΙΝΗΣ KDS

14076	μήκος λάμας 235 mm (PW-235)	10
14077	λάμα ανταλλακτική	10



TopMan

ΠΡΙΟΝΙ ΓΥΦΟΣΑΝΙΔΑΣ 1156

00189	μήκος λάμας 150 mm	12
-------	--------------------	----



00995
02286

BELLOTA

ΠΡΙΟΝΙ ΤΟΞΟΥ 4534

00995	μήκος λάμας 530 mm	12
02286	μήκος λάμας 760 mm	6



00705
00706
00708

BELLOTA

ΛΑΜΑ ΤΟΞΟΥ 4536

00705	μήκος λάμας 530 mm - 21"	12
00706	μήκος λάμας 610 mm - 24"	12
00708	μήκος λάμας 760 mm - 30"	12



IRWIN

ΠΡΙΟΝΙ ΤΟΞΟΥ JACK BASIC

13095	μήκος λάμας 450 mm - 18"	6
-------	--------------------------	---



Nicholson

ΣΚΕΛΕΤΑ

05344	σετ 3 τμχ	1
-------	-----------	---



ΦΑΛΤΣΟΚΟΥΤΙ ΜΕ ΠΡΙΟΝΙ ΤΑΪΒΑΝ

05826	μήκος 300 mm	6



ΦΑΛΤΣΟΚΟΥΤΙ ΜΕ ΠΡΙΟΝΙ

01061	μήκος 250 mm	6



01975



01976



ΣΚΕΛΕΤΟ MINI

01975	μήκος 150 mm	20
01976	λάμα ανταλλακτική	20



ΣΚΕΛΕΤΟ ΠΡΙΟΝΙΩΝ 4621-12

01879	μήκος λάμας 300 mm	6



ΠΡΙΟΝΙ ΚΡΕΟΠΛΩΝ ΓΕΡΜΑΝΙΑΣ

01089	μήκος λάμας 500 mm	2



01874



04363



ΛΑΜΑ ΚΡΕΟΠΛΩΝ

01874	(μήκος x πλάτος) 500x20 mm	10
04363	(μήκος x πλάτος) 550x20 mm	10

ΠΡΙΟΝΟΛΑΜΕΣ



MPS



ΛΑΜΑ ΑΕΡΟΣ



04422



300 x 13 x 0,63 mm



100



ΛΑΜΑ ΑΓΚΥΡΑΣ



00714



μήκος 300 mm



72



MPS

BLISTER



ΛΑΜΕΣ ΣΕΓΑΣ 130 mm ΞΥΛΟΥ - ΜΕΤΑΛΛΟΥ



04413

code 3450F
(Black & Decker)



10



MPS

BLISTER



ΛΑΜΕΣ ΣΕΓΑΣ 130 mm ΞΥΛΟΥ - ΜΕΤΑΛΛΟΥ



04412

code 3150F
(BOSCH)



10



MPS

BLISTER



ΛΑΜΕΣ ΣΕΓΑΣ 100 mm ΞΥΛΟΥ - ΜΕΤΑΛΛΟΥ



07063

code 3188
(BOSCH)



10



ΠΟΤΗΡΟΤΡΥΠΑΝΑ

	04371		04381		04392		04403
	04372		04382		04393		04404
	04373		04383		04394		04405
	05635		04384		04395		04406
	04374		04385		04396		04407
	04375		04386		04397		04408
	04376		04387		04398		05608
	04377		04388		04399		05611
	04378		04389		04400		05613
	04379		04390		04401		05614
	04380		04391		04402		

MPS

GET IT NOW



ΠΟΤΗΡΟΤΡΥΠΑΝΟ HSS-METAL

04371	Ø17 mm	1
04372	Ø19 mm	1
04373	Ø20 mm	1
05635	Ø21 mm	1
04374	Ø22 mm	1
04375	Ø24 mm	1
04376	Ø25 mm	1
04377	Ø27 mm	1
04378	Ø30 mm	1
04379	Ø32 mm	1
04380	Ø33 mm	1
04381	Ø35 mm	1
04382	Ø40 mm	1
04383	Ø41 mm	1
04384	Ø43 mm	1
04385	Ø44 mm	1
04386	Ø45 mm	1
04387	Ø46 mm	1
04388	Ø48 mm	1
04389	Ø50 mm	1
04390	Ø51 mm	1

04391	Ø52 mm	1
04392	Ø54 mm	1
04393	Ø57 mm	1
04394	Ø60 mm	1
04395	Ø64 mm	1
04396	Ø65 mm	1
04397	Ø68 mm	1
04398	Ø70 mm	1
04399	Ø73 mm	1
04400	Ø76 mm	1
04401	Ø79 mm	1
04402	Ø83 mm	1
04403	Ø86 mm	1
04404	Ø89 mm	1
04405	Ø92 mm	1
04406	Ø95 mm	1
04407	Ø98 mm	1
04408	Ø102 mm	1
05608	Ø108 mm	1
05611	Ø121 mm	1
05613	Ø127 mm	1
05614	Ø140 mm	1

■ NEW ARRIVAL ΝΕΑ ΑΦΙΞΗ ■ HOT SELLER ΚΑΛΥΤΕΡΟ ΣΤΗΝ ΠΩΛΗΣΗ ■ GET IT NOW ΑΞΙΖΕΙ ΝΑ ΑΓΟΡΑΣΕΙΣ ΤΩΡΑ



M.P.S.



ΕΚΘΕΤΗΡΙΟ ΠΟΤΗΡΟΤΡΥΠΑΝΩΝ 35 ΘΕΣΕΩΝ

01488		1



M.P.S.



ΠΟΤΗΡΟΤΡΥΠΑΝΑ ΣΕΤ 6 τμχ. HSS ΓΙΑ ΜΕΤΑΛΛΑ

04977	Φ 22,29,35,44,57,68 mm	1



04409



04410

M.P.S.

04409



04410



ΥΠΟΔΟΧΕΣ ΠΟΤΗΡΟΤΡΥΠΑΝΩΝ

04409	Φ 14-30 mm	1
04410	Φ 32-210 mm	1



04535



04534



08368



04531



08369



04536



04532



ΠΟΤΗΡΟΤΡΥΠΑΝΑ ΚΑΡΒΙΔΙΟΥ 3832

04535	Φ 25 mm	1
08368	Φ 33 mm	1
08369	Φ 37 mm	1
04532	Φ 40 mm	1
04534	Φ 44 mm	1
04531	Φ 60 mm	1
04536	Φ 76 mm	1



ΠΟΤΗΡΟΤΡΥΠΑΝΑ ΠΛΑΚΙΔΙΩΝ ΣΕΤ 5 τμχ. ΤΑΪΒΑΝ

05829	Ø 33-53-67-73-83 mm	3



05803



02970



04976



ΠΟΤΗΡΟΤΡΥΠΑΝΑ ΞΥΛΟΥ ΣΕΤ

05803	Ø 32-38-45-51-57-63 mm	6
02970	Ø 46-53-59-66-73-82-94 mm	6
04976	Ø 68-74-83-92-102-114-121 mm	4



01843



01849



BLISTER



No. 2012 020

7 Blade Hole Saw
20mm (3/4") Depth Blades

Size: 25mm (1") diam
25, 32, 38, 45
51, 57, 63mm

No. 2012 045

7 Blade Hole Saw
45mm (1-3/4") Depth Blades

Size: 50mm (2") diam
51, 57, 63, 69
74, 81, 88mm

ΠΟΤΗΡΟΤΡΥΠΑΝΑ ΣΕΤ 7 τμχ. Ø25-32-38-45-51-57-63 mm

01843	βάθος 20 mm	6
01849	βάθος 45 mm	6

ΒΕΛΟΝΟΚΑΛΕΜΑ SDS-PLUS - ΤΡΥΠΑΝΙΑ



REX BLISTER



ΚΑΛΕΜΙ SDS-PLUS ΚΥΡΤΟ ΓΙΑ ΠΛΑΚΑΚΙΑ



		
05516	250x40 mm	5



REX BLISTER



ΚΑΛΕΜΙ SDS-PLUS ΚΟΠΙΔΙ



		
02886	250x20 mm	5



REX BLISTER



ΚΑΛΕΜΙ SDS-PLUS ΧΟΥΦΤΑ



		
01201	250x22 mm	5



REX BLISTER



ΚΑΛΕΜΙ SDS-PLUS ΦΑΡΔΥ



		
05424	250x40 mm	5



REX BLISTER



ΚΑΛΕΜΙ SDS-PLUS ΒΕΛΟΝΙ

		
00830	μήκος 250 mm	5



02001  02343



02002  01934



02003  02044



01469  03017



00567  05439





00374 

REX HOT SELLER

GET IT NOW



ΤΡΥΠΑΝΙ ΔΙΑΜΑΝΤΕ

		
02001	(Φ x μήκος) 3x60 / 32 mm	5
02002	(Φ x μήκος) 4x75 / 40 mm	5
02003	(Φ x μήκος) 5x85 / 42 mm	5
01469	(Φ x μήκος) 6x100 / 53 mm	5
00567	(Φ x μήκος) 7x100 / 53 mm	5
00374	(Φ x μήκος) 8x120 / 75 mm	5
02343	(Φ x μήκος) 9x120 / 75 mm	5
01934	(Φ x μήκος) 10x120 / 75 mm	5
02044	(Φ x μήκος) 12x150 / 90 mm	5
03017	(Φ x μήκος) 14x150 / 90 mm	5
05439	(Φ x μήκος) 16x150 / 90 mm	5

	05416		01712
	05417		03653
	03651		03136
	03962		01710
	01714		01206
	03652		00605
	03963		



ΤΡΥΠΑΝΙΑ ΔΙΑΜΑΝΤΕ ΜΑΚΡΥ

05416	(Φ x μήκος) 6x300 / 220 mm	5
05417	(Φ x μήκος) 6x400 / 275 mm	5
03651	(Φ x μήκος) 8x200 / 135 mm	5
03962	(Φ x μήκος) 8x300 / 220 mm	5
01714	(Φ x μήκος) 8x400 / 275 mm	5
03652	(Φ x μήκος) 10x200 / 135 mm	5
03963	(Φ x μήκος) 10x300 / 220 mm	5
01712	(Φ x μήκος) 10x400 / 275 mm	5
03653	(Φ x μήκος) 12x220 / 150 mm	5
03136	(Φ x μήκος) 12x300 / 220 mm	5
01710	(Φ x μήκος) 12x400 / 275 mm	5
01206	(Φ x μήκος) 14x400 / 275 mm	5
00605	(Φ x μήκος) 16x400 / 275 mm	5

	01655
	00854



ΤΡΥΠΑΝΙΑ ΔΙΑΜΑΝΤΕ

01655	14x150 mm	5
00854	15x150 mm	5

	13724		13728
	13725		13729
	13726		13730
	13727		



ΤΡΥΠΑΝΙΑ ΓΡΑΝΙΤΗ ΔΙΑΜΑΝΤΕ JUMBO

13724	(Φ x μήκος) 4x85 / 50 mm	5
13725	(Φ x μήκος) 5x95 / 55 mm	5
13726	(Φ x μήκος) 6x100 / 60 mm	5
13727	(Φ x μήκος) 7x100 / 60 mm	5
13728	(Φ x μήκος) 8x120 / 70 mm	5
13729	(Φ x μήκος) 10x120 / 70 mm	5
13730	(Φ x μήκος) 12x150 / 90 mm	5



ΔΙΑΜΑΝΤΟΤΡΥΠΑΝΑ ΣΕΤ

01687	4 τμχ.	5

	03966		03969
	03967		03970
	03968		



ΤΡΥΠΑΝΙΑ ΓΕΝΙΚΗΣ ΧΡΗΣΗΣ

03966	(Φ x μήκος) 4x85 / 50 mm	10
03967	(Φ x μήκος) 5x95 / 50 mm	10
03968	(Φ x μήκος) 6x100 / 60 mm	10
03969	(Φ x μήκος) 8x120 / 80 mm	10
03970	(Φ x μήκος) 10x120 / 70 mm	10

	01932		01632
	01571		02858
	01845		01510
	01000		02440
	00011		01633
	02060		01726
	01652		13945
	01990		01798
	02316		06619
	01568		06881
	01030		03212



ΤΡΥΠΑΝΙ SDS-PLUS (2ΚΟΠΟ)

01932	(Φ x μήκος) 5x160 / 100 mm	10
01571	(Φ x μήκος) 6x110 / 50 mm	10
01845	(Φ x μήκος) 6x160 / 100 mm	10
01000	(Φ x μήκος) 6x200 / 150 mm	10
00011	(Φ x μήκος) 6x260 / 200 mm	5
02060	(Φ x μήκος) 7x110 / 50 mm	10
01652	(Φ x μήκος) 7x160 / 100 mm	10
01990	(Φ x μήκος) 8x110 / 50 mm	10
02316	(Φ x μήκος) 8x160 / 100 mm	10
01568	(Φ x μήκος) 8x210 / 150 mm	10
01030	(Φ x μήκος) 8x260 / 200 mm	5
01632	(Φ x μήκος) 10x160 / 100 mm	10
02858	(Φ x μήκος) 10x210 / 150 mm	10
01510	(Φ x μήκος) 10x310 / 250 mm	5
02440	(Φ x μήκος) 12x160 / 100 mm	5
01633	(Φ x μήκος) 12x210 / 150 mm	5
01726	(Φ x μήκος) 12x260 / 200 mm	5
13945	(Φ x μήκος) 12x310 / 250 mm	5
01798	(Φ x μήκος) 14x160 / 100 mm	5
06619	(Φ x μήκος) 14x200 / 150 mm	5
06881	(Φ x μήκος) 12x300 / 250 mm	5
03212	(Φ x μήκος) 16x200 / 150 mm	5

ΤΡΥΠΑΝΙΑ ΣΕΤ 13 τμχ.

01507	τιτανίου	5

	06983		06988
	06984		06989
	06985		06990
	06986		06991
	06987		



ΤΡΥΠΑΝΙ ΑΕΡΟΣ ΜΑΚΡΥ

06983	(Φ x μήκος) 3,5x112 mm	10
06984	(Φ x μήκος) 4,0x119 mm	10
06985	(Φ x μήκος) 4,5x126 mm	10
06986	(Φ x μήκος) 5,0x132 mm	10
06987	(Φ x μήκος) 5,5x139 mm	10
06988	(Φ x μήκος) 6,0x148 mm	5
06989	(Φ x μήκος) 6,5x157 mm	5
06990	(Φ x μήκος) 8,0x165 mm	5
06991	(Φ x μήκος) 10x184 mm	5

ΤΡΥΠΑΝΙ ΞΥΛΟΥ ΜΑΚΡΥ

05518	(Φ x μήκος) 10x400 mm	5

	01657		01730
	01658		01670
	01501		01729
	01425		01672
	00284		01803
	00285		01674
	02545		01426
	02522		01676
	00271		01627
	01433		01678
	00518		01212
	01584		01681



ΤΡΥΠΑΝΙΑ ΑΕΡΟΣ

01657	Φ 1,0 mm	10
01658	Φ 1,5 mm	10
01501	Φ 2,0 mm	10
01425	Φ 2,5 mm	10
00284	Φ 3,0 mm	10
00285	Φ 3,5 mm	10
02545	Φ 4,0 mm	10
02522	Φ 4,5 mm	10
00271	Φ 5,0 mm	10
01433	Φ 5,5 mm	10
00518	Φ 6,0 mm	10
01584	Φ 6,5 mm	10
01730	Φ 7,0 mm	10
01670	Φ 7,5 mm	10
01729	Φ 8,0 mm	10
01672	Φ 8,5 mm	10
01803	Φ 9,0 mm	10
01674	Φ 9,5 mm	10
01426	Φ 10,0 mm	10
01676	Φ 10,5 mm	5
01627	Φ 11,0 mm	5
01678	Φ 11,5 mm	5
01212	Φ 12,0 mm	5
01681	Φ 13,0 mm	5



ΕΚΘΕΤΗΡΙΟ ΤΡΥΠΑΝΙΩΝ

09790		1



ΕΚΘΕΤΗΡΙΟ ΠΑΓΚΟΥ ΤΡΥΠΑΝΙΩΝ (25 ΘΕΣΕΩΝ)

13823		1



ΕΚΘΕΤΗΡΙΟ ΤΡΥΠΑΝΙΩΝ

05470		1



01682



00351



ΤΡΥΠΑΝΙΑ ΑΕΡΟΣ

Barcode	Icon	Quantity
01682	(Φ x μήκος) 14x160 / 108 mm	5
00351	(Φ x μήκος) 16x178 / 120 mm	5

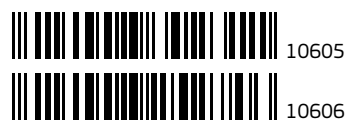

10605



10606

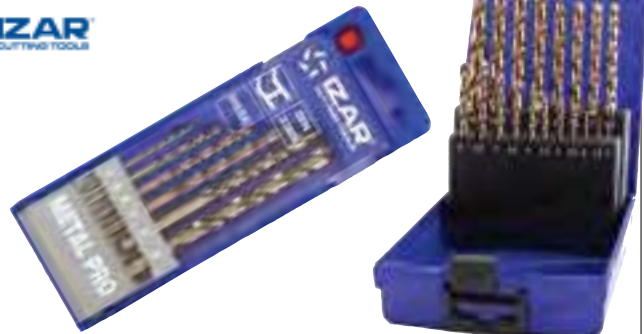

ΤΡΥΠΑΝΙΑ ΚΟΒΑΛΤΙΟΥ 5% ΣΕΤ

Barcode	Icon	Quantity
10605	6 τμχ.	1
10606	19 τμχ.	1



ΤΡΥΠΑΝΙΑ ΚΟΒΑΛΤΙΟΥ 5%

Barcode	Icon	Quantity
05390	Φ 1,0 mm	10
05348	Φ 1,5 mm	10
01023	Φ 2,0 mm	10
03333	Φ 2,5 mm	10
03334	Φ 3,0 mm	10
01758	Φ 3,5 mm	10
03335	Φ 4,0 mm	10
04314	Φ 4,2 mm	10
02278	Φ 4,5 mm	10
00945	Φ 5,0 mm	10
04315	Φ 5,5 mm	10
03336	Φ 6,0 mm	10
04316	Φ 6,5 mm	10
02094	Φ 7,0 mm	10



HOT
SELLER

04317	Φ 7,5 mm	10
03337	Φ 8,0 mm	10
05148	Φ 8,5 mm	10
05149	Φ 9,0 mm	10
05152	Φ 9,5 mm	10
03338	Φ 10,0 mm	10
05150	Φ 10,5 mm	5
05151	Φ 11,0 mm	5
13003	Φ 11,5 mm	5
03339	Φ 12,0 mm	5
13004	Φ 12,5 mm	5
05440	Φ 13,0 mm	5
13005	Φ 13,5 mm	1
05441	Φ 14,0 mm	1



ΦΡΕΖΑ ΞΥΛΟΥ 2101

Barcode	Icon	Box
04421	No 7, Φ 4 mm	6

09701	09707
09702	09708
09703	09709
09704	09710
09705	09711
09706	



ΤΡΥΠΑΝΙΑ ΞΥΛΟΥ

Barcode	Icon	Box
09701	(Φ x μήκος) 3x50 mm	5
09702	(Φ x μήκος) 4x75 mm	5
09703	(Φ x μήκος) 5x85 mm	5
09704	(Φ x μήκος) 6x95 mm	5
09705	(Φ x μήκος) 7x110 mm	5
09706	(Φ x μήκος) 8x115 mm	5
09707	(Φ x μήκος) 10x135 mm	5
09708	(Φ x μήκος) 12x155 mm	5
09709	(Φ x μήκος) 14x170 mm	5
09710	(Φ x μήκος) 16x180 mm	5
09711	(Φ x μήκος) 20x200 mm	5

09713	09722
09714	09723
09715	09724
09716	09725
09717	09726
09718	09727
09719	



ΤΡΥΠΑΝΙΑ ΦΤΕΡΟΥ ΤΙΤΑΝΙΟΥ (ΜΗΚΟΣ 152 mm)

Barcode	Icon	Box
09713	Φ 8 mm	5
09714	Φ 10 mm	5
09715	Φ 12 mm	5
09716	Φ 14 mm	5
09717	Φ 16 mm	5
09718	Φ 18 mm	5
09719	Φ 20 mm	5
09722	Φ 25 mm	5
09723	Φ 26 mm	5
09724	Φ 28 mm	5
09725	Φ 30 mm	5
09726	Φ 32 mm	5
09727	Φ 35 mm	5



ΤΡΥΠΑΝΙΑ ΞΥΛΟΥ ΣΕΤ 7 ΤΜΧ. ΣΕ ΚΑΣΕΤΙΝΑ

Barcode	Icon	Box
09712	Φ 3-4-5-6-7-8-10 mm	2





ΤΡΥΠΑΝΙΑ ΦΤΕΡΟΥ ΣΕΤ 6 ΤΜΧ. ΤΙΤΑΝΙΟΥ (ΜΗΚΟΣ 152 mm)



Barcode	Icon	Box
09729	Φ 10-12-14-16-18-20 mm	2















	02961		03005
	03004		00074
	02962		02964
	02963		10667





ΒΙΔΑ ΕΞΑΓΩΝΗ ΓΑΛΒΑΝΙΖΕ Μ5 (DIN933)

		
02961	Φ 5X16 mm	960
03004	Φ 5x20 mm	800
02962	Φ 5x25 mm	600
02963	Φ 5X30 mm	560
03005	Φ 5X35 mm	200
00074	Φ 5X40 mm	360
02964	Φ 5X50 mm	260
10667	Φ 5X60 mm	200

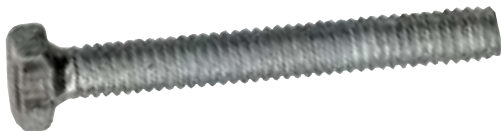
	00226		01096
	00205		01100
	00206		01098
	00770		01486
	04752		02604
	02553		01827
	02526		





ΒΙΔΑ ΕΞΑΓΩΝΗ ΓΑΛΒΑΝΙΖΕ Μ6 (DIN933)

		
00226	Φ 6x15 mm	600
00205	Φ 6x20 mm	500
00206	Φ 6x25 mm	450
00770	Φ 6x30 mm	800
04752	Φ 6x35 mm	200
02553	Φ 6x40 mm	300
02526	Φ 6x50 mm	300
01096	Φ 6x60 mm	200
01100	Φ 6x70 mm	200
01098	Φ 6x80 mm	175
01486	Φ 6x90 mm	150
02604	Φ 6x100 mm	150
01827	Φ 6x120 mm	120

	00207		00214
	00208		01053
	00209		06513
	00210		02527
	04278		00215
	00211		05174
	00212		05175
	00213		



ΒΙΔΑ ΕΞΑΓΩΝΗ ΓΑΛΒΑΝΙΖΕ Μ8 (DIN933)

		
00207	Φ 8x15 mm	250
00208	Φ 8x20 mm	200
00209	Φ 8x25 mm	240
00210	Φ 8x30 mm	200
04278	Φ 8x35 mm	370
00211	Φ 8x40 mm	150
00212	Φ 8x50 mm	120
00213	Φ 8x60 mm	120
00214	Φ 8x70 mm	100
01053	Φ 8x80 mm	100
06513	Φ 8x90 mm	85
02527	Φ 8x100 mm	75
00215	Φ 8x120 mm	60
05174	Φ 8x140 mm	75
05175	Φ 8x150 mm	50

ΒΙΔΑ ΕΞΑΓΩΝΗ ΓΑΛΒΑΝΙΖΕ M10 (DIN933)

Barcode	Part Number	Dimensions	Quantity
	03030	Φ 10x20 mm	120
	02958	Φ 10x25 mm	300
	02959	Φ 10x30 mm	100
	00544	Φ 10x35 mm	200
	02960	Φ 10x40 mm	100
	02627	Φ 10x50 mm	80

02628	Φ 10x60 mm	70
02629	Φ 10x70 mm	60
02630	Φ 10x80 mm	55
01850	Φ 10x90 mm	100
00216	Φ 10x100 mm	50
00217	Φ 10x120 mm	80
00218	Φ 10x140 mm	40

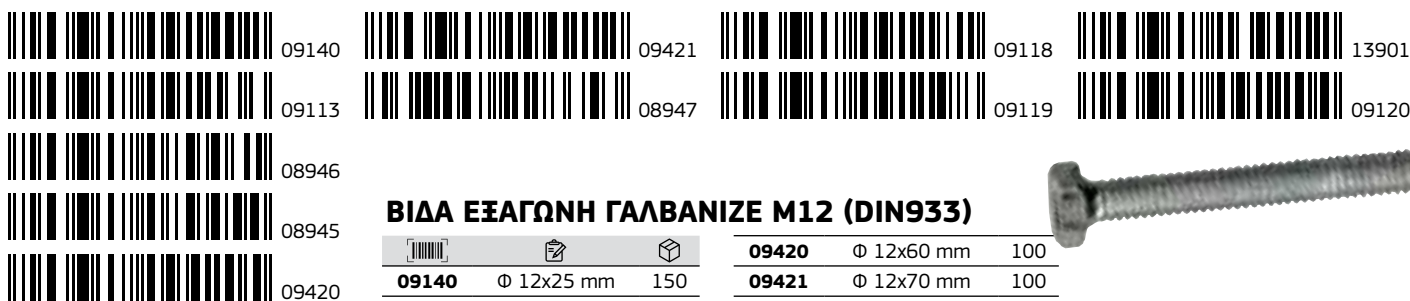
ΒΙΔΑ ΕΞΑΓΩΝΗ ΓΑΛΒΑΝΙΖΕ M12 (DIN933)

Barcode	Part Number	Dimensions	Quantity
	09140	Φ 12x25 mm	150
	09113	Φ 12x30 mm	100
	08946	Φ 12x40 mm	100
	08945	Φ 12x50 mm	100

09420	Φ 12x60 mm	100
09421	Φ 12x70 mm	100
08947	Φ 12x80 mm	50
09118	Φ 12x100 mm	50
09119	Φ 12x140 mm	50
13901	Φ 12x150 mm	30
09120	Φ 12x180 mm	25

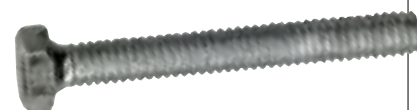
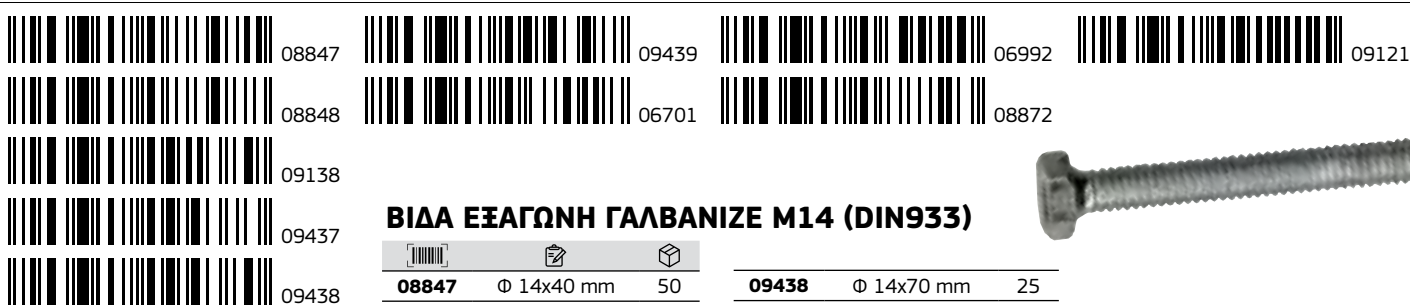
ΒΙΔΑ ΕΞΑΓΩΝΗ ΓΑΛΒΑΝΙΖΕ M14 (DIN933)

Barcode	Part Number	Dimensions	Quantity
	08847	Φ 14x40 mm	50
	08848	Φ 14x45 mm	50
	09138	Φ 14x50 mm	50
	09437	Φ 14x60 mm	50

09438	Φ 14x70 mm	25
09439	Φ 14x80 mm	50
06701	Φ 14x90 mm	40
06992	Φ 14x120 mm	25
08872	Φ 14x140 mm	25
09121	Φ 14x160 mm	30

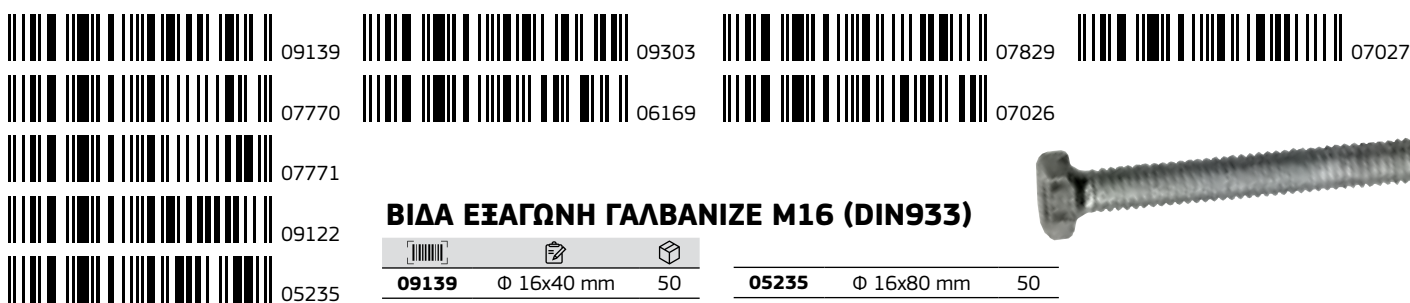
ΒΙΔΑ ΕΞΑΓΩΝΗ ΓΑΛΒΑΝΙΖΕ M16 (DIN933)

Barcode	Part Number	Dimensions	Quantity
	09139	Φ 16x40 mm	50
	07770	Φ 16x50 mm	50
	07771	Φ 16x60 mm	50
	09122	Φ 16x70 mm	50

05235	Φ 16x80 mm	50
09303	Φ 16x90 mm	25
06169	Φ 16x100 mm	25
07829	Φ 16x120 mm	30
07026	Φ 16x140 mm	25
07027	Φ 16x160 mm	15



ΒΙΔΑ ΕΞΑΓΩΝΗ ΓΑΛΒΑΝΙΖΕ M18 (DIN933)

Barcode	Icon	Quantity
07772	Φ 18x50 mm	50
07773	Φ 18x60 mm	25
07774	Φ 18x80 mm	30
06033	Φ 18x100 mm	25
07828	Φ 18x120 mm	25

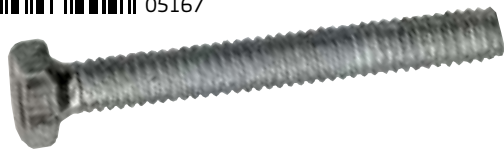
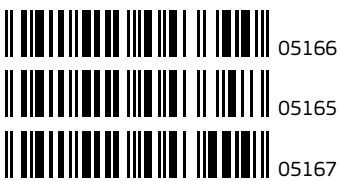

ΒΙΔΑ ΕΞΑΓΩΝΗ INOX M3 (DIN933)

Barcode	Icon	Quantity
05166	Φ 3X16 mm	1000
05165	Φ 3X20 mm	1000
05167	Φ 3X30 mm	1000

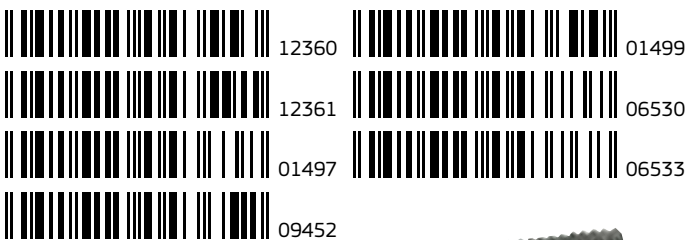

ΒΙΔΑ ΕΞΑΓΩΝΗ INOX M4 (DIN933)

Barcode	Icon	Quantity
12360	Φ 4X16 mm	1000
12361	Φ 4X20 mm	1000
01497	Φ 4X25 mm	500
09452	Φ 4X30 mm	500
01499	Φ 4X40 mm	500
06530	Φ 4X50 mm	500
06533	Φ 4X60 mm	200



NEW ARRIVAL











ΒΙΔΑ ΕΞΑΓΩΝΗ INOX M5 (DIN933)

Barcode	Icon	Quantity
12362	Φ 5x12 mm	500
14862	Φ 5x16 mm	500
03254	Φ 5x20 mm	500
01173	Φ 5x25 mm	500
05871	Φ 5x30 mm	500
05075	Φ 5x35 mm	500
01174	Φ 5x40 mm	500
06253	Φ 5x50 mm	150
03255	Φ 5x60 mm	200
05874	Φ 5x70 mm	200



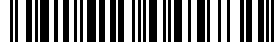

ΒΙΔΑ ΕΞΑΓΩΝΗ INOX M6 (DIN933)

Barcode	Icon	Quantity
02445	Φ 6x16 mm	200
02938	Φ 6x20 mm	200
03114	Φ 6x25 mm	200
02939	Φ 6x30 mm	200
03256	Φ 6x35 mm	200
02508	Φ 6x40 mm	200
03257	Φ 6x50 mm	100
02941	Φ 6x60 mm	100
07055	Φ 6x70 mm	100
06534	Φ 6x80 mm	100
06556	Φ 6x90 mm	100
06535	Φ 6x100 mm	100

	03264		03406
	02942		03407
	02943		01594
	05876		04166
	02945		02542
	13370		14600
	01855		



ΒΙΔΑ ΕΞΑΓΩΝΗ INOX M8 (DIN933)

		
03264	Φ 8x20 mm	200
02942	Φ 8x25 mm	100
02943	Φ 8x30 mm	100



NEW
ARRIVAL

05876	Φ 8x35 mm	100
02945	Φ 8x40 mm	100
13370	Φ 8x45 mm	100
01855	Φ 8x50 mm	100
03406	Φ 8x60 mm	100
03407	Φ 8x70 mm	100
01594	Φ 8x80 mm	50
04166	Φ 8x90 mm	100
02542	Φ 8x100 mm	50
14600	Φ 8x120 mm	50



	05299		01154
	05300		09467
	13371		09468
	01435		02310
	05420		14908
	05238		

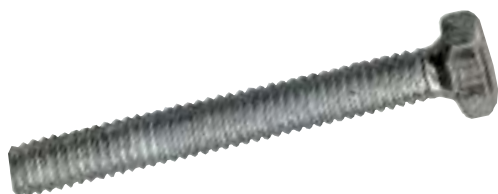

NEW
ARRIVAL



ΒΙΔΑ ΕΞΑΓΩΝΗ INOX M10 (DIN933)

		
05299	Φ 10x20 mm	100
05300	Φ 10x30 mm	100
13371	Φ 10x35 mm	100
01435	Φ 10x40 mm	100
05420	Φ 10x50 mm	50
05238	Φ 10x60 mm	50
01154	Φ 10x70 mm	50
09467	Φ 10x80 mm	50
09468	Φ 10x90 mm	50
02310	Φ 10x100 mm	50
14908	Φ 10x120 mm	50



	10089
	10090
	06028
	08367
	13002
	06186
	14601

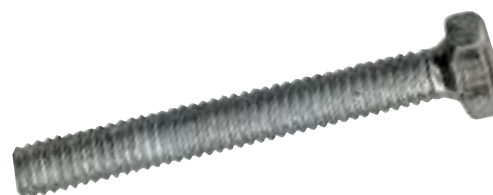

NEW
ARRIVAL



ΒΙΔΑ ΕΞΑΓΩΝΗ INOX M12 (DIN933)

		
10089	Φ 12x30 mm	100
10090	Φ 12x40 mm	100
06028	Φ 12x50 mm	50
08367	Φ 12x60 mm	50
13002	Φ 12x70 mm	50
06186	Φ 12x80 mm	50
14601	Φ 12x100 mm	25

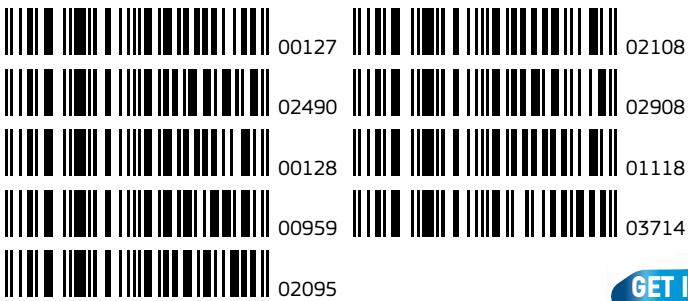

GET IT NOW

ΝΤΙΖΑ ΓΑΛΒΑΝΙΖΕ 1 m (DIN975)

Barcode	Icon	Code
00127	M 6 mm	100
02490	M 8 mm	50
00128	M 10 mm	25
00959	M 12 mm	20
02095	M 14 mm	10
02108	M 16 mm	10
02908	M 18 mm	10
01118	M 20 mm	8
03714	M 24 mm	5



ΝΤΙΖΑ INOX 1 m

Barcode	Icon	Code
09458	M 5 mm	5
05466	M 6 mm	5
05249	M 8 mm	5
03296	M 10 mm	5
01007	M 12 mm	5
03297	M 14 mm	10
09459	M 16 mm	5
09460	M 18 mm	5
09461	M 20 mm	5
09462	M 22 mm	5
09463	M 24 mm	5

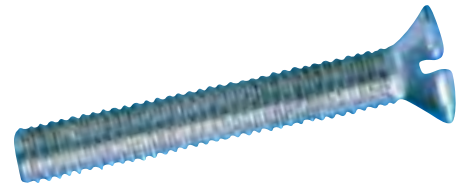
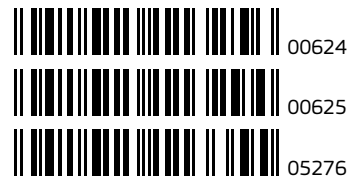

ΒΙΔΑ INOX ΦΡΕΖΑΤΗ ΣΤΑΥΡΟΥ M3 (DIN965)

Barcode	Icon	Code
00624	Φ 3x10 mm	1000
00625	Φ 3x12 mm	1000
05276	Φ 3x16 mm	1000



NEW ARRIVAL

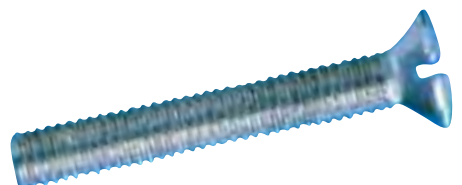

ΒΙΔΑ INOX ΦΡΕΖΑΤΗ ΣΤΑΥΡΟΥ M4 (DIN965)

Barcode	Icon	Code
05016	Φ 4x16 mm	1000
01892	Φ 4x20 mm	1000
14911	Φ 4x25 mm	500
09451	Φ 4x30 mm	200
14912	Φ 4x35 mm	500
06531	Φ 4x40 mm	500
06529	Φ 4x50 mm	500
06029	Φ 4x60 mm	500

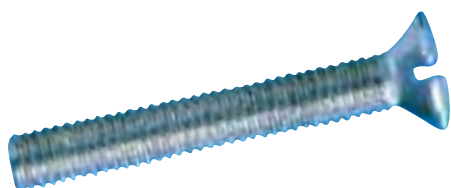
ΒΙΔΑ INOX ΦΡΕΖΑΤΗ ΣΤΑΥΡΟΥ M5 (DIN965)

Barcode	Spec	Qty
06539	Φ 5x20 mm	500
05872	Φ 5x30 mm	500
05873	Φ 5x35 mm	500
09479	Φ 5x40 mm	500
06540	Φ 5x50 mm	200
05883	Φ 5x60 mm	200
05875	Φ 5x70 mm	200

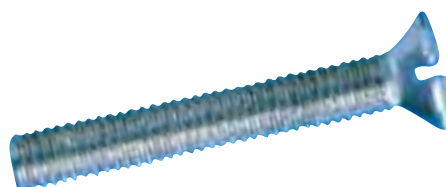
ΒΙΔΑ INOX ΦΡΕΖΑΤΗ ΣΤΑΥΡΟΥ M8 (DIN965)

Barcode	Spec	Qty
09807	Φ 8x20 mm	200
09808	Φ 8x30 mm	200
09809	Φ 8x40 mm	200
09810	Φ 8x50 mm	200
09811	Φ 8x60 mm	100
09812	Φ 8x70 mm	100
09813	Φ 8x80 mm	100
09814	Φ 8x90 mm	100
09815	Φ 8x100 mm	100

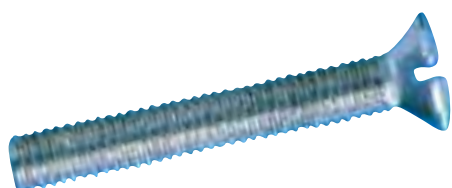
ΒΙΔΑ INOX ΦΡΕΖΑΤΗ ΣΤΑΥΡΟΥ M6 (DIN965)

Barcode	Spec	Qty
03831	Φ 6x16 mm	200
04852	Φ 6x20 mm	500
14909	Φ 6x25 mm	200
06532	Φ 6x30 mm	200
14864	Φ 6x35 mm	200
02347	Φ 6x40 mm	200
09480	Φ 6x50 mm	200
06536	Φ 6x60 mm	200
07056	Φ 6x70 mm	200
06537	Φ 6x80 mm	200
06109	Φ 6x90 mm	100
06538	Φ 6x100 mm	200

ΒΙΔΑ ΙΣΙΑ INOX M5 (DIN84)

Barcode	Spec	Qty
11364	Φ 5x16 mm	1000
11365	Φ 5x20 mm	500
11366	Φ 5x25 mm	500
11367	Φ 5x30 mm	500
11368	Φ 5x35 mm	500
11369	Φ 5x40 mm	500
11370	Φ 5x45 mm	200
11371	Φ 5x50 mm	200
11372	Φ 5x60 mm	200

	11373		14855
	11374		11379
	11375		11380
	11376		14857
	11377		14860
	11378		14603
	14602		14604
	14849		14661
	14850		14662



NEW ARRIVAL



ΒΙΔΑ ΣΤΑΥΡΟΥ INOX DIN 7985

11373	Ø 3x20 mm	1000
11374	Ø 3x25 mm	1000
11375	Ø 4x30 mm	500
11376	Ø 4x40 mm	500
11377	Ø 5x40 mm	500
11378	Ø 5x50 mm	200
14602	Ø 5x60 mm	200
14849	Ø 6x20 mm	500
14850	Ø 6x25 mm	200
14855	Ø 6x30 mm	200
11379	Ø 6x35 mm	200
11380	Ø 6x40 mm	200
14857	Ø 6x50 mm	200
14860	Ø 6x60 mm	200
14603	Ø 8x20 mm	200
14604	Ø 8x40 mm	200
14661	Ø 8x60 mm	100
14662	Ø 8x80 mm	100

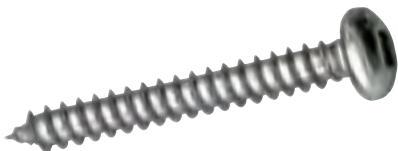

ΛΑΜΑΡΙΝΟΒΙΔΑ ΨΩΜΑΚΙ ΤΕΤΡΑΓΩΝΗ

07270	Ø 5.5x60 mm	250

	14663		14666
	14664		14667
	14665		14668



NEW ARRIVAL



ΛΑΜΑΡΙΝΟΒΙΔΑ ΦΡΕΖΑΤΗ INOX DIN 7982

14663	Ø 4,2x16 mm	1000
14664	Ø 4,2x19 mm	1000
14665	Ø 4,2x25 mm	1000
14666	Ø 4,2x32 mm	500
14667	Ø 4,2x38 mm	500
14668	Ø 4,2x50 mm	200

	13825		14673
	14669		14674
	14670		12119
	14671		13563
	14672		12120



NEW ARRIVAL



ΛΑΜΑΡΙΝΟΒΙΔΑ ΣΤΑΥΡΟΥ INOX DIN7981

13825	Ø 3,5x16 mm	2000
14669	Ø 4,2x16 mm	1000
14670	Ø 4,2x19 mm	1000
14671	Ø 4,2x25 mm	1000
14672	Ø 4,2x32 mm	500
14673	Ø 4,2x38 mm	500
14674	Ø 4,2x50 mm	200
12119	Ø 4,8x22 mm	1000
13563	Ø 5,5x30 mm	500
12120	Ø 5,5x50 mm	200

	03300		00750
	03672		00751
	00749		

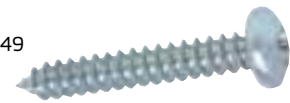

ΛΑΜΑΡΙΝΟΒΙΔΑ ΨΩΜΑΚΙ ΣΤΑΥΡΟΥ

03300	Ø 3,5x6 mm	1000
03672	Ø 3,5x12,5 mm	2000
00749	Ø 3,5x16 mm	1000
00750	Ø 3,5x19 mm	500
00751	Ø 3,5x25 mm	1000

	03978		00753
	02977		00754
	02641		00755
	00752		00756

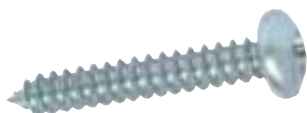
ΛΑΜΑΡΙΝΟΒΙΔΑ ΨΩΜΑΚΙ ΣΤΑΥΡΟΥ

03978	Φ 4,2x9,5 mm	1000
02977	Φ 4,2x12,5 mm	1000
02641	Φ 4,2x16 mm	1000
00752	Φ 4,2x19 mm	1000
00753	Φ 4,2x25 mm	1000
00754	Φ 4,2x32 mm	1000
00755	Φ 4,2x38 mm	1000
00756	Φ 4,2x50 mm	1000

	00757		00760
	00758		00761
	00759		

ΛΑΜΑΡΙΝΟΒΙΔΑ ΨΩΜΑΚΙ ΣΤΑΥΡΟΥ

00757	Φ 4,8x19 mm	1000
00758	Φ 4,8x25 mm	1000
00759	Φ 4,8x31 mm	200
00760	Φ 4,8x38 mm	500
00761	Φ 4,8x50 mm	500

	01547		00764
	00762		00765
	00763		03090

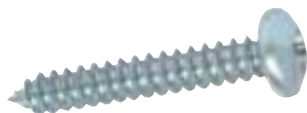
ΛΑΜΑΡΙΝΟΒΙΔΑ ΨΩΜΑΚΙ ΣΤΑΥΡΟΥ

01547	Φ 5,5x16 mm	1000
00762	Φ 5,5x25 mm	500
00763	Φ 5,5x31 mm	1000
00764	Φ 5,5x38 mm	700
00765	Φ 5,5x50 mm	200
03090	Φ 5,5x63 mm	200

	15617		15622
	15618		15623
	15619		15624
	15620		15625
	15621		15626

NEW ARRIVAL

ΒΙΔΑ TORX ΞΥΛΟΥ ΚΙΡΙΝΗ T30

15617	Φ 6x40 mm	100
15618	Φ 6x50 mm	100
15619	Φ 6x60 mm	100
15620	Φ 6x80 mm	100
15621	Φ 6x100 mm	100
15622	Φ 6x120 mm	100
15623	Φ 6x140 mm	100
15624	Φ 6x160 mm	100
15625	Φ 6x180 mm	100
15626	Φ 6x200 mm	100

	15627		15631
	15628		15632
	15629		15633
	15630		

NEW ARRIVAL

ΒΙΔΑ TORX ΞΥΛΟΥ ΚΙΡΙΝΗ T40

15627	Φ 8x80 mm	50
15628	Φ 8x100 mm	50
15629	Φ 8x120 mm	50
15630	Φ 8x140 mm	50
15631	Φ 8x160 mm	50
15632	Φ 8x180 mm	50
15633	Φ 8x200 mm	50

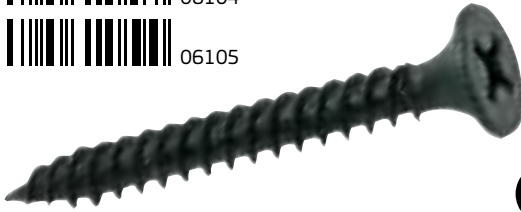
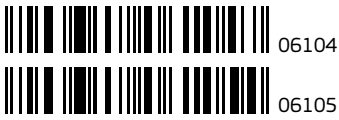

ΒΙΔΑ ΜΑΥΡΗ ΓΥΦΟΣΑΝΙΔΑΣ

Barcode	Icon	Quantity
06104	Φ 3,5x25 mm	1000
06105	Φ 3,5x35 mm	1000

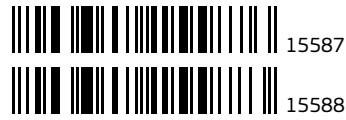

NEW ARRIVAL



ΒΙΔΑ ΓΥΦΟΣΑΝΙΔΑΣ ΜΑΥΡΗ (ΤΡΥΠΑΝΙ)

Barcode	Icon	Quantity
15587	Φ 3,5x25 mm	1000
15588	Φ 3,5x35 mm	1000



ΚΑΣΟΝΟΒΙΔΑ ΓΑΛΒΑΝΙΖΕ Μ6

Barcode	Icon	Quantity
03935	Φ 6x15 mm	300
00478	Φ 6x20 mm	500
03912	Φ 6x25 mm	300
02051	Φ 6x30 mm	200
00836	Φ 6x40 mm	500
01727	Φ 6x50 mm	200
01846	Φ 6x60 mm	200
01456	Φ 6x70 mm	200
00130	Φ 6x80 mm	270
06139	Φ 6x90 mm	100
06865	Φ 6x100 mm	100

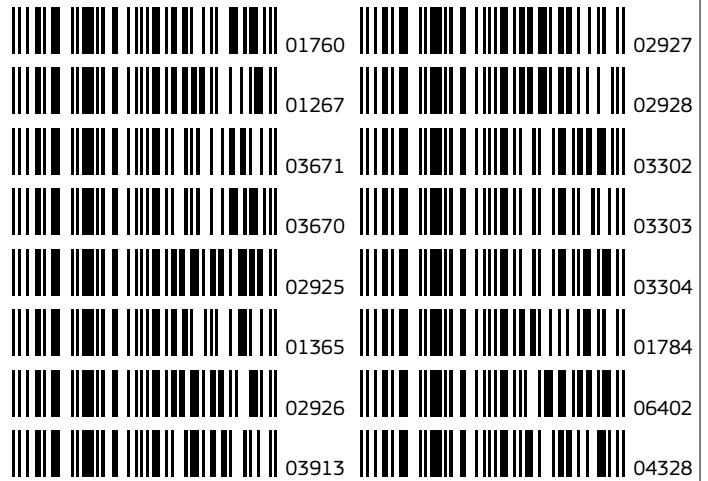

ΚΑΣΟΝΟΒΙΔΑ ΓΑΛΒΑΝΙΖΕ Μ8

Barcode	Icon	Quantity
01760	Φ 8x30 mm	200
01267	Φ 8x35 mm	350
03671	Φ 8x40 mm	200
03670	Φ 8x50 mm	200
02925	Φ 8x60 mm	100
01365	Φ 8x70 mm	100
02926	Φ 8x80 mm	100
03913	Φ 8x90 mm	100
02927	Φ 8x100 mm	100
02928	Φ 8x120 mm	100
03302	Φ 8x130 mm	100
03303	Φ 8x140 mm	40
03304	Φ 8x150 mm	50
01784	Φ 8x160 mm	50
06402	Φ 8x180 mm	50
04328	Φ 8x200 mm	50

	03914		02999
	03915		03000
	03916		01895
	03917		03001
	03918		05411
	02998		05156
	02929		04329
	02930		05410
	05777		04330

**ΚΑΣΟΝΟΒΙΔΑ ΓΑΛΒΑΝΙΖΕ M10**

03914	Φ 10x50 mm	50
03915	Φ 10x60 mm	50
03916	Φ 10x70 mm	110
03917	Φ 10x80 mm	100
03918	Φ 10x90 mm	100
02998	Φ 10x100 mm	50
02929	Φ 10x110 mm	80
02930	Φ 10x120 mm	50
05777	Φ 10x140 mm	50
02999	Φ 10x150 mm	100
03000	Φ 10x160 mm	50
01895	Φ 10x180 mm	50
03001	Φ 10x200 mm	50
05411	Φ 10x220 mm	25
05156	Φ 10x240 mm	25
04329	Φ 10x260 mm	25
05410	Φ 10x280 mm	25
04330	Φ 10x300 mm	20

	07739		04023
	01252		06859
	06861		06627
	04034		06860
	04035		05155







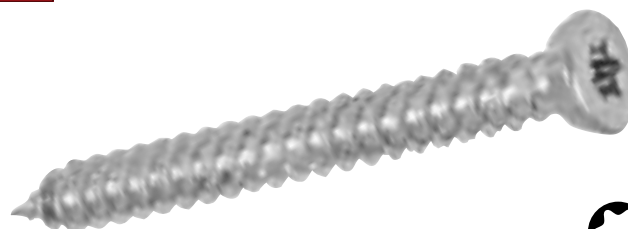







**ΚΑΣΟΝΟΒΙΔΑ ΓΑΛΒΑΝΙΖΕ M12**

07739	Φ 12x80 mm	100
01252	Φ 12x120 mm	50
06861	Φ 12x140 mm	50
04034	Φ 12x160 mm	50
04035	Φ 12x180 mm	25
04023	Φ 12x200 mm	25
06859	Φ 12x240 mm	25
06627	Φ 12x260 mm	50
06860	Φ 12x280 mm	25
05155	Φ 12x300 mm	25

	04240		04243
	04241		04244
	04242		04245



**ΤΣΙΜΕΝΟΒΙΔΑ**

04240	Φ 7,5x72 mm	100
04241	Φ 7,5x92 mm	100
04242	Φ 7,5x112 mm	100
04243	Φ 7,5x132 mm	100
04244	Φ 7,5x152 mm	100
04245	Φ 7,5x182 mm	100

	13827		13921
	13904		13922
	12117		13923
	13905		14676
	13906		14677
	15309		14678
	14675		11484
	13920		



ΚΑΣΟΝΟΒΙΔΑ ΙΝΟΧ

		
13827	Φ 6x30 mm	00
13904	Φ 6x50 mm	200
12117	Φ 6x60 mm	200
13905	Φ 6x70 mm	100
13906	Φ 6x80 mm	100
15309	Φ 6x100 mm	100
14675	Φ 8x40 mm	100
13920	Φ 8x50 mm	100
13921	Φ 8x60 mm	100
13922	Φ 8x70 mm	100
13923	Φ 8x80 mm	50
14676	Φ 10x40 mm	100
14677	Φ 10x60 mm	50
14678	Φ 10x80 mm	50
11484	Φ 10x120 mm	50

	10138		02608
	01876		00960
	03961		02737
	08494		00224
	02732		02738
	10139		04237
	10140		02740
	02733		15349
	03540		



LIH-LIN

GET IT NOW

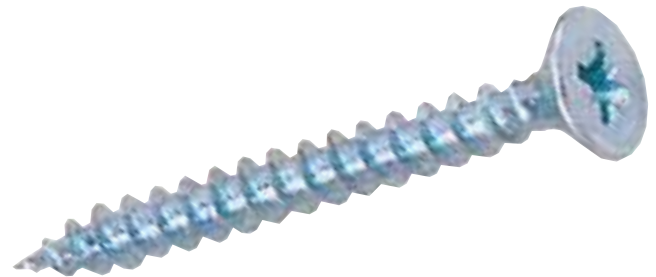
HOT SELLER



ΝΟΒΟΠΑΝΟΒΙΔΑ ΓΑΛΒΑΝΙΖΕ 3 & 3,5 mm

		
10138	Φ 3x12 mm	1000
01876	Φ 3x16 mm	1000
03961	Φ 3x20 mm	1000
08494	Φ 3x25 mm	1000
02732	Φ 3x30 mm	1000
10139	Φ 3x35 mm	1000
10140	Φ 3x40 mm	1000
02733	Φ 3,5x16 mm	1000
03540	Φ 3,5x18 mm	1000
02608	Φ 3,5x20 mm	1000
00960	Φ 3,5x25 mm	1000
02737	Φ 3,5x30 mm	1000
00224	Φ 3,5x35 mm	1000
02738	Φ 3,5x40 mm	1000
04237	Φ 3,5x45 mm	1000
02740	Φ 3,5x50 mm	1000
15349	Φ 3,5x60 mm	1000

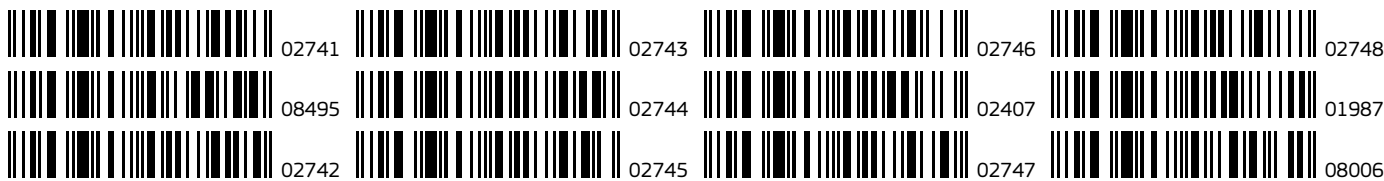

LIH-LIN

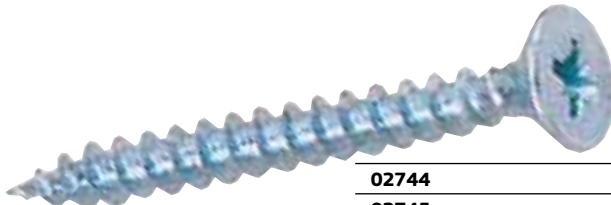

ΝΟΒΟΠΑΝΟΒΙΔΑ ΓΑΛΒΑΝΙΖΕ 4 mm

Barcode	Icon	Code
02741	Φ 4x16 mm	1000
08495	Φ 4x18 mm	1000
02742	Φ 4x20 mm	1000
02743	Φ 4x25 mm	1000

02744	Φ 4x30 mm	1000
02745	Φ 4x35 mm	1000
02746	Φ 4x40 mm	1000
02407	Φ 4x45 mm	1000
02747	Φ 4x50 mm	500
02748	Φ 4x60 mm	500
01987	Φ 4x70 mm	400
08006	Φ 4x80 mm	400

HOT
SELLER

GET IT
NOW



LIH-LIN

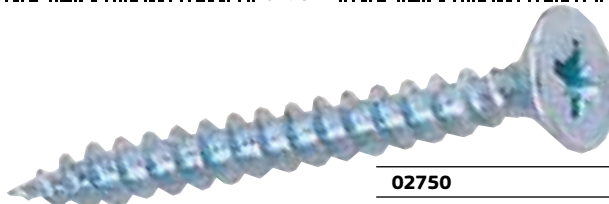

ΝΟΒΟΠΑΝΟΒΙΔΑ ΓΑΛΒΑΝΙΖΕ 5 mm

Barcode	Icon	Code
10000	Φ 5x20 mm	1000
08496	Φ 5x25 mm	1000
02749	Φ 5x30 mm	1000
00231	Φ 5x35 mm	1000

02750	Φ 5x40 mm	500
02751	Φ 5x50 mm	500
01548	Φ 5x60 mm	400
02753	Φ 5x70 mm	250
02754	Φ 5x80 mm	250
04238	Φ 5x90 mm	200
02755	Φ 5x100 mm	200
02756	Φ 5x120 mm	200

HOT
SELLER

GET IT
NOW



LIH-LIN

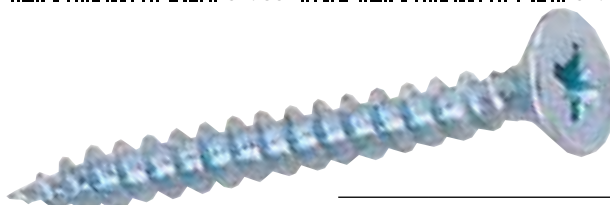

ΝΟΒΟΠΑΝΟΒΙΔΑ ΓΑΛΒΑΝΙΖΕ 6 mm

Barcode	Icon	Code
10141	Φ 6x30 mm	500
08497	Φ 6x40 mm	500
02757	Φ 6x50 mm	250
02758	Φ 6x60 mm	250

02759	Φ 6x70 mm	250
02760	Φ 6x80 mm	200
02761	Φ 6x90 mm	200
02762	Φ 6x100 mm	200
02763	Φ 6x120 mm	100
03477	Φ 6x140 mm	100
10142	Φ 6x150 mm	100

GET IT
NOW

ΝΟΒΟΠΑΝΟΒΙΔΑ ΙΝΟΧ

 13409	 05856	 15201	 14867
 15312	 04974	 13263	 14868
 07022	 14515	 13411	 13264
 10614	 06587	 13941	 09877
 10615	 14861	 14517	 03472
 12798	 06025	 12799	 04805
 13826	 14516	 09876	 06179
 10616	 06588	 11977	 12063
 10617	 07020	 05722	 11477
 10618	 11023	 06595	 13410
 10619	 10620	 07023	 14869
 14866	 10621	 10623	
 13282	 10622	 12062	

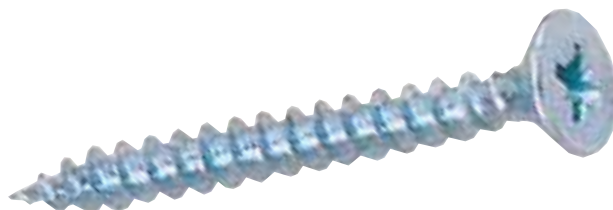

ΝΟΒΟΠΑΝΟΒΙΔΑ ΙΝΟΧ

		
13409	Φ 3x16 mm	1000
15312	Φ 3x20 mm	1000
07022	Φ 3x25 mm	1000
10614	Φ 3x30 mm	1000
10615	Φ 3x40 mm	1000
12798	Φ 3,5x16 mm	1000
13826	Φ 3,5x20 mm	1000
10616	Φ 3,5x25 mm	1000
10617	Φ 3,5x30 mm	1000
10618	Φ 3,5x35 mm	1000
10619	Φ 3,5x40 mm	1000
14866	Φ 3,5x45 mm	1000
13282	Φ 3,5x50 mm	1000
05856	Φ 4x16 mm	500
04974	Φ 4x20 mm	500
14515	Φ 4x25 mm	500
06587	Φ 4x30 mm	500
14861	Φ 4x35 mm	500
06025	Φ 4x40 mm	500
14516	Φ 4x45 mm	500
06588	Φ 4x50 mm	500
07020	Φ 4x60 mm	500
11023	Φ 4x70 mm	500
10620	Φ 4,5x20 mm	500
10621	Φ 4,5x25 mm	500

10622	Φ 4,5x30 mm	500
15201	Φ 4,5x35 mm	500
13263	Φ 4,5x40 mm	200
13411	Φ 4,5x50 mm	200
13941	Φ 4,5x60 mm	200
14517	Φ 5x20 mm	500
12799	Φ 5x25 mm	500
09876	Φ 5x30 mm	500
11977	Φ 5x35 mm	500
05722	Φ 5x40 mm	200
06595	Φ 5x50 mm	200
07023	Φ 5x60 mm	200
10623	Φ 5x70 mm	100
12062	Φ 5x80 mm	100
14867	Φ 5x100 mm	100
14868	Φ 5x120 mm	100
13264	Φ 6x20 mm	200
09877	Φ 6x30 mm	500
03472	Φ 6x40 mm	200
04805	Φ 6x50 mm	200
06179	Φ 6x60 mm	200
12063	Φ 6x70 mm	100
11477	Φ 6x80 mm	100
13410	Φ 6x100 mm	100
14869	Φ 6x120 mm	100

	10143		01996
	00954		06654
	10144		00941
	10145		10148
	10146		11308
	10147		01117
	02597		

LIH-LIN



ΝΟΒΟΠΑΝΟΒΙΔΑ ΚΙΤΡΙΝΗ

10143	Φ 3x16 mm	1000
00954	Φ 3x20 mm	1000
10144	Φ 3x30 mm	1000
10145	Φ 3,5x16 mm	1000
10146	Φ 3,5x20 mm	1000
10147	Φ 3,5x25 mm	1000
02597	Φ 3,5x30 mm	1000
01996	Φ 3,5x40 mm	1000
06654	Φ 4x20 mm	1000
00941	Φ 4x25 mm	1000
10148	Φ 4x30 mm	1000
11308	Φ 5x30 mm	1000
01117	Φ 5x35 mm	1000

	00225
	00228

LIH-LIN



ΝΟΒΟΠΑΝΟΒΙΔΑ ΜΑΥΡΗ

00225	Φ 5x30 mm	1000
00228	Φ 5x35 mm	1000

	10703
	10704
	10705

LIH-LIN

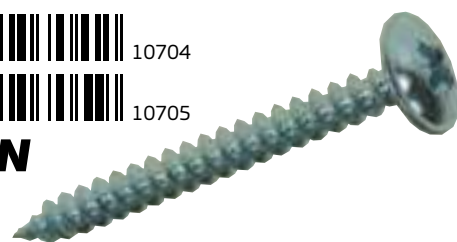

ΝΟΒΟΠΑΝΟΒΙΔΑ ΜΕ ΡΟΔΕΛΑ

10703	Φ 6x50 mm	250
10704	Φ 6x60 mm	250
10705	Φ 6x70 mm	250

	05770
	05772



ΤΡΥΠΑΝΟΒΙΔΑ ΑΠΛΗ ΤΑΪΒΑΝ

05770	Φ 4,2x13 mm	1000
05772	Φ 4,2x25 mm	1000

	02982		00357
	02983		01292
	02984		03159
	02985		06698

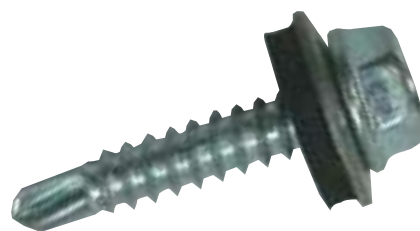

**HOT
SELLER**

ΤΡΥΠΑΝΟΒΙΔΑ ΜΕ ΡΟΔΕΛΑ 7504 K

02982	Φ 6,3x25 mm	500
02983	Φ 6,3x32 mm	400
02984	Φ 6,3x38 mm	400
02985	Φ 6,3x50 mm	300
00357	Φ 6,3x60 mm	300
01292	Φ 6,3x75 mm	120
03159	Φ 6,3x100 mm	150
06698	Φ 6,3x125 mm	100

	02345		03260
	00839		03262
	02900		03306
	00595		03307
	00472		14680
	02222		14681
	01381		14682
	02883		14683
	03259		14684

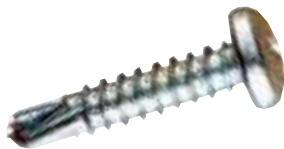

ΤΡΥΠΑΝΟΒΙΔΑ ΨΩΜΑΚΙ 7504 N

02345	Φ 3,5x16 mm	500
00839	Φ 3,5x19 mm	1000
02900	Φ 3,5x25 mm	1000
00595	Φ 3,5x38 mm	500
00472	Φ 3,5x50 mm	500
02222	Φ 3,5x60 mm	500
01381	Φ 4,2x16 mm	800
02883	Φ 4,2x19 mm	1000
03259	Φ 4,2x25 mm	500
03260	Φ 4,2x32 mm	300
03262	Φ 4,2x38 mm	200
03306	Φ 4,2x50 mm	1000
03307	Φ 4,2x60 mm	1000
14680	Φ 4,8x19 mm	500
14681	Φ 4,8x25 mm	350
14682	Φ 4,8x32 mm	1000
14683	Φ 4,8x38 mm	1000
14684	Φ 4,8x50 mm	500



ΡΟΔΕΛΑ ΤΡΥΠΑΝΟΒΙΔΑΣ

00282	Φ 6 mm - 14x16 mm	1000

	03308		02481
	02538		02090
	03405		01999
	03037		02056
	02269		01323
	02532		00287
	02531		01889



ΤΡΥΠΑΝΟΒΙΔΑ ΦΡΕΖΑΤΗ 7504 P

03308	Φ 3,5x16 mm	500
02538	Φ 3,5x19 mm	1000
03405	Φ 3,5x25 mm	1000
03037	Φ 3,5x32 mm	500
02269	Φ 3,5x38 mm	1000
02532	Φ 3,5x50 mm	1000
02531	Φ 3,5x63 mm	900
02481	Φ 4,2x16 mm	1000
02090	Φ 4,2x19 mm	800
01999	Φ 4,2x25 mm	1000
02056	Φ 4,2x32 mm	1000
01323	Φ 4,2x38 mm	1000
00287	Φ 4,2x50 mm	500
01889	Φ 4,2x63 mm	100

	06617		06618
	09406		11629
	07060		11630



GET IT NOW

ΤΡΥΠΑΝΟΒΙΔΑ ΡΟΔΕΛΑ TRUSS (WAFER) DIN 7504 K

06617	Φ 4,2x13 mm	1500
09406	Φ 4,2x16 mm	1000
07060	Φ 4,2x19 mm	1000
06618	Φ 4,2x25 mm	400
11629	Φ 4,2x32 mm	1000
11630	Φ 4,2x38 mm	1000



ΑΓΚΙΣΤΡΑ ΜΕ ΠΑΞΙΜΑΔΙΑ

Barcode	Product Code	Quantity
04820	6x10 mm (M x μήκος)	500
02236	6x12,5 mm (M x μήκος)	500
00375	6x14,5 mm (M x μήκος)	500
02147	6x17 mm (M x μήκος)	500
01506	8x12,5 mm (M x μήκος)	500
01207	8x14,5 mm (M x μήκος)	500
07401	8x17 mm (M x μήκος)	450



ΚΑΛΥΠΤΡΑ Φ 6 mm ΤΡΑΠΕΖΟΕΙΔΗΣ

Barcode	Product Code	Quantity
02301	γαλβανιζέ	1000
05257	κόκκινη	1000
14744	μπεζ	1000
14573	Ροδέλα στενή (άνω) Φ 6,5mm - Άσπρη	8000
04989	Ροδέλα στενή (κάτω) Φ 6,0mm - Μαύρη	2Kg

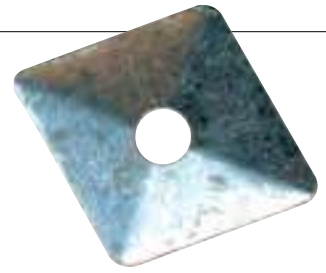

ΠΛΑΚΕΤΑ ΜΕΤΑΛΛΙΚΗ

Barcode	Product Code	Quantity
00283	Φ 8 mm	500



ΚΑΠΕΛΑΚΙ ΣΤΡΙΦΩΝΙΩΝ

Barcode	Product Code	Quantity
01442	Φ 8 mm	100



09736



15270



09737



NEW ARRIVAL

ΣΤΡΙΦΩΝΙ ΜΕ ΡΟΔΕΛΑ ΜΕ ΓΑΛΒΑΝΙΖΕ ΚΕΦΑΛΙ

Barcode	Product Code	Quantity
09736	Φ 6x60 mm	200
15270	Φ 6x70 mm	200
09737	Φ 6x80 mm	200



09738



09739



09740



ΣΤΡΙΦΩΝΙ ΜΕ ΡΟΔΕΛΑ ΜΕ ΚΟΚΚΙΝΟ ΚΕΦΑΛΙ

Barcode	Product Code	Quantity
09738	Φ 6x60 mm	200
09739	Φ 6x70 mm	200
09740	Φ 6x80 mm	200
09741	Φ 6x100 mm	200
09742	Φ 6x120 mm	100

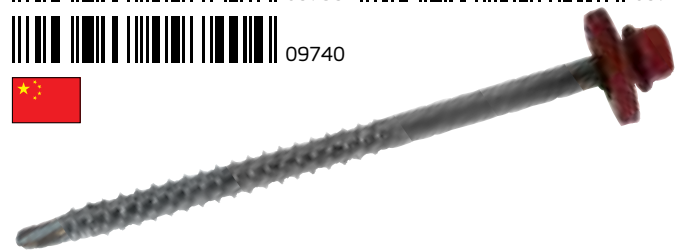



NEW
ARRIVAL

ΣΤΡΙΦΩΝΙ ΜΕ ΡΟΔΕΛΑ ΓΑΛΒΑΝΙΖΕ ΜΕ ΣΧΙΣΜΗ T17

Barcode	Icon	Icon
14432	Φ 6x60 mm	200
14433	Φ 6x80 mm	200
14434	Φ 6x100 mm	200
14435	Φ 6x120 mm	100
14438	Φ 6x140 mm	100



ΣΤΡΙΦΩΝΙ ΓΑΛΒΑΝΙΖΕ M6 (DIN571)

Barcode	Icon	Icon
03583	Φ 6x35 mm	500
02703	Φ 6x40 mm	300
02704	Φ 6x50 mm	200
02705	Φ 6x60 mm	200
02706	Φ 6x70 mm	200
02707	Φ 6x80 mm	200
02708	Φ 6x90 mm	175
02709	Φ 6x100 mm	200
03476	Φ 6x120 mm	200



NEW
ARRIVAL

ΣΤΡΙΦΩΝΙ ΜΕ ΡΟΔΕΛΑ ΚΟΚΚΙΝΟ ΜΕ ΣΧΙΣΜΗ T17 (RAL3013)

Barcode	Icon	Icon
14440	Φ 6x60 mm	200
14441	Φ 6x80 mm	200
14443	Φ 6x100 mm	200
14444	Φ 6x120 mm	200
14445	Φ 6x140 mm	100



NEW
ARRIVAL

ΜΠΟΥΖΟΝΟΣΤΡΙΦΩΝΑ ΓΑΛΒΑΝΙΖΕ

Barcode	Icon	Icon
15589	Φ 6x60mm	200
15590	Φ 6x80mm	100
15591	Φ 8x60mm	100
15592	Φ 8x80mm	100
15593	Φ 8x100mm	100

	04835		02717
	00440		03620
	02712		02719
	02711		03623
	02713		02720
	02714		00363
	02715		04548
	02716		

GET IT NOW



ΣΤΡΙΦΩΝΙ ΓΑΛΒΑΝΙΖΕ M8 (DIN571)

04835	Φ 8x30 mm	100
00440	Φ 8x40 mm	200
02712	Φ 8x50 mm	100
02711	Φ 8x60 mm	200
02713	Φ 8x70 mm	100
02714	Φ 8x80 mm	100
02715	Φ 8x90 mm	100
02716	Φ 8x100 mm	100
02717	Φ 8x120 mm	100
03620	Φ 8x130 mm	50
02719	Φ 8x140 mm	50
03623	Φ 8x150 mm	75
02720	Φ 8x160 mm	100
00363	Φ 8x180 mm	100
04548	Φ 8x200 mm	100

	02721		02728
	02722		00871
	02723		00872
	02724		04627
	01930		04628
	02725		05867
	02726		06187
	02727		
	03621		



ΣΤΡΙΦΩΝΙ ΓΑΛΒΑΝΙΖΕ M10 (DIN571)

02721	Φ 10x50 mm	60
02722	Φ 10x60 mm	100
02723	Φ 10x70 mm	80
02724	Φ 10x80 mm	100
01930	Φ 10x90 mm	100
02725	Φ 10x100 mm	100
02726	Φ 10x120 mm	100
02727	Φ 10x140 mm	50
03621	Φ 10x150 mm	50
02728	Φ 10x160 mm	50
00871	Φ 10x180 mm	50
00872	Φ 10x200 mm	50
04627	Φ 10x240 mm	50
04628	Φ 10x260 mm	25
05867	Φ 10x280 mm	25
06187	Φ 10x300 mm	25

	05861		05645
	05862		06433
	05860		06434



ΣΤΡΙΦΩΝΙ ΓΑΛΒΑΝΙΖΕ M12 (DIN571)

05861	Φ 12x90 mm	50



05862	Φ 12x100 mm	50
05860	Φ 12x120 mm	50
05645	Φ 12x140 mm	50
06433	Φ 12x160 mm	50
06434	Φ 12x180 mm	25

	13592		06079
	10624		10630
	13593		10631
	12797		08797
	10625		08798
	10626		13836
	10627		15202
	10628		10632
	13594		10633
	10629		13837
	06076		13838
	06078		10516
	05721		13604
	06077		



ΣΤΡΙΦΩΝΙΑ ΙΝΟΧ

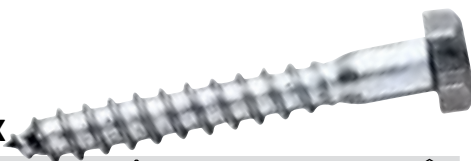

13592	Φ 6x30 mm	100
10624	Φ 6x40 mm	100
13593	Φ 6x50 mm	100
12797	Φ 6x60 mm	100
10625	Φ 6x70 mm	100
10626	Φ 6x80 mm	100
10627	Φ 6x100 mm	100
10628	Φ 6x120 mm	100
13594	Φ 8x30 mm	100
10629	Φ 8x40 mm	100
06076	Φ 8x50 mm	100
06078	Φ 8x60 mm	100
05721	Φ 8x70 mm	100
06077	Φ 8x80 mm	100
06079	Φ 8x100 mm	100
10630	Φ 8x120 mm	50
10631	Φ 8x140 mm	50
08797	Φ 8x180 mm	50
08798	Φ 8x200 mm	50
13836	Φ 10x40 mm	100
15202	Φ 10x50 mm	100
10632	Φ 10x60 mm	100
10633	Φ 10x70 mm	100
13837	Φ 10x80 mm	100
13838	Φ 10x100 mm	100
10516	Φ 10x120 mm	50
13604	Φ 12x60 mm	50

	05404		05625
	05405		05514
	05378		05406



ΧΑΛΚΑΣ ΣΤΡΙΦΩΝΙΑ ΚΙΝΗΤΟ

05404	18 - 25	100
05405	19 - 30	100
05378	20 - 25	100
05625	21 - 35	100
05514	22 - 30	100
05406	22 - 35	100

	03593
	01779
	02371
	00874



ΧΑΛΚΑΣ ΣΤΡΙΦΩΝΙΑ ΚΙΝΗΤΟ

03593	3/16"	100
01779	1/4"	50
02371	5/16"	50
00874	3/8"	30

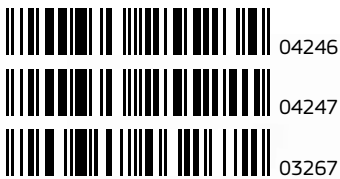

04246

04247

03267



ΧΑΛΚΑΣ ΣΤΡΙΦΩΝΙ ΣΤΑΘΕΡΟ

Barcode	Head	Quantity
04246	1/4"	100
04247	5/16"	50
03267	3/8"	50

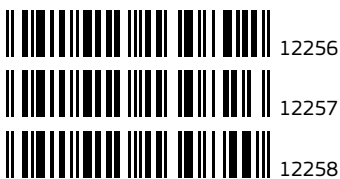

12256

12257

12258



ΧΑΛΚΑΣ ΣΤΡΙΦΩΝΙ ΣΤΑΘΕΡΟ ΙΝΟΧ

Barcode	Head	Quantity
12256	∅ 5x50 mm	10
12257	∅ 6x60 mm	10
12258	∅ 8x80 mm	10

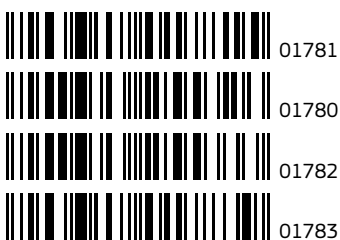

01781

01780

01782

01783



ΧΑΛΚΑΣ ΠΑΞΙΜΑΔΙ ΛΟΥΚΕΤΟ

Barcode	Head	Quantity
01781	3/16"	100
01780	1/4"	100
01782	5/16"	50
01783	3/8"	25



05642

05375

05400

05394

05401

05381

05513

05395

05402

05396

05897

15305

05386

05398

07455

05399

05392

07456

05380

08850

05393

08765

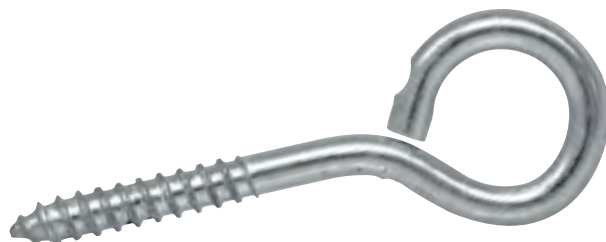

ΒΙΔΟΘΗΛΙΑ ΓΑΛΒΑΝΙΖΕ

Barcode	Head	Quantity
05642	14x35	700
05400	16x30	700
05401	16x40	500
05513	17x50	300
05402	18x50	300
05897	18x60	200
05386	19x60	200
07455	19x70	200
05392	20x80	200
05380	20x100	200
05393	21x100	200
05375	22x80	200
05394	22x120	200
05381	22x155	150
05395	23x90	150
05396	23x125	150
15305	23x140	100
05398	23x165	100
05399	24x110	100
07456	25x100	100
08850	25x120	100
08765	26x145	75

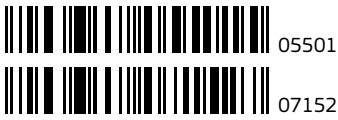

05501



07152



ΒΙΔΟΘΗΛΙΑ ΜΕΤΡΙΚΟΥ ΣΠΕΙΡΩΜΑΤΟΣ

Barcode	Icon	Icon
05501	Φ 6x50 mm	100
07152	Φ 8x65 mm	100

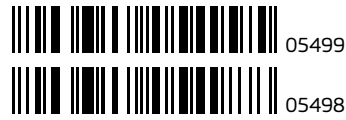

05499



05498



ΓΑΝΤΖΟΣ ΜΕΤΡΙΚΟΥ ΣΠΕΙΡΩΜΑΤΟΣ

Barcode	Icon	Icon
05499	Φ 6x50 mm	100
05498	Φ 8x65 mm	100



ΓΑΝΤΖΟΣ ΓΑΛΒΑΝΙΖΕ

Barcode	Icon	Icon
05363	16x40	500
05364	17x60	200
05365	17x70	200
05641	18x60	200
07462	18x70	200
05366	18x80	200
06663	18x100	200
08851	19x80	200
05336	19x100	200
08852	20x65	200
05512	20x75	200
05434	20x95	200
05367	20x110	200
05433	21x90	200



07463	21x100	200
05511	22x100	200
05338	22x130	150
15356	22x160	100
05359	23x120	150
15357	23x140	100
05749	23x160	100
05368	23x170	100
05432	23x180	100
05339	23x210	100
05337	25x130	100
11257	25x160	75
11258	26x145	75

	05370		05373
	05371		00149
	01460		05335
	00135		07459
	05593		07460
	00182		05374
	01462		05616
	02599		07461
	07457		05369
	06967		09443
	07458		05312
	05372		05775



ΣΤΡΑΒΟΚΑΡΦΟ ΒΙΔΑ

05370	14x30	700
05371	16x40	500
01460	18x40	300
00135	18x50	300
05593	18x60	200
00182	20x40	300
01462	20x50	200
02599	20x60	200
07457	20x70	200
06967	20x80	200
07458	21x50	200
05372	21x60	200
05373	21x70	200
00149	21x80	200
05335	21x100	200
07459	22x50	200
07460	22x60	200
05374	22x70	200
05616	22x80	200
07461	22x100	200
05369	23x75	200
09443	23x120	150
05312	24x90	100
05775	26x120	50

	14786
	14787
	14788



NEW ARRIVAL

ΑΣΦΑΛΕΙΕΣ ΑΡΟΤΡΟΥ

14786	6 mm	50
14787	8 mm	50
14788	10 mm	50

	14789		14792
	14790		14793
	14791		



NEW ARRIVAL

ΠΕΡΟΝΕΣ ΑΡΟΤΡΟΥ

14789	3x65 mm	100
14790	4x75 mm	100
14791	5x100 mm	50
14792	7x120 mm	50
14793	9x155 mm	10

	00439
	02035



ΟΥΠΑ ΓΑΝΤΖΟ ΜΕΤΑΛΛΙΚΟ ΒΑΡΕΩΣ ΤΥΠΟΥ

00439	6 mm	100
02035	8 mm	30

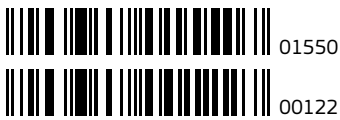

ΟΥΠΑ ΘΗΛΙΑ ΜΕΤΑΛΛΙΚΟ ΒΑΡΕΩΣ ΤΥΠΟΥ

Barcode	Icon	Quantity
01550	6 mm	60
00122	8 mm	30



ΟΥΠΑ ΜΕΤΑΛΛΙΚΟ ΜΕ ΒΙΔΑ

Barcode	Icon	Quantity
00701	Φ 6x50 mm	100
01159	Φ 8x65 mm	50
02010	Φ 10x70 mm	30
02013	Φ 12x90 mm	15



ΟΥΠΑ ΜΕΤΑΛΛΙΚΟ ΧΩΡΙΣ ΒΙΔΑ

Barcode	Icon	Quantity
11331	Φ 6x40 mm	100
11332	Φ 8x50 mm	50
11333	Φ 10x60 mm	50
11334	Φ 12x80 mm	25

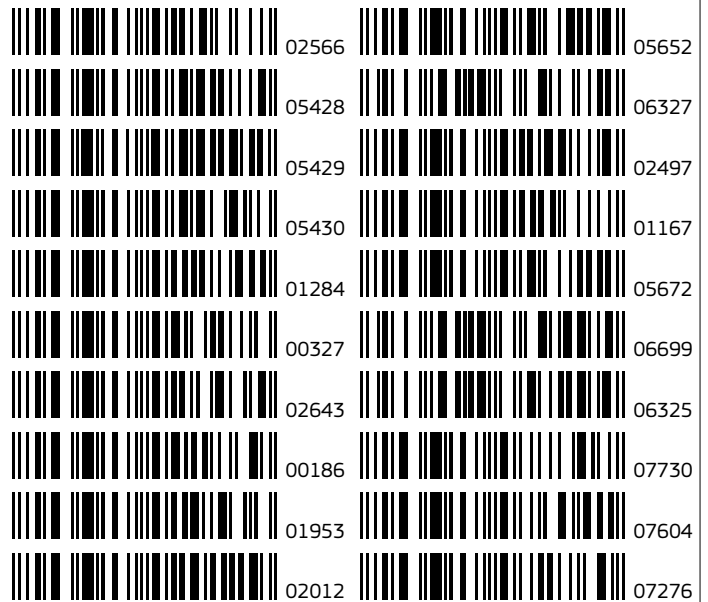

ΟΥΠΑ ΜΠΗΧΤΟ EXPRESS

Barcode	Icon	Quantity
02566	Φ 6x55 mm	200
05428	Φ 6x70 mm	200
05429	Φ 6x95 mm	100
05430	Φ 8x60 mm	150
01284	Φ 8x75 mm	150
00327	Φ 8x100 mm	100
02643	Φ 8x115 mm	75
00186	Φ 10x80 mm	85
01953	Φ 10x95 mm	75
02012	Φ 10x120 mm	60
05652	Φ 10x150 mm	50
06327	Φ 10x180 mm	30
02497	Φ 12x100 mm	35
01167	Φ 12x135 mm	45
05672	Φ 12x160 mm	25
06699	Φ 12x180 mm	25
06325	Φ 12x220 mm	15
07730	Φ 14x145 mm	25
07604	Φ 16x125 mm	30
07276	Φ 16x140 mm	25



ΟΥΠΑ ΝΕΟΥ ΤΥΠΟΥ ΜΕ ΡΟΔΕΛΑ ΛΕΥΚΟ

Barcode	Icon	Quantity
13037	Φ 6x37 mm	100
13038	Φ 8x52 mm	100
13039	Φ 10x62 mm	50
13040	Φ 12x72 mm	25

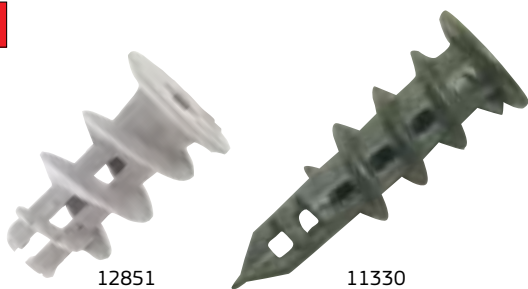
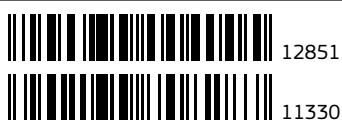

ΟΥΠΑ ΓΥΦΟΣΑΝΙΔΑΣ ΚΟΧΛΙΑΣ

Barcode	Icon	Quantity
12851	πλαστικό 13x32	100
11330	μεταλλικό 15x29	100



ΟΥΠΑ ΓΥΦΟΣΑΝΙΔΟΣ

Barcode	Icon	Quantity
03816	Φ 6x40 mm	100
02472	Φ 6x55 mm	100
03817	Φ 6x70 mm	50
03818	Φ 8x60 mm	50
03819	Φ 8x75 mm	50
00841	Φ 8x100 mm	50



**HOT
SELLER**

**GET IT
NOW**

ΟΥΠΑ ΠΛΑΣΤΙΚΟ

Barcode	Icon	Quantity
00982	Φ 5 mm (100τμχ)	10
00983	Φ 6 mm (100τμχ)	10
00984	Φ 7 mm (100τμχ)	10
00985	Φ 8 mm (100τμχ)	10
00986	Φ 10 mm (50τμχ)	10
00987	Φ 12 mm (25τμχ)	10
00988	Φ 14 mm (20τμχ)	10

13041
13042



ΟΥΠΑ ΘΕΡΜΟΜΟΝΩΤΙΚΩΝ ΠΛΑΚΩΝ ΜΕ ΚΑΡΦΙ

Barcode	Icon	Icon
13041	(Φ x μήκος) 10x90 mm	00
13042	(Φ x μήκος) 10x110 mm	00



09171

ΟΥΠΑ ΓΥΨΟΣΑΝΙΔΑΣ ΣΠΑΣΤΟ ΠΛΑΣΤΙΚΟ

Barcode	Icon	Icon
09171	Φ 10 mm	100

02106
01688

ΠΑΞΙΜΑΔΙ ΓΑΛΒΑΝΙΖΕ ΙΝΤΣΑΣ

Barcode	Icon	Icon
02106	M ¼"	500
01688	M ⅜"	200

03305 03112
04253 03113
02948 02965
03110 02934
03111 05468
02836 03716



GET IT NOW



ΠΑΞΙΜΑΔΙ ΓΑΛΒΑΝΙΖΕ DIN934

Barcode	Icon	Icon
03305	M 4 mm	2000
04253	M 5 mm	1000
02948	M 6 mm	1200
03110	M 8 mm	500
03111	M 10 mm	250
02836	M 12 mm	150
03112	M 14 mm	100
03113	M 16 mm	100
02965	M 18 mm	50
02934	M 20 mm	50
05468	M 22 mm	40
03716	M 24 mm	25



	05648		07327
	05649		07248
	05650		07249
	06095		07328

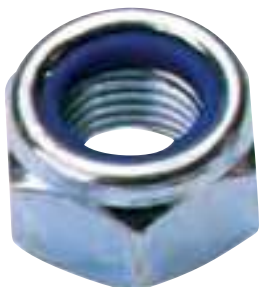

ΠΑΞΙΜΑΔΙ ΑΣΦΑΛΕΙΑΣ ΓΑΛΒΑΝΙΖΕ DIN 985

05648	M 6 mm	2500
05649	M 8 mm	1000
05650	M 10 mm	500
06095	M 12 mm	300
07327	M 14 mm	100
07248	M 16 mm	150
07249	M 18 mm	50
07328	M 20 mm	100

	14119		10103
	14679		10104
	10100		10105
	10101		14852
	10102		14877

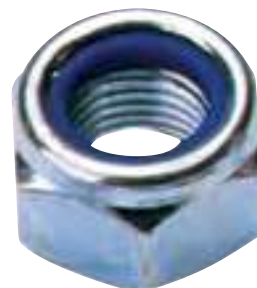

NEW
ARRIVAL

ΠΑΞΙΜΑΔΙ ΑΣΦΑΛΕΙΑΣ ΙΝΟΧ DIN 985

14119	M 4 mm	1000
14679	M 5 mm	1000
10100	M 6 mm	1000
10101	M 8 mm	500
10102	M 10 mm	200
10103	M 12 mm	200
10104	M 14 mm	100
10105	M 16 mm	100
14852	M 18 mm	50
14877	M 20 mm	50

	05467		01203
	02955		01434
	02954		05786
	02956		07064

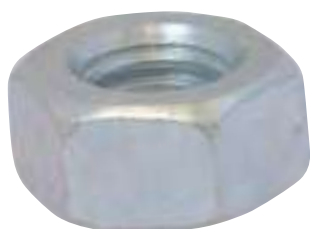

ΠΑΞΙΜΑΔΙ ΙΝΟΧ ΜΕΤΡΙΚΟ DIN 934

05467	M 3 mm	2000
02955	M 4 mm	1000
02954	M 5 mm	1000
02956	M 6 mm	1000
01203	M 8 mm	500
01434	M 10 mm	200
05786	M 12 mm	250
07064	M 14 mm	100

	11335		11337
	11336		11338



ΜΟΥΦΑ ΝΤΙΖΩΝ ΓΑΛΒΑΝΙΖΕ

11335	(M x μήκος) 6x20 mm	300
11336	(M x μήκος) 8x40 mm	100
11337	(M x μήκος) 10x40 mm	50
11338	(M x μήκος) 12x40 mm	50



ΠΕΤΑΛΟΥΔΑ ΜΑΣΙΦ ΓΑΛΒΑΝΙΖΕ DIN 315

Barcode	Size	Quantity
05267	M 6 mm	1000
05588	M 8 mm	800
06026	M 10 mm	500
06027	M 12 mm	200



ΠΕΤΑΛΟΥΔΑ ΜΑΣΙΦ ΓΑΛΒΑΝΙΖΕ ΙΝΤΣΑΣ

Barcode	Size	Quantity
07000	M ¼"	γρόσια
03598	M 5/16"	γρόσια



ΠΕΤΑΛΟΥΔΑ ΜΑΣΙΦ ΙΝΟΧ DIN 315

Barcode	Size	Quantity
11381	M 3 mm	500
11382	M 4 mm	100
11384	M 6 mm	100
11385	M 8 mm	100
11386	M 10 mm	100
11387	M 12 mm	50



ΜΑΠΑ ΘΗΛΥΚΗ ΙΝΟΧ

Barcode	Size	Quantity
12638	M 6 mm	50
12639	M 8 mm	25
12640	M 10 mm	25
12641	M 12 mm	25

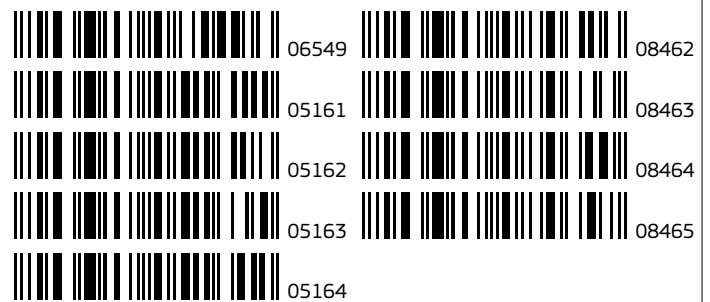

ΓΚΡΟΒΕΡ ΓΑΛΒΑΝΙΖΕ DIN 127

Barcode	Size	Quantity
06549	M 5 mm	1000
05161	M 6 mm	5000
05162	M 8 mm	2800
05163	M 10 mm	1800
05164	M 12 mm	1250
08462	M 14 mm	880
08463	M 16 mm	200
08464	M 18 mm	200
08465	M 20 mm	150



ΓΚΡΟΒΕΡ INOX DIN 127

Barcode	Icon	Box
11388	M 3 mm	1000
11389	M 4 mm	1000
11390	M 5 mm	1000
11391	M 6 mm	1000
11392	M 8 mm	1000
11393	M 10 mm	500
11394	M 12 mm	500
11395	M 14 mm	500



ΡΟΔΕΛΑ INOX DIN 9021

Barcode	Icon	Box
09464	M 4 mm	1000
09465	M 5 mm	1000
09466	M 6 mm	1000
08282	M 8 mm	500
08283	M 10 mm	200
08284	M 12 mm	200
08285	M 14 mm	100
14845	M 18 mm	50



ΡΟΔΕΛΑ DIN 9021

Barcode	Icon	Box
14800	M 5 mm	3000
14801	M 6 mm	1800
14797	M 8 mm	500
14799	M 10 mm	300
14798	M 12 mm	120
00652	M 14 mm	100
15643	M 16 mm	100
14802	M 18 mm	50
15644	M 20 mm	60
10303	M 24 mm	25
09172	M 27 mm	25
09173	M 30 mm	10
10304	M 33 mm	5

GET IT NOW

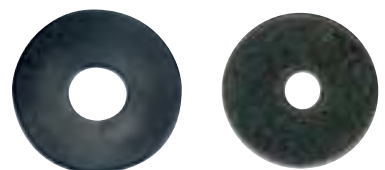

ΡΟΔΕΛΑ ΠΛΑΣΤΙΚΗ

Barcode	Icon	Box
04176	¼" φαρδιά (Kg)	2kg
04983	5/16" φαρδιά (Kg)	2kg
04989	6 mm στενή μαύρη (Kg)	2kg
14573	6,5 mm στενή άσπρη (τμχ.)	8000



ΡΟΔΕΛΑ ΓΑΛΒΑΝΙΖΕ EXTRA LARGE

Barcode	Icon	Quantity
09409	M 5 mm	850
09410	M 6 mm	700
09411	M 8 mm	300
09412	M 10 mm	200
09413	M 12 mm	70
09414	M 14 mm	50
09415	M 16 mm	50

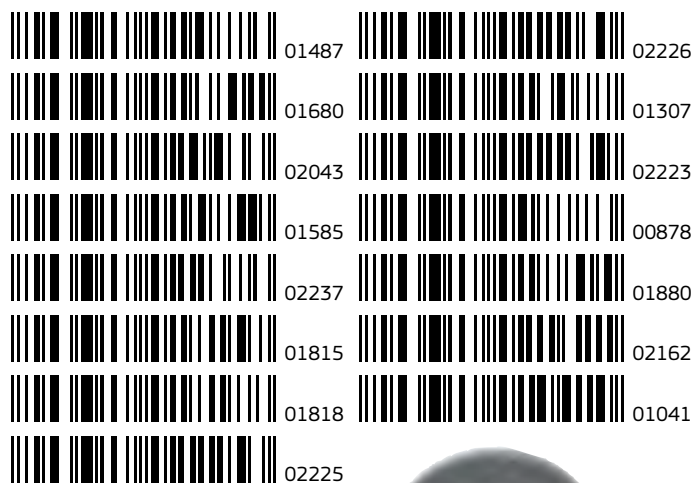

ΡΟΔΕΛΑ ΓΑΛΒΑΝΙΖΕ DIN 125

Barcode	Icon	Quantity
01487	M 5 mm	1000
01680	M 6 mm	5000
02043	M 8 mm	2500
01585	M 10 mm	1500
02237	M 12 mm	500
01815	M 14 mm	700
01818	M 16 mm	450
02225	M 18 mm	200
02226	M 20 mm	300
01307	M 22 mm	200
02223	M 24 mm	150
00878	M 27 mm	50
01880	M 30 mm	50
02162	M 33 mm	50
01041	M 36 mm	50



ΡΟΔΕΛΑ ΓΑΛΒΑΝΙΖΕ ΚΙΛΟΥ

Barcode	Icon	Quantity
01196	M 1/8" (Φ 3 mm)	2kg
03941	M 5/32" (Φ 4 mm)	2kg
03942	M 3/16" (Φ 5 mm)	2kg
03943	M 1/4" (Φ 6 mm)	2kg
03944	M 5/16" (Φ 8 mm)	2kg
03945	M 3/8" (Φ 10 mm)	2kg



ΡΟΔΕΛΑ INOX DIN 125

Barcode	Icon	Quantity
13942	M 3 mm	1000
02950	M 4 mm	1000
02951	M 5 mm	1000
02952	M 6 mm	1000
02953	M 8 mm	1000
01790	M 10 mm	500
06112	M 12 mm	200



ΡΟΔΕΛΑ ΓΑΛΒΑΝΙΖΕ ΠΡΟΚΑΣ

07603	Ø 4/19"	5kg



ΡΟΔΕΛΑ ΜΕΝΤΕΣΕΔΩΝ ΟΡΕΙΧΑΛΚΙΝΗ

08386	M 8 mm	100
05539	M 9 mm	100
06292	M 10 mm	100



ΤΑΠΑ ΒΙΔΑΣ ΚΟΥΜΠΩΤΗ

13053	καφέ	500
13044	λευκή	500

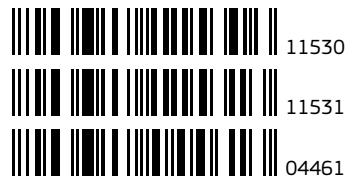

ΝΤΙΖΑ ΚΕΡΑΙΩΝ 5/16

11530	συνολικό μήκος 23 mm	25
11531	συνολικό μήκος 26 mm	25
04461	συνολικό μήκος 33 mm	25



ΝΤΙΖΑ ΚΕΡΑΙΩΝ ΤΟΙΧΟΥ



06065



No 3



25



05303



05319



05316



05461



05317



05377



05318



05644



ΣΤΥΛΩΜΑ ΠΑΡΑΘΥΡΩΝ

05303	19x60	100
05316	20x80	100
05317	20x100	100
05318	20x120	100
05319	21x140	100
05461	22x110	100
05377	22x130	100
05644	22x200	50



ΑΕΡΟΣΤΥΛΩΜΑ ΑΥΤΟΜΑΤΟ



13049



μαύρο



10



02901



00141



00582



05423



02353



02549



ΜΥΛΑΡΑΚΙ ΝΤΟΥΛΑΠΙΩΝ

02901	18x25	200
00582	19x30	200
02353	19x35	200
00141	20x40	200
05423	21x45	200
02549	21x50	200

	03673		00097
	03674		00098
	04975		00099
	06020		00100
	04163		00101
	00110		00102
	00111		00103

THARROS

GET IT NOW



ΑΤΣΑΛΟΚΑΡΦΟ ΙΣΙΟ (100άδα)

03673	(Φ x μήκος) 2,0x20 mm	5
03674	(Φ x μήκος) 2,0x25 mm	5
04975	(Φ x μήκος) 2,0x30mm	5
06020	(Φ x μήκος) 2,0x35 mm	5
04163	(Φ x μήκος) 2,0x40 mm	4
00110	(Φ x μήκος) 3,0x30 mm	10
00111	(Φ x μήκος) 3,0x40 mm	10
00097	(Φ x μήκος) 3,5x40 mm	10
00098	(Φ x μήκος) 3,5x50 mm	10
00099	(Φ x μήκος) 3,5x60 mm	10
00100	(Φ x μήκος) 3,5x70 mm	10
00101	(Φ x μήκος) 3,5x80 mm	10
00102	(Φ x μήκος) 4,0x90 mm	5
00103	(Φ x μήκος) 4,0x100 mm	5

	00105		02876
	00106		00109
	00107		

Martin



GET IT NOW

ΑΤΣΑΛΟΚΑΡΦΟ ΙΣΙΟ (100άδα)

00105	(Φ x μήκος) 2,0x20 mm	12
00106	(Φ x μήκος) 2,0x25 mm	12
00107	(Φ x μήκος) 2,0x30 mm	12
02876	(Φ x μήκος) 2,0x35 mm	10
00109	(Φ x μήκος) 2,0x40 mm	12

	00112
	00113
	00114

THARROS



ΑΤΣΑΛΟΚΑΡΦΟ L ΡΙΓΩΤΟ (100άδα)

00112	(Φ x μήκος) 4,0x40 mm	5
00113	(Φ x μήκος) 4,0x50 mm	5
00114	(Φ x μήκος) 4,0x60 mm	5



ΑΤΣΑΛΟΚΑΡΦΟ L ΙΣΙΟ (100άδα)

10984	(Φ x μήκος) 3,6x60 mm	1



Martin

GET IT NOW

ΑΤΣΑΛΟΚΑΡΦΟ ΡΙΓΩΤΟ (100άδα)

Barcode	Icon	Box
01042	(Φ x μήκος) 3,5x50 mm	10
03376	(Φ x μήκος) 3,5x60 mm	10
01484	(Φ x μήκος) 3,5x70 mm	10
00842	(Φ x μήκος) 3,5x80 mm	10
10981	(Φ x μήκος) 4,0x120 mm	5



GET IT NOW

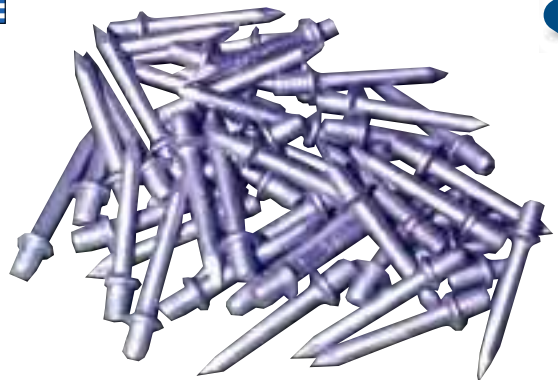

ΑΤΣΑΛΟΚΑΡΦΟ ΜΕ ΒΟΛΤΑ «ΡΟΜΠΟΤ» Μ6 (100άδα)

Barcode	Icon	Box
02992	(Φ x μήκος) 8x18 mm	10
02308	(Φ x μήκος) 8x25 mm	10
02392	(Φ x μήκος) 8x30 mm	10
04575	(Φ x μήκος) 8x35 mm	10



ΑΤΣΑΛΟΚΑΡΦΟ ΡΙΓΩΤΟ ΤΑΪΒΑΝ (100άδα)

Barcode	Icon	Box
02766	(Φ x μήκος) 3,5x50 mm	10
02767	(Φ x μήκος) 3,5x60 mm	10
02784	(Φ x μήκος) 3,5x70 mm	10
02788	(Φ x μήκος) 3,5x80 mm	10

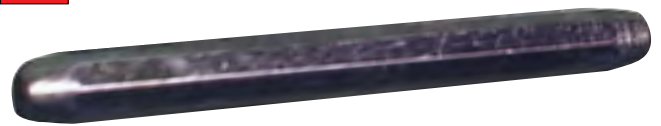

ΖΟΥΜΠΙΑΣ ΑΤΣΑΛΟΚΑΡΦΩΝ ΡΟΜΠΟΤ

Barcode	Icon	Box
02170		6

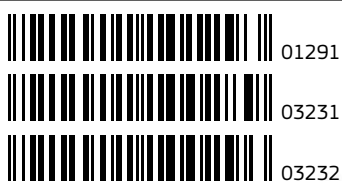

HOT SELLER

THARROS



ΑΤΣΑΛΟΚΑΡΦΟ ΡΙΓΩΤΟ (100άδα)

Barcode	Icon	Box
01291	(Φ x μήκος) 3,5x50 mm	5
03231	(Φ x μήκος) 3,5x60 mm	5
03232	(Φ x μήκος) 3,5x70 mm	5

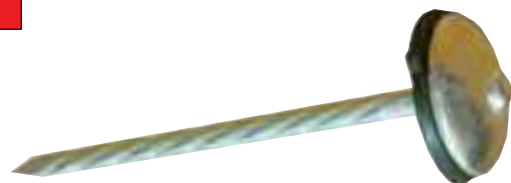

ΚΑΡΦΙ ΜΕ ΡΟΔΕΛΛΑ

Barcode	Icon	Box
12021	(Φ x μήκος) 3,7x50 mm	10kg
07894	(Φ x μήκος) 3,7x70 mm	10kg
09416	(Φ x μήκος) 3,7x70 mm - κόκκινο κεφάλι	10kg
08936	(Φ x μήκος) 3,7x90 mm - κόκκινο κεφάλι	10kg



ΛΑΣΤΙΧΑΚΙΑ ΓΙΑ ΚΑΡΦΙΑ



00642

Φ εσωτερικό 3mm

2kg



ΚΑΡΦΩΤΙΚΟ ΜΕΓΑΛΟ ΤΑΪΒΑΝ



00623

4-14 mm

2



01773



01213



01214



00614



00622



ΚΑΡΦΙΑ ΔΙΧΑΛΑ ΧΕΙΡΟΣ (ΠΑΚΟ 5000 τμχ.)



01773

530/6

5

01213

530/8

5

01214

530/10

5

00614

530/12

5

00622

530/14

5



00596



02411



00219



00479



02412



00616



ΚΑΡΦΙΑ ΔΙΧΑΛΑ ΑΕΡΟΣ (ΠΑΚΟ 10000 τμχ.)



00596

80/6

5

00219

80/8

4

02412

80/10

4

02411

80/12

4

00479

80/14

5

00616

80/16

5



01115



03998



03997



03996



ΠΡΟΚΑ ΣΙΤΑΣ



01115

1/2

4

03998

5/8

4

03997

3/4

4

03996

1

4



ΤΕΛΑΚΙ ΔΙΧΑΛΟ

10389	11x16	5kg
04814	13x20	5kg
01802	14x25	5kg
04579	15x35	5kg



ΤΕΛΑΚΙ ΠΛΑΤΥΚΕΦΑΛΟ

02410	7/16	5kg
04815	7/20	5kg
01866	8/20	5kg
03760	9/25	5kg
01563	10/30	5kg
03761	11/35	5kg
01044	12/40	5kg
03762	12/45	5kg
03763	12/50	5kg
05637	14/60	5kg



ΤΕΛΑΚΙ ΑΚΕΦΑΛΟ

01917	6/16	5kg
01565	6/22	5kg
02428	7/20	5kg
02244	9/25	5kg
01564	10/30	5kg
03756	11/35	5kg
03757	12/40	5kg
03758	12/45	5kg
03759	12/50	5kg

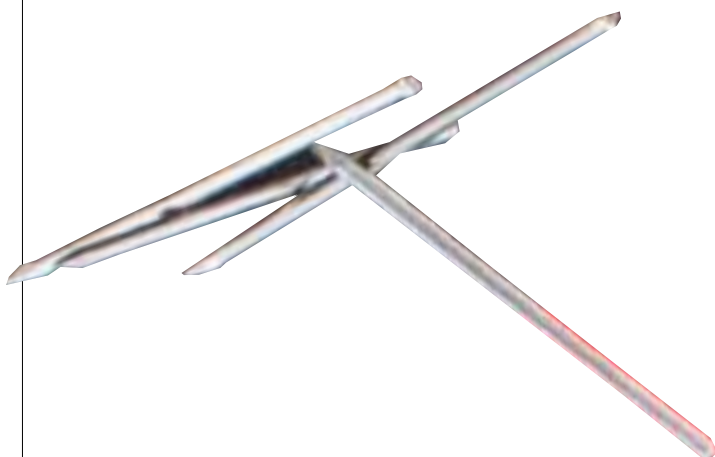

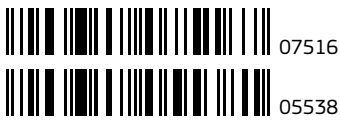

ΤΕΛΑΚΙΑ ΠΙΣΟΧΑΡΤΟΥ

Barcode	Icon	Weight
07516	17/20	5kg
05538	17/30	5kg

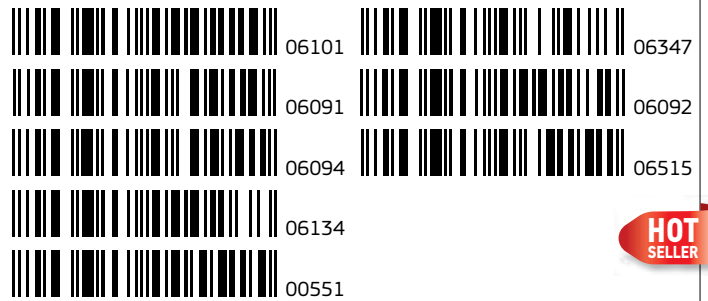

**HOT
SELLER**

ΚΑΡΦΟΒΕΛΟΝΑ ΚΟΙΝΗ

Barcode	Icon	Weight
06101	15x15 (2,4x38 mm)	10kg
06091	16x21 (2,7x53 mm)	10kg
06094	16x24 (2,7x60 mm)	10kg
06134	17x27 (3,0x68 mm)	10kg
00551	18x33 (3,4x83 mm)	10kg
06347	18x36 (3,4x90 mm)	10kg
06092	19x45 (4,0x113 mm)	10kg
06515	23x70 (6,0x175 mm)	5kg

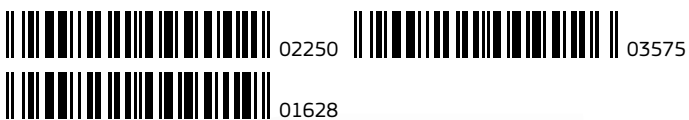

ΚΑΡΦΑΚΙΑ ΚΑΔΡΩΝ ΙΝΚΣ

Barcode	Icon	Weight
02250	No 0	25
01628	No 1	25
03575	No 2	25



ΚΑΡΦΟΒΕΛΟΝΑ ΓΑΛΒΑΝΙΖΕ

Barcode	Icon	Weight
06791	15x15 (2,4x38 mm)	5kg
00025	16x21 (2,7x53 mm)	5kg
05881	16x24 (2,7x60 mm)	5kg
06763	17x27 (3,0x68 mm)	5kg
07154	18x33 (3,4x83 mm)	5kg
02030	18x36 (3,4x90 mm)	5kg
06655	19x45 (4,0x113 mm)	5kg

	02111		00620
	01178		01186
	01179		03781
	00519		03782
	00542		01894
	08225		10589
	01180		01188
	01181		02562
	01182		01189
	01183		01190
	01184		06565
	01185		



ΠΡΙΤΣΙΝΙΑ ΑΛΟΥΜΙΝΙΟΥ

02111	(Φ x μήκος) 3,2x8 mm	1000
01178	(Φ x μήκος) 3,2x10 mm	1000
01179	(Φ x μήκος) 3,2x12 mm	1000
00519	(Φ x μήκος) 3,2x14 mm	1000
00542	(Φ x μήκος) 3,2x16 mm	1000
08225	(Φ x μήκος) 4,0x8 mm	1000
01180	(Φ x μήκος) 4,0x9 mm	1000
01181	(Φ x μήκος) 4,0x10 mm	1000
01182	(Φ x μήκος) 4,0x12 mm	1000
01183	(Φ x μήκος) 4,0x14 mm	1000
01184	(Φ x μήκος) 4,0x16 mm	500
01185	(Φ x μήκος) 4,0x19 mm	500
00620	(Φ x μήκος) 4,0x22 mm	500
01186	(Φ x μήκος) 4,0x25 mm	500
03781	(Φ x μήκος) 4,8x8 mm	1000
03782	(Φ x μήκος) 4,8x10 mm	500
01894	(Φ x μήκος) 4,8x12 mm	500
10589	(Φ x μήκος) 4,8x14 mm	500
01188	(Φ x μήκος) 4,8x16 mm	500
02562	(Φ x μήκος) 4,8x19 mm	500
01189	(Φ x μήκος) 4,8x22 mm	250
01190	(Φ x μήκος) 4,8x25 mm	1000
06565	(Φ x μήκος) 4,8x30 mm	250

	03271
	03190
	03272



ΠΡΙΤΣΙΝΙΑ ΑΛΟΥΜΙΝΙΟΥ ΛΕΥΚΑ

03271	(Φ x μήκος) 4,0x10 mm	1000
03190	(Φ x μήκος) 4,0x12 mm	1000
03272	(Φ x μήκος) 4,0x14 mm	1000

	00775
	01774



ΠΙΝΕΖΕΣ (ΠΑΚΟ 100 τμχ.)

00775	κίτρινες	25
01774	χρωματιστές	25



Morgan.

• Γενικής Χρήσης



ΠΙΝΕΛΟ HOBBY ΠΛΑΣΤΙΚΗ ΛΑΒΗ

Barcode	Icon	Icon
05219	1" - 25mm	12
05220	1½" - 38mm	12
05221	2" - 50mm	12
05222	2½" - 63mm	12
05223	3" - 76mm	12



• Γενικής Χρήσης



ΠΙΝΕΛΟ ΔΙΠΛΟ ΠΛΑΣΤΙΚΗ ΛΑΒΗ

Barcode	Icon	Icon
13772	1" - 25mm	12
13773	1½" - 40mm	12
13774	2" - 50mm	12
13775	2½" - 60mm	12
13776	3" - 70mm	12



Morgan.

• Γενικής Χρήσης



ΠΙΝΕΛΟ PRESTIGE ΞΥΛΙΝΗ ΛΑΒΗ

Barcode	Icon	Icon
05224	1" - 25cm	12
05225	1½" - 38	12
05226	2" - 50	12
05227	2½" - 63mm	12
05228	3" - 76mm	12



• Γενικής Χρήσης



ΠΙΝΕΛΟ ΥΠΕΡΔΙΠΛΟ AMERICANA ΞΥΛΙΝΗ ΛΑΒΗ

Barcode	Icon	Icon
13110	1" - 25mm	12
13111	1½" - 40mm	12
13112	2" - 50mm	12
13113	2½" - 60mm	12
13114	3" - 70mm	12



• Γενικής Χρήσης



ΠΙΝΕΛΟ ΔΙΠΛΟ ΕΥΡΟΤΟΡ Α ΠΛΑΣΤΙΚΗ ΛΑΒΗ

Barcode	Icon	Box
13115	20mm	12
13116	30mm	12
13117	40mm	12
13118	50mm	12
13119	60mm	12
13120	70mm	12



• Γενικής Χρήσης



ΠΙΝΕΛΟ ΗΜΙΔΙΠΛΟ 332 ΠΛΑΣΤΙΚΗ ΛΑΒΗ

Barcode	Icon	Box
08161	30mm	12
08162	40mm	12
08163	50mm	12
08164	60mm	12



• Υδατοδιαλυτά χρώματα



ΠΙΝΕΛΟ ΔΙΠΛΟ ΣΥΝΘΕΤΙΚΟ ΞΥΛΙΝΗ ΛΑΒΗ

Barcode	Icon	Box
13291	1" - 25mm	12
13292	1½" - 40mm	12
13293	2" - 50mm	12
13294	2½" - 60mm	12
13295	3" - 70mm	12



• Γενικής Χρήσης



ΠΙΝΕΛΟ ΗΜΙΔΙΠΛΟ ΠΛΑΣΤΙΚΗ ΛΑΒΗ

Barcode	Icon	Box
13285	20mm	24
13286	30mm	24
13287	40mm	24
13288	50mm	24
13289	60mm	24
13290	70mm	24



13767



13768



13769



13770



13771



• Γενικής Χρήσης



ΠΙΝΕΛΟ ΜΟΝΟ ΞΥΛΙΝΗ ΛΑΒΗ

13767	1" - 25mm	24
13768	1½" - 40mm	24
13769	2" - 50mm	24
13770	2½" - 60mm	24
13771	3" - 70mm	24



13121



13122



13123



13124



13125



• Γενικής Χρήσης



ΠΙΝΕΛΟ ΗΜΙΔΙΠΛΟ ΞΥΛΙΝΗ ΛΑΒΗ

13121	20mm	12
13122	30mm	12
13123	40mm	12
13124	50mm	12
13125	60mm	12
13126	70mm	12



08166



08167

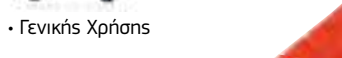

08168



08169



08170



• Γενικής Χρήσης



ΠΙΝΕΛΟ ΜΟΝΟ 330 ΠΛΑΣΤΙΚΗ ΛΑΒΗ

08166	30mm	12
08167	40mm	12
08168	50mm	12
08169	60mm	12
08170	70mm	12



13761



13762

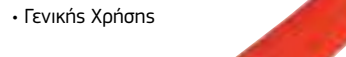

13763



13764



13765



13766



• Γενικής Χρήσης



ΠΙΝΕΛΟ ΗΜΙΔΙΠΛΟ ECONOMY ΠΛΑΣΤΙΚΗ ΛΑΒΗ

13761	20mm	24
13762	30mm	24
13763	40mm	24
13764	50mm	24
13765	60mm	24
13766	70mm	24



• Υδατοδιαλυτά χρώματα



ΠΙΝΕΛΟ ΣΥΝΘΕΤΙΚΟ SILC ΞΥΛΙΝΗ ΛΑΒΗ

Barcode	Icon	Code	Quantity
13456		1" - 25mm	12
13457		1½" - 40mm	12
13458		2" - 50mm	12
13459		2½" - 60mm	12
13460		3" - 70mm	12

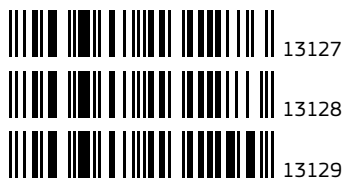

• Γενικής Χρήσης



ΚΟΝΤΑΡΟΠΙΝΕΛΟ ΠΛΑΣΤΙΚΗ ΛΑΒΗ

Barcode	Icon	Code	Quantity
13127		2" - 50mm	12
13128		2½" - 60mm	12
13129		3" - 70mm	12



ΠΙΝΕΛΟ ΖΩΓΡΑΦΙΚΗΣ 22924 ΠΛΑΚΕ ΜΑΥΡΗ ΤΡΙΧΑ

Barcode	Icon	Code	Quantity
13255		No. 12	12
13256		No. 14	12
13257		No. 16	12
13258		No. 18	12
13259		No. 20	12

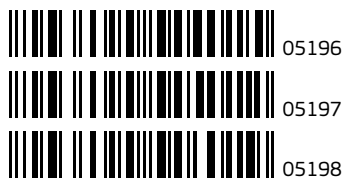

Morgan.

• Γενικής Χρήσης



ΣΤΡΑΒΟΠΙΝΕΛΟ ΠΛΑΣΤΙΚΗ ΛΑΒΗ

Barcode	Icon	Code	Quantity
05196		40mm - code: 5440	12
05197		50mm - code: 5450	12
05198		60mm - code: 5460	12



ΣΤΡΑΒΟΠΙΝΕΛΑ - ΠΑΤΡΟΓΚΕΣ



13132

13135



13133

13136



13134

13137



• Γενικής Χρήσης



ΣΤΡΑΒΟΠΙΝΕΛΟ ΞΥΛΙΝΗ ΛΑΒΗ

Barcode	Icon	Quantity
13132	20cm	6
13133	1" - 25mm	6
13134	1½" - 40mm	6
13135	2" - 50mm	6
13136	2½" - 60mm	6
13137	3" - 70mm	6

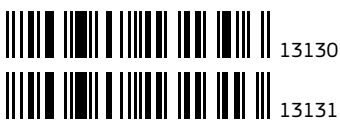

13130



13131



• Γενικής Χρήσης



ΣΤΡΑΒΟΠΙΝΕΛΟ ΚΟΝΤΟ ΞΥΛΙΝΗ ΛΑΒΗ

Barcode	Icon	Quantity
13130	1½" - 40mm	12
13131	2" - 50mm	12



Morgan.

• Γενικής Χρήσης



ΠΑΤΡΟΓΚΑ ΠΛΑΣΤΙΚΗ 4312

Barcode	Icon	Quantity
05594	120x30mm (μήκος x πλάτος)	6



• Γενικής Χρήσης

GET IT NOW



ΠΑΤΡΟΓΚΑ ΞΥΛΙΝΗ ΜΕ ΤΣΕΡΚΙ

Barcode	Icon	Quantity
13819	150x50mm (μήκος x πλάτος)	6



• Γενικής Χρήσης



ΠΑΤΡΟΓΚΑ ΞΥΛΙΝΗ Νο 60

Barcode	Icon	Quantity
05896	150x60mm (μήκος x πλάτος)	24



ΜΠΑΤΑΝΟΒΟΥΡΤΣΑ

Code	Dimensions	Quantity
07884	Φ 24cm	6
07885	Φ 26cm	6
07886	Φ 28cm	6
07887	Φ 30cm	6
07888	Φ 32cm	6



ΠΕΝΤΑΦΘΑΛΜΟ

Code	Quantity
07889	12

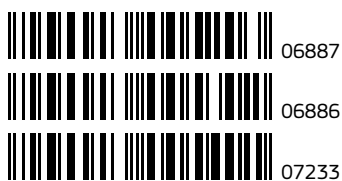

ΜΠΑΤΑΝΟΒΟΥΡΤΣΑ ΜΥΛΤΙ ΣΤΡΟΓΓΥΛΗ

Code	Dimensions	Quantity
06887	Φ 9,5cm - code: 520	6
06886	Φ 11,5cm - code: 530	6
07233	Φ 12,5cm - code: 540	6



ΧΕΙΡΟΒΟΥΡΤΣΑ ΣΤΡΟΓΓΥΛΗ

Code	Quantity
07892	12



**HOT
SELLER**

ΜΠΑΤΑΝΟΒΟΥΡΤΣΑ ΜΥΛΤΙ

Code	Dimensions	Quantity
06889	150x55mm - code: 440	12
06888	230x70mm - code: 400	6



ΚΑΡΑΒΑΚΙ ΠΛΑΣΤΙΚΟ (ΑΠΟΜΙΜΗΣΗ ΞΥΛΟΥ)

Code	Dimensions	Quantity
04347	200x25mm (μήκος x πλάτος)	28

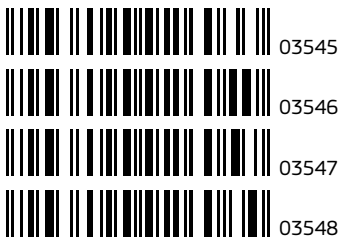

Morgan.



ΚΟΝΤΑΡΙ ΠΤΥΣΣΟΜΕΝΟ ΑΛΟΥΜΙΝΙΟΥ

03545	μήκος 3m	6
03546	μήκος 4m	4
03547	μήκος 5m	4
03548	μήκος 6m	4

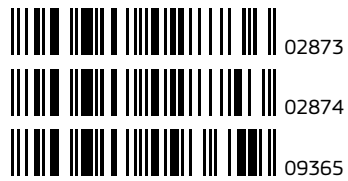

ΚΟΝΤΑΡΙ ΠΤΥΣΣΟΜΕΝΟ ΜΕΤΑΛΛΙΚΟ

02873	μήκος 2m	10
02874	μήκος 3m	10
09365	ανταλλακτικοί κώνοι	10

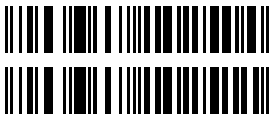

10250



10251

INTER



ΠΙΣΤΟΛΙ ΒΑΦΗΣ ΚΑΤΩ ΔΟΧΕΙΟ 1000 ml

10250	μπεκ 1,7mm	2
10251	μπεκ 2,0mm	2

GET IT NOW



INTER



ΠΙΣΤΟΛΙ ΒΑΦΗΣ ΑΕΡΟΓΡΑΦΟΣ 125 ml

13722	μπεκ 0,8mm	1

GET IT NOW



INTER



ΠΙΣΤΟΛΙ ΒΑΦΗΣ G70 ΚΑΤΩ ΔΟΧΕΙΟ 1000 ml

06207	μπεκ 1,8mm	2

GET IT NOW



INTER



ΠΙΣΤΟΛΙ ΒΑΦΗΣ ΑΝΩ ΔΟΧΕΙΟ 600 ml

10252	μπεκ 1,7mm	2

GET IT NOW



05255

05004

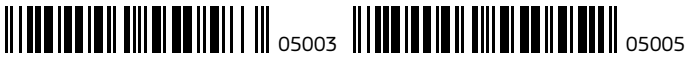

05003

05005



GET IT NOW



•Κατάλληλο για γυαλιστερά και αλκιδικά χρώματα, βερνίκια, μονωτικά, λαδομπογιές σε λείες και μέτριες επιφάνειες.

ΡΟΛΟ ΜΟΧΕΡ 4550

Barcode	Length	Quantity
05255	50mm	20
05003	80mm	10
05004	110mm	10
05005	150mm	10

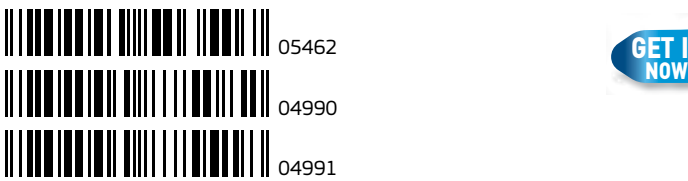

05462

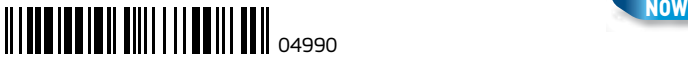

04990

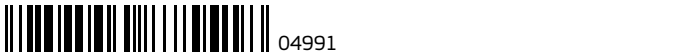

04991



GET IT NOW



•Κατάλληλο για όλους τους τύπους χρωμάτων σε λείες επιφάνειες.

ΡΟΛΟ ΑΦΡΩΔΕΣ ΚΑΘΑΡΕΣ ΑΚΡΕΣ 4875

Barcode	Length	Quantity
05462	50mm	20
04990	70mm	20
04991	110mm	10



•Κατάλληλο για γυαλιστερά και αλκιδικά χρώματα, βερνίκια σε λείες επιφάνειες.

ΡΟΛΟ ΜΑΥΡΟ ΑΦΡΩΔΕΣ 4611

Barcode	Length	Quantity
13220	100mm	10



•Κατάλληλο για γυαλιστερά και αλκιδικά χρώματα, βερνίκια σε λείες επιφάνειες.

ΡΟΛΟ ΑΦΡΩΔΕΣ 4879

Barcode	Length	Quantity
04998	110mm	10



•Κατάλληλο για ακρυλικά χρώματα σε λείες και μέτριες επιφάνειες.

ΡΟΛΟ ΑΚΡΥΛΙΚΗΣ ΒΑΦΗΣ 4925

Barcode	Length	Quantity
05002	110mm	10

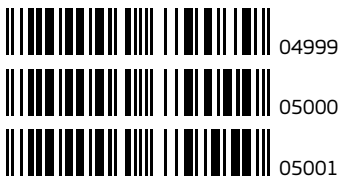

L'OUTIL PARFAIT
fabricant



•Κατάλληλο για γυαλιστερά και ακρυλικά χρώματα σε λείες επιφάνειες.

ΡΟΛΟ ΒΕΛΟΥΤΕ 4679

Barcode	Icon	Box
04999	70mm	20
05000	110mm	10
05001	150mm	10



L'OUTIL PARFAIT
fabricant



•Κατάλληλο για όλους τους τύπους χρωμάτων σε λείες και μέτριες επιφάνειες.

ΡΟΛΟ ΠΕΡΛΟΝ (POLYAMIDE) 4989

Barcode	Icon	Box
05006	110mm	10

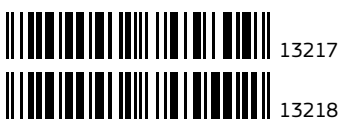

L'OUTIL PARFAIT
fabricant

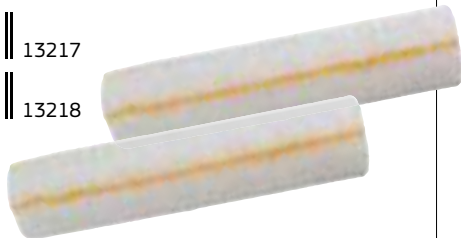

•Κατάλληλο για όλους τους τύπους χρωμάτων σε λείες και μέτριες επιφάνειες.

ΡΟΛΟ ΠΕΡΛΟΝ (POLYAMIDE) 974

Barcode	Icon	Box
13217	180mm	6
13218	250mm	6

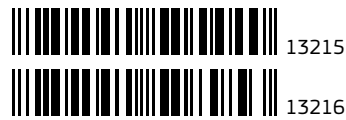

L'OUTIL PARFAIT
fabricant



•Κατάλληλο για υδροχρώματα, ακρυλικά, πλαστικά, βερνίκια, εποξικά, αστάρια, μονωτικά, λάκα σε λείες και μέτριες επιφάνειες.

ΡΟΛΟ MICROFIBER 988

Barcode	Icon	Box
13215	180mm	6
13216	250mm	6



L'OUTIL PARFAIT
fabricant



•Κατάλληλο για υδροχρώματα, ακρυλικά, πλαστικά, βερνίκια, εποξικά, αστάρια, μονωτικά, λάκα σε λείες και μέτριες επιφάνειες.

ΡΟΛΟ MICROFIBER 986 ΜΕ ΛΑΒΗ

Barcode	Icon	Box
13229	180mm	1



L'OUTIL PARFAIT
fabricant



•Κατάλληλο για όλους τους τύπους χρωμάτων σε λείες και μέτριες επιφάνειες.

ΡΟΛΟ MICROLISS 4932

Barcode	Icon	Box
13222	110mm	10



10155

05008



05007

05009

**L'OUTIL
PARFAIT**
fabricsart

**GET IT
NOW**



•Κατάλληλο για όλους τους τύπους χρωμάτων σε λείες και μέτριες επιφάνειες.

ΡΟΛΟ ΚΑΛΟΡΙΦΕΡ 4991

Barcode	Icon	Quantity
10155		50mm 20
05007		80mm 10
05008		110mm 10
05009		150mm 10



Morgan.

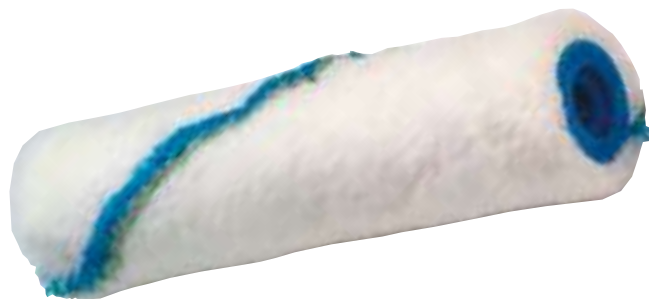

•Κατάλληλο για ακρυλικά χρώματα σε λείες και μέτριες επιφάνειες.

ΡΟΛΟ ΑΚΡΥΛΙΚΟ ΓΙΑ ΛΑΒΗ ΧΩΡΙΣ ΒΙΔΑ

Barcode	Icon	Quantity
05204		240mm - code: 4429 6



INTER

BLISTER



•Κατάλληλο για υδροχρώματα, ακρυλικά, πλαστικά, βερνίκια, εποξικά, αστάρια, μονωτικά, λάκα σε λείες και μέτριες επιφάνειες.

ΡΟΛΟ MICROFIBER

Barcode	Icon	Quantity
13063		60mm 10



13076



13077



•Κατάλληλο για ακρυλικά, πλαστικά, εποξικά, και μονωτικά πίσσας σε λείες και μέτριες επιφάνειες.

ΡΟΛΟ ΠΟΛΥΕΣΤΕΡΙΚΟ ΜΕ ΛΑΒΗ

Barcode	Icon	Quantity
13076		180mm 5
13077		250mm 5

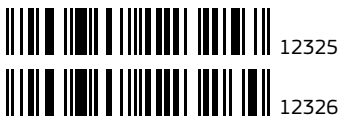

GET IT NOW



•Κατάλληλο για υδροχρώματα, πλαστικά και ακρυλικά σε λείες και μέτριες επιφάνειες.

ΡΟΛΟ ΓΟΥΝΑΣ ΚΟΥΡΕΜΕΝΟ EXTRA FINE ΜΕ ΛΑΒΗ EASY PAINT

Barcode	Icon	Icon
12325	180mm	12
12326	240mm	12

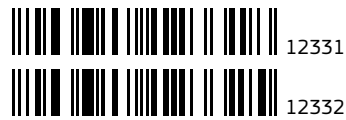

GET IT NOW



•Κατάλληλο για υδροχρώματα, πλαστικά και ακρυλικά σε λείες και μέτριες επιφάνειες.

ΡΟΛΟ ΓΟΥΝΑΣ ΚΟΥΡΕΜΕΝΟ EXTRA FINE ΜΕ ΛΑΒΗ EASY PAINT

Barcode	Icon	Icon
12331	180mm	12
12332	240mm	12

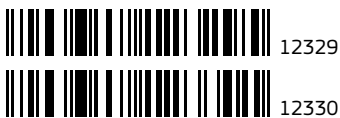

GET IT NOW



•Κατάλληλο για υδροχρώματα, πλαστικά και ακρυλικά σε μέτριες και ανάγλυφες επιφάνειες.

ΡΟΛΟ ΓΟΥΝΑΣ ΑΚΟΥΡΕΥΤΟ EXTRA FINE ΜΕ ΛΑΒΗ EASY PAINT

Barcode	Icon	Icon
12329	180mm	12
12330	240mm	12

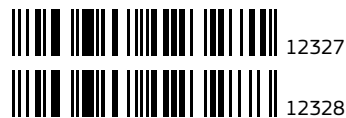

GET IT NOW



•Κατάλληλο για υδροχρώματα, πλαστικά και ακρυλικά σε σπατουλαριστές και λείες επιφάνειες.

ΡΟΛΟ ΓΟΥΝΑΣ ΣΠΑΤΟΥΛΑΡΙΣΤΟ EXTRA FINE ΜΕ ΛΑΒΗ EASY PAINT

Barcode	Icon	Icon
12327	180mm	12
12328	240mm	12

Morgan.



ΛΑΒΗ ΧΩΡΙΣ ΒΙΔΑ ΓΙΑ ΑΚΡΥΛΙΚΟ ΡΟΛΟ

05205	7" - 4437	12
-------	-----------	----

08171
14081



**ΛΑΒΗ ΡΟΛΟΥ
EASY PAINT**

08171	7"	12
14081	9"	12

L'OUTIL PARFAIT[®]
fabricant

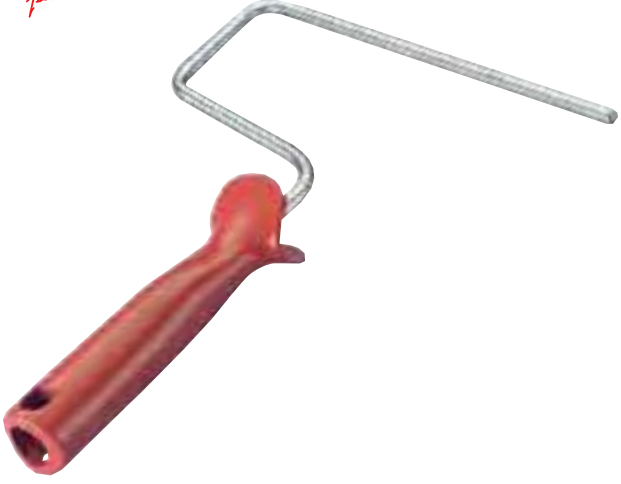

ΛΑΒΗ ΡΟΛΟΥ 1993

08937	180mm	6
-------	-------	---

06136
05254
05010

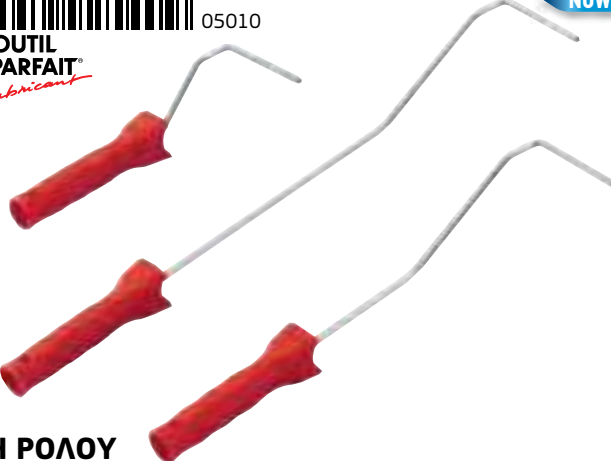

L'OUTIL PARFAIT[®]
fabricant

ΛΑΒΗ ΡΟΛΟΥ

06136	992 / 19cm	6
05254	9925 / 29cm	6
05010	9925 / 40cm	6

HOT SELLER
GET IT NOW

HOT SELLER



ΣΚΑΦΑΚΙ ΧΡΩΜΑΤΩΝ ΜΙΚΡΟ

06265	29x15,5cm	10
-------	-----------	----

GET IT NOW



ΣΚΑΦΑΚΙ ΧΡΩΜΑΤΩΝ ΜΕΣΑΙΟ

06454	31,5x23,5cm	10
-------	-------------	----



**HOT
SELLER**

ΣΚΑΦΑΚΙ ΧΡΩΜΑΤΩΝ ΜΕΓΑΛΟ

05209	36,5x29,5cm	10



**NEW
ARRIVAL**

ΚΟΥΒΑΣ ΧΡΩΜΑΤΟΣ 13 lt

14437		25



05591



05590

Morgan.



05591

05590

ΑΝΑΔΕΥΤΗΡΑΣ ΚΟΛΛΑΣ 600X120 mm

05591	έλικας 6220	5
05590	τετράγ. 6120	5



BELLOTA



ΑΝΑΔΕΥΤΗΡΑΣ ΚΟΛΛΑΣ 50787-120

05713	590x120 mm (μήκος x Φ)	2



ΑΝΑΔΕΥΤΗΡΑΣ ΚΟΛΛΑΣ ΑΧΛΑΔΙ



03181

580x100 mm (μήκος x Φ)

5



ΑΝΑΔΕΥΤΗΡΑΣ ΚΟΛΛΑΣ ΤΕΤΡΑΓΩΝΟΣ



04162

600x120x mm (μήκος x Φ)

5



02852



05589



00146

Morgan.



ΑΝΑΔΕΥΤΗΡΑΣ ΧΡΩΜΑΤΩΝ



02852

400x60 mm (μήκος x Φ) - code: 6060

6

05589

400x80 mm (μήκος x Φ) - code: 6080

6

00146

600x100 mm (μήκος x Φ) - code: 6010

6



03180



02834

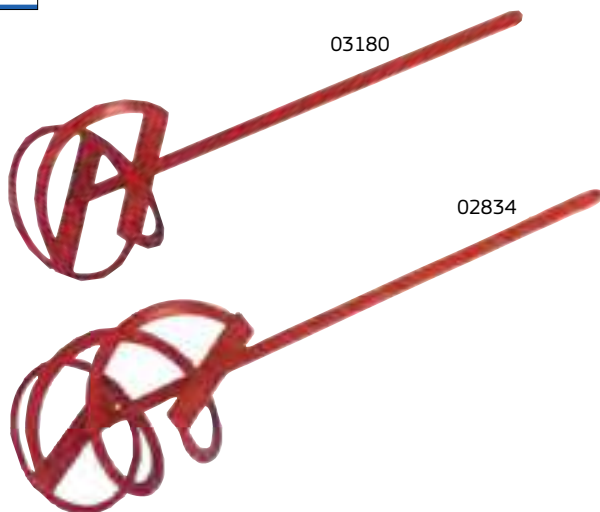

ΑΝΑΔΕΥΤΗΡΑΣ ΚΟΛΛΑΣ ΕΛΙΚΑΣ 600X115 mm



03180

ύψος σπείρας 75 mm (μικρός)

5

02834

ύψος σπείρας 140 mm (μεγάλος)

5

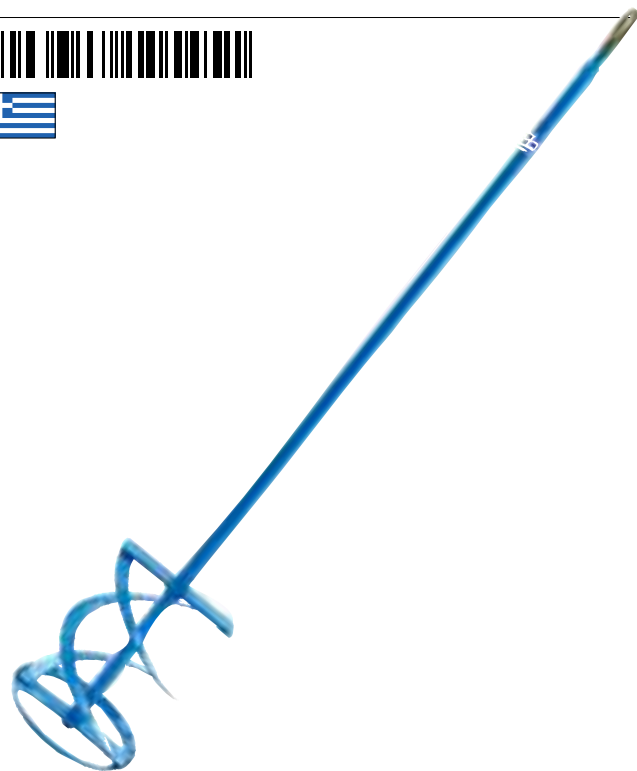

ΑΝΑΔΕΥΤΗΡΑΣ ΧΡΩΜΑΤΩΝ ΕΛΙΚΑΣ ΜΕ ΥΠΟΔΟΧΗ SDS plus



10545

650x110 mm (μήκος x Φ)



1



 **Den Braven**



ΠΙΣΤΟΛΙ ΣΙΛΙΚΟΝΗΣ ΤΥΠΟΥ ΑΓΓΛΙΑΣ ΗΚΜ



  
09971 310ml 6



 **ALTACHEM**
ALFA GROUP



ΠΙΣΤΟΛΙ ΣΙΛΙΚΟΝΗΣ ΜΕ ΣΤΟΠ ΤΥΠΟΥ ΑΓΓΛΙΑΣ CG-SK 10



  
14136 310ml 6



 **BELLOTA**



ΠΙΣΤΟΛΙ ΣΙΛΙΚΟΝΗΣ ΕΠΑΓΓΕΛΜΑΤΙΚΟ 50264



  
13309 310ml 6



 **BELLOTA**



ΠΙΣΤΟΛΙ ΣΙΛΙΚΟΝΗΣ ΤΥΠΟΥ ΑΓΓΛΙΑΣ



  
07684 50260 12



 **BELLOTA**



ΠΙΣΤΟΛΙ ΣΙΛΙΚΟΝΗΣ 50262

  
07382 310ml 12



ΠΙΣΤΟΛΙΑ ΣΙΛΙΚΟΝΗΣ



ΠΙΣΤΟΛΙ ΣΙΛΙΚΟΝΗΣ ΚΛΕΙΣΤΟΥ ΤΥΠΟΥ ΤΑΪΒΑΝ

05834 600ml 3



ΠΙΣΤΟΛΙ ΓΙΑ ΑΡΜΟΛΟΓΙΣΗ ΤΑΪΒΑΝ

06015 WT-256JPG 6



ΠΙΣΤΟΛΙ ΒΑΡΕΩΣ ΤΥΠΟΥ ΧΡΩΜΕ

01701 310ml 6



ΠΙΣΤΟΛΙ ΣΙΛΙΚΟΝΗΣ ΕΛΑΦΡΟΥ ΤΥΠΟΥ

01121 310ml 6



04877
04878

Λ'OUTIL PARFAIT[®]
fabricant

ΕΥΣΤΡΑ ΤΡΙΓΩΝΙΚΗ 360

04877	πλάτος 60mm	5
04878	πλάτος 80mm	5



Λ'OUTIL PARFAIT[®]
fabricant

ΕΥΣΤΡΑ ΚΟΝΤΗ 518

04864	πλάτος 65mm	6



Λ'OUTIL PARFAIT[®]
fabricant

ΕΥΣΤΡΑ ΕΠΑΓΓΕΛΜΑΤΙΚΗ ΜΑΚΡΥΑ ΛΑΒΗ 365

04865	πλάτος 60mm	10



Λ'OUTIL PARFAIT[®]
fabricant

ΕΥΣΤΡΑ ΙΝΟΧ ΠΟΛΛΑΠΛΩΝ ΧΡΗΣΕΩΝ 507

04860	πλάτος 70mm	6



Λ'OUTIL PARFAIT[®]
fabricant

ΕΥΣΤΡΑ ΚΑΛΕΜΙ 535

04902	πλάτος 65mm	6



04879
13882

Λ'OUTIL PARFAIT[®]
fabricant

ΕΥΣΤΡΑ ΚΟΝΤΑΡΙΟΥ 879

04879	πλάτος 150mm	5
13882	πλάτος 300mm	5

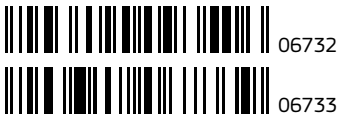

06732

06733

Morgan.



ΞΥΣΤΡΑ ΤΡΙΓΩΝΙΚΗ

06732	πλάτος 60mm - code: 9350	6
06733	πλάτος 80mm - code: 9355	6



ΞΥΣΤΡΑ ΚΟΝΤΑΡΙΟΥ ΧΕΙΡΟΠΟΙΗΤΗ ΔΑΠΕΔΟΥ

02871	(A x B) 315x400mm	5



Morgan.



ΞΥΣΤΡΑ ΚΑΛΕΜΙ ΜΑΚΡΙΑ ΛΑΒΗ 9360

06747	πλάτος 60mm	6



10543



10544



ΞΥΣΤΡΑ ΚΟΝΤΑΡΙΟΥ ΤΟΙΧΟΥ

10543	πλάτος 150mm	5
10544	πλάτος 200mm	5



Morgan.



ΞΥΣΤΡΑ 9310

06730	πλάτος 65mm	12



02449



02870

INTER



ΞΥΣΤΡΑ ΚΟΝΤΑΡΙΟΥ ΤΟΙΧΟΥ

02449	πλάτος 150mm	5
02870	πλάτος 200mm	5



ΞΥΣΤΡΑ ΤΖΑΜΙΩΝ ΠΛΑΣΤΙΚΗ ΛΑΒΗ

00949 πλάτος 60 mm 25

GET IT NOW



ΛΕΠΙΔΙ ΓΙΑ ΞΥΣΤΡΑ ΤΖΑΜΙΩΝ

02949 πλάτος 60 mm 200



ΣΤΟΚΑΔΟΡΟΣ ΙΝΟΧ ΞΥΛΙΝΗ ΛΑΒΗ 510

Barcode	πλάτος	Κατηγορία
14415	30 mm	5
13373	40 mm	12
04861	50 mm	12
04862	60 mm	12
04863	70 mm	12
13374	80 mm	12



ΣΤΟΚΑΔΟΡΟΣ ΞΥΛΙΝΗ ΛΑΒΗ 520

Barcode	πλάτος	Κατηγορία
05185	10 mm	12
03174	20 mm	12
04853	30 mm	12
04854	40 mm	12
04855	50 mm	12
04856	60 mm	12
04857	70 mm	12
04858	80 mm	12
04859	100 mm	12



ΣΠΑΤΟΥΛΑ ΙΝΟΧ ΜΕ ΜΥΤΗ ΚΑΤΣΑΒΙΔΙΟΥ ΠΛΑΣΤΙΚΗ ΛΑΒΗ

Barcode	πλάτος	Κατηγορία
13715	150 mm - code: 2783	6



Morgan.



ΣΠΑΤΟΥΛΑ ΞΥΛΙΝΗ ΛΑΒΗ

Barcode	Icon	Code	Quantity
06721		πλάτος 120 mm - code: 9120	6
06722		πλάτος 140 mm - code: 9140	6
06723		πλάτος 160 mm - code: 9160	6
06724		πλάτος 180 mm - code: 9180	6
06725		πλάτος 200 mm - code: 9200	6



L'OUTIL PARFAIT fabricant



ΣΠΑΤΟΥΛΑ ΞΥΛΙΝΗ ΛΑΒΗ 545

Barcode	Icon	Code	Quantity
04866		πλάτος 120 mm	6
04867		πλάτος 140 mm	6
04868		πλάτος 160 mm	6
04869		πλάτος 180 mm	6
04870		πλάτος 200 mm	6
06141		πλάτος 220 mm	6



L'OUTIL PARFAIT fabricant



ΣΠΑΤΟΥΛΑ SOFT LINE ΠΛΑΣΤΙΚΗ ΛΑΒΗ 2604

Barcode	Icon	Code	Quantity
05212		πλάτος 120 mm	6
05213		πλάτος 140 mm	6
05214		πλάτος 160 mm	6
05215		πλάτος 180 mm	6
05216		πλάτος 200 mm	6



L'OUTIL PARFAIT fabricant



ΣΠΑΤΟΥΛΑ ΞΥΛΙΝΗ ΛΑΒΗ 5451

Barcode	Icon	Code	Quantity
13234		πλάτος 120 mm	6
13235		πλάτος 140 mm	6
13236		πλάτος 160 mm	6
13237		πλάτος 180 mm	6
13238		πλάτος 200 mm	6
13239		πλάτος 220 mm	6



L'OUTIL PARFAIT
fabricsant



ΣΠΑΤΟΥΛΑ ΙΝΟΧ ΞΥΛΙΝΗ ΛΑΒΗ 555

Code	Description	Quantity
04871	πλάτος 120mm	6
04872	πλάτος 140mm	6
04873	πλάτος 160mm	6
04874	πλάτος 180mm	6
04875	πλάτος 200mm	6



ΣΠΑΤΟΥΛΕΣ ΣΕΤ 4 τμχ. ΑΤΣΑΛΙΝΕΣ

Code	Description	Quantity
01283	πλάτος 50 / 80 / 100 / 120 mm	10



L'OUTIL PARFAIT
fabricsant



ΣΠΑΤΟΥΛΑ ΚΟΛΛΑΣ ΜΙΚΡΗ ΜΕ ΨΙΛΟ ΔΟΝΤΙ 5621

Code	Description	Quantity
04876	πλάτος 200mm	6



Morgan.



ΣΠΑΤΟΥΛΕΣ ΣΕΤ 4 τμχ. ΑΤΣΑΛΙΝΕΣ 9320

Code	Description	Quantity
06731	πλάτος 50 / 80 / 100 / 120 mm	25



Morgan.



ΣΠΑΤΟΥΛΑ ΚΟΛΛΑΣ 190MM ΜΙΚΡΗ ΜΕ ΔΟΝΤΙ

Code	Description	Quantity
06726	δόντι: 6x6mm - code: 9280	12
01286	δόντι: 10x10mm - code: 9270	12



L'OUTIL PARFAIT
fabricsant



ΣΠΑΤΟΥΛΕΣ ΣΕΤ 4 τμχ. ΑΤΣΑΛΙΝΕΣ 414

Code	Description	Quantity
05950	πλάτος 50 / 80 / 100 / 120 mm	10



Den Braven



ΣΠΑΤΟΥΛΑ ΜΟΡΦΟΠΟΙΗΣΗΣ ΣΙΛΙΚΟΝΗΣ

10657		1



ΣΠΑΤΟΥΛΑ ΘΕΡΜΙΚΟΥ ΣΟΒΑ ΓΩΝΙΑΚΗ 10228

13251	280x130mm	5



ΣΠΑΤΟΥΛΑ ΘΕΡΜΙΚΟΥ ΣΟΒΑ 10224

13250	280x130mm	5

GET IT NOW



13578



13581



ΣΠΑΤΟΥΛΑ ΚΟΛΛΑΣ ΙΝΟΧ 380X130 mm ΜΕ ΔΟΝΤΙ ΞΥΛΙΝΗ ΛΑΒΗ

13578	δόντι: 15x15mm - code: 10272	2
13581	δόντι: 20x20mm - code: 10260	2



13577



13580



ΣΠΑΤΟΥΛΑ ΚΟΛΛΑΣ ΙΝΟΧ 280X130 mm ΜΕ ΔΟΝΤΙ ΠΛΑΣΤΙΚΗ ΛΑΒΗ

13577	δόντι: 15x15mm - code: 10268	5
13580	δόντι: 20x20mm - code: 10270	5

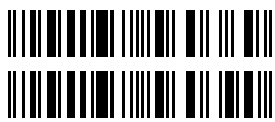

13579



13582



**ΣΠΑΤΟΥΛΑ ΚΟΛΛΑΣ ΙΝΟΧ 480X130 mm
ΜΕ ΔΟΝΤΙ ΞΥΛΙΝΗ ΛΑΒΗ**

13579	δόντι: 15x15mm - code: 10274	2
13582	δόντι: 20x20mm - code: 10244	2



13584



**ΣΠΑΤΟΥΛΑ ΚΟΛΛΑΣ ΧΤΕΝΙ ΙΝΟΧ 380X130 mm
ΞΥΛΙΝΗ ΛΑΒΗ**

13584	δόντι: 20x20mm - code: 10262	2



**ΣΠΑΤΟΥΛΑ ΚΟΛΛΑΣ ΧΤΕΝΙ ΙΝΟΧ 280X130 mm
ΠΛΑΣΤΙΚΗ ΛΑΒΗ**

13583	δόντι: 20x20mm - code: 10264	5



**ΣΠΑΤΟΥΛΑ ΚΟΛΛΑΣ ΧΤΕΝΙ ΙΝΟΧ 480X130 mm
ΞΥΛΙΝΗ ΛΑΒΗ**

13585	δόντι: 20x20mm - code: 10242	2



ΣΠΑΤΟΥΛΕΣ

OUTIL PARFAIT
fabricant



**ΣΠΑΤΟΥΛΑ ΚΟΛΛΑΣ 280X120 mm
 ΜΕ ΔΟΝΤΙ 621**

 05951  δόντι: 10x10mm  12

BELLOTA



**ΣΠΑΤΟΥΛΑ ΚΟΛΛΑΣ 270X130 mm
 ΜΕ ΔΟΝΤΙ 5873**

 01285  δόντι: 10x10mm  6

BELLOTA



**ΣΠΑΤΟΥΛΑ ΚΟΛΛΑΣ 480X135 mm
 ΜΕ ΔΟΝΤΙ 5875**

 03073  δόντι: 10x10mm  6

BELLOTA



ΣΠΑΤΟΥΛΑ ΚΟΛΛΑΣ ΧΩΡΙΣ ΔΟΝΤΙ 5865

 03270  480x150 mm  6

BELLOTA



**ΣΠΑΤΟΥΛΑ ΚΟΛΛΑΣ INOX 270X130 mm
 ΜΕ ΔΟΝΤΙ 25874**

 11091  δόντι: 10x10mm  6

BELLOTA



**ΣΠΑΤΟΥΛΑ ΚΟΛΛΑΣ INOX
 ΧΩΡΙΣ ΔΟΝΤΙ 25864**

 11092  270x130 mm  6

■ NEW ARRIVAL ΝΕΑ ΑΦΙΞΗ ■ HOT SELLER ΚΑΛΥΤΕΡΟ ΣΤΗΝ ΠΩΛΗΣΗ ■ GET IT NOW ΑΞΙΖΕΙ ΝΑ ΑΓΟΡΑΣΕΙΣ ΤΩΡΑ



Μorgan.

ΣΠΑΤΟΥΛΑ ΚΟΛΛΑΣ ΧΩΡΙΣ ΔΟΝΤΙ 9230

06729	280x120mm	6



ΣΠΑΤΟΥΛΑ ΚΟΛΛΑΣ ΧΩΡΙΣ ΔΟΝΤΙ

03269	280x120mm	12



Μorgan.

06728
06727

ΣΠΑΤΟΥΛΑ ΚΟΛΛΑΣ 280X120 mm ΜΕ ΔΟΝΤΙ

06728	δόντι: 6x6mm - code: 9220	6
06727	δόντι: 10x10mm - code: 9210	6



06507
04955

ΣΠΑΤΟΥΛΑ ΚΟΛΛΑΣ 280X120 mm ΜΕ ΔΟΝΤΙ

06507	δόντι: 7x7mm	12
04955	δόντι: 10x10mm	12



Μorgan.

ΣΠΑΤΟΥΛΑ ΚΟΛΛΑΣ 500X140 mm ΜΕ ΔΟΝΤΙ 9250

06735	δόντι: 10x10mm	5



ΣΠΑΤΟΥΛΑ ΚΟΛΛΑΣ 480X140 mm ΜΕ ΔΟΝΤΙ

02231	δόντι: 10x10mm	6



Den Braven



ΕΚΘΕΤΗΡΙΟ ΣΤΕΝΟ

11043 (ΠxBxY) 35,5x51x222cm 1



Den Braven



ΕΚΘΕΤΗΡΙΟ ΓΟΝΔΟΛΑ

11027 (ΠxBxY) 125x60x170cm 1

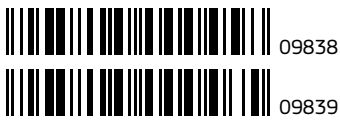

09838



09838



09839

• Ο Zwaluw PU-Foam B3 είναι ένας υψηλής ποιότητας διογκούμενος πολυουρεθανικός αφρός χειρός, ενός συστατικού, σχεδιασμένος για σφράγιση και πλήρωση αρμών, κενών και συνδέσεων.

Κατηγορία πυρανάσχευσης B3.

Ο Zwaluw PU-Foam ωριμάζει με την ατμοσφαιρική υγρασία.

Διάρκεια ζωής: 18 μήνες από την ημερομηνία παραγωγής στην κλειστή αρχική συσκευασία μεταξύ +5°C και +25°C αποθηκευμένο σε στεγνό μέρος.

ΑΦΡΟΣ ΠΟΛΥΟΥΡΕΘΑΝΗΣ PU-FOAM

Barcode	Icon	Icon
09838	300ml - χειρός	12
09839	750ml - χειρός	12

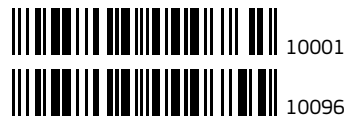

10001



10096



10001

• Ο DB PU Hand-Foam MAXI είναι επαγγελματικός, πολυουρεθανικός αφρός, σχεδιασμένος για σφράγιση μεταξύ στοιχείων σε κατασκευές, για εφαρμογή σε μεγάλο πεδίο θερμοκρασιών.

Ο DB PU Hand-Foam MAXI ωριμάζει με την ατμοσφαιρική υγρασία. Περισσότερη απόδοση από τους κοινούς αφρούς.

Κατηγορία πυρανάσχευσης F.

Διάρκεια ζωής: 18 μήνες από την ημερομηνία παραγωγής στην κλειστή αρχική συσκευασία μεταξύ +5°C και +25°C αποθηκευμένο σε στεγνό μέρος.

ΑΦΡΟΣ ΠΟΛΥΟΥΡΕΘΑΝΗΣ ΧΑΜΗΛΗΣ ΔΙΟΓΚΩΣΗΣ MAXI FOAM 66

Barcode	Icon	Icon
10001	825ml - χειρός	12
10096	825ml - πιστολιού	12



GET IT NOW

• Ο PU Hand-Foam Starfoam B3 είναι ενός συστατικού, υψηλής ποιότητας, διογκούμενος πολυουρεθανικός αφρός χειρός. Σχεδιασμένος για σφράγιση και πλήρωση αρμών, κενών και συνδέσεων. Μετά την εφαρμογή ο αφρός διογκώνεται και ωριμάζει με την ατμοσφαιρική υγρασία.

Κατηγορία πυρανάσχευσης B3.

Διάρκεια ζωής: 18 μήνες από την ημερομηνία παραγωγής στην κλειστή αρχική συσκευασία μεταξύ +5°C και +25°C αποθηκευμένο σε στεγνό μέρος.

ΑΦΡΟΣ ΠΟΛΥΟΥΡΕΘΑΝΗΣ STARSEAL

Barcode	Icon	Icon
09853	700ml - χειρός	12



• Ο Zwaluw PU Gunfoam B2 είναι υψηλής ποιότητας διογκούμενος πολυουρεθανικός αφρός πιστολιού, ενός συστατικού, σχεδιασμένος για σφράγιση και πλήρωση αρμών, κενών και συνδέσεων.

Ωριμάζει με την ατμοσφαιρική υγρασία. Κατηγορία πυρανάσχευσης B2.

Χαμηλή διόγκωση.

Διάρκεια ζωής: 18 μήνες από την ημερομηνία παραγωγής στην κλειστή αρχική συσκευασία μεταξύ +5°C και +25°C αποθηκευμένο σε στεγνό μέρος.

ΑΦΡΟΣ ΠΟΛΥΟΥΡΕΘΑΝΗΣ ΕΛΕΓΧΟΜΕΝΗΣ ΔΙΟΓΚΩΣΗΣ

Barcode	Icon	Icon
10195	750ml - πιστολιού	12



Den Braven

• Ο Zwaluw NBS Gunfoam Starfoam B3 είναι ενός συστατικού επαγγελματικού αφρός πολυουρεθάνης χαμηλής διόγκωσης για εφαρμογές όπου αποκλείονται πιέσεις επέκτασης, όπως κουφώματα παραθύρων, πόρτες, μπαλκονόπορτες, κ.τ.λ. Απορροφά τους κραδασμούς και βελτιώνει την ηχομόνωση. Δημιουργεί θερμοδιακοπή περιμετρικά των κουφωμάτων. Χρησιμοποιείται στην οικοδομή και τη βιομηχανία. Έχει εξαιρετική πρόσφυση σε σκυρόδεμα, τούβλα, πέτρες, γύψο, ξύλο, μέταλλο και πλαστικά.

Δεν συνιστάται για χρήση κάτω από το νερό και η επιφάνεια του πρέπει να προστατεύεται από την ηλιακή ακτινοβολία.

Κατηγορία πυρανάσχεσης B3.

Διάρκεια ζωής: 18 μήνες από την ημερομηνία παραγωγής στην κλειστή αρχική συσκευασία μεταξύ +5°C και +25°C αποθηκευμένο σε στεγνό μέρος.



ΑΦΡΟΣ ΠΟΛΥΟΥΡΕΘΑΝΗΣ ΧΑΜΗΛΗΣ ΔΙΟΓΚΩΣΗΣ NBS GUNFOAM

10190 750ml - πιστολιού 12



Den Braven

• Ο Zwaluw PU Polyesterine είναι ένας χαμηλής διόγκωσης συγκολλητικός αφρός πολυουρεθάνης, ενός συστατικού, για συγκόλληση μονωτικών πλακών συστημάτων θερμοπρόσφυσης σε σκυρόδεμα, σοβά και επιφάνειες τοιχοποιίας. Είναι αδιάβροχος, ελαστικός και μπορεί να σοβατιστεί.

Διάρκεια ζωής: 18 μήνες από την ημερομηνία παραγωγής στην κλειστή αρχική συσκευασία μεταξύ +5°C και +25°C αποθηκευμένο σε στεγνό μέρος.



ΑΦΡΟΣ ΣΥΓΚΟΛΛΗΣΗΣ ΠΟΛΥΣΤΕΡΙΝΗΣ

10524 825ml - πιστολιού 12



Den Braven

• Ο PU-Gunfoam Starfoam B3 έχει σχεδιαστεί για τοποθέτηση κουφωμάτων, αρμούς συνδέσεων γύρω από κουφώματα, κατασκευαστικούς αρμούς, διαχωριστικά τοιχώματα, οροφές, αρμούς δαπέδων, οπές τοιχοποιίας, για εγκατάσταση σωληνώσεων μέσα από τοίχους και πατώματα. Έχει μια εξαιρετική πρόσφυση σε σκυρόδεμα, τούβλα, πέτρες, γύψο, ξύλο, μέταλλο, πλαστικά, πολυστυρένιο, άκαμπτο αφρό PU και σκληρό PVC.

Κατηγορία πυρανάσχεσης B3.

Διάρκεια ζωής: 18 μήνες από την ημερομηνία παραγωγής στην κλειστή αρχική συσκευασία μεταξύ +5°C και +25°C αποθηκευμένο σε στεγνό μέρος.



ΑΦΡΟΣ ΠΟΛΥΟΥΡΕΘΑΝΗΣ ΧΑΜΗΛΗΣ ΔΙΟΓΚΩΣΗΣ STARSEAL

09929 700ml - πιστολιού 12



Den Braven

• Ο NBS PU Cleaner είναι δραστικό καθαριστικό λεκέδων και υπολειμμάτων ενός και δύο συστατικών φρέσκου διογκούμενου πολυουρεθανικού αφρού. Ο στεγνός αφρός δεν διαλύεται, μπορεί να καθαριστεί μόνο με μηχανικά μέσα και Zwaluw Pur Remover. Το Zwaluw Universal-PU Cleaner είναι επίσης κατάλληλο για τον καθαρισμό των πιστολιών εφαρμογής αφρού. Διάρκεια ζωής: 24 μήνες από την ημερομηνία παραγωγής στην κλειστή αρχική συσκευασία μεταξύ +5°C και +25°C αποθηκευμένο σε στεγνό μέρος.



ΚΑΘΑΡΙΣΤΙΚΟ ΓΙΑ ΑΦΡΟ ΠΙΣΤΟΛΙΟΥ

09948 500ml 12



ΠΙΣΤΟΛΙ ΑΦΡΟΥ ΠΟΛΥΟΥΡΕΘΑΝΗΣ



10125



code GSS 5400



1



INTER



NEW
ARRIVAL

ΠΙΣΤΟΛΙ ΑΦΡΟΥ ΠΟΛΥΟΥΡΕΘΑΝΗΣ



07420



code PG-1



2



• Ουδέτερη, άοσμη σιλικόνη πολλαπλών εφαρμογών με διαρκή ελαστικότητα. Καλή πρόσφυση σε πολλές περιοχές χωρίς χρήση ασαριού. Αντέχει σε υπεριώδεις ακτίνες, νερό, υγρασία, ρηγματώσεις. Δεν συρρικνώνεται και δεν επηρεάζει ευαίσθητες επιφάνειες. Κατάλληλη για αρμούς διαστολής, τσιμέντο, τοιχοποιία, συστήματα υαλοπινάκων, τσιμεντένια πάνελ. Δεν συνιστάται για PE, PP, PC, PMMA, PTFE, υλικά ασφαλτικής βάσης ενώ δεν είναι κατάλληλη επίσης για ενυδρεία. Διάρκεια ζωής: 12 μήνες από την ημερομηνία παραγωγής στην κλειστή αρχική συσκευασία μεταξύ +5°C και +25°C αποθηκευμένο σε στεγνό μέρος.



ΣΙΛΙΚΟΝΗ ΟΥΔΕΤΕΡΗ 1001 U-N



09866



310ml - διάφανη



12



09854



10653



09855



10067



10066



14690



• Η Zwaluw Silicone 1001U είναι ενός συστατικού, σιλικόνη, πολλαπλών χρήσεων για κτηριακούς αρμούς, συστήματα υαλοπινάκων, κουζίνες και μπάνια. Εξαιρετική αντοχή στην πλιακή ακτινοβολία και τις καιρικές συνθήκες. Μετά την εφαρμογή της ωριμάζει με την ατμοσφαιρική υγρασία σχηματίζοντας μία μόνιμη ελαστική σφράγιση.

Ενδείκνυται στο κατασκευαστικό τομέα αλλά και για οικιακή χρήση. Υψηλή πρόσφυση σε γυαλί, σμάλτο, κεραμικά πλακίδια, πορσελάνη, πολυεστέρα, ανοξείδωτο χάλυβα, αλουμίνιο, φινιρισμένο ξύλο, καθώς και σε βαμμένες και βερνικωμένες επιφάνειες χωρίς χρήση ασαριού. Δεν συνιστάται για PE, PP, PC, PMMA, PTFE, υλικά ασφαλτικής βάσης ενώ δεν είναι κατάλληλη επίσης για ενυδρεία.

Διάρκεια ζωής: 18 μήνες από την ημερομηνία παραγωγής στην κλειστή αρχική συσκευασία μεταξύ +5°C και +25°C αποθηκευμένο σε στεγνό μέρος.

ΣΙΛΙΚΟΝΗ ΟΞΙΝΗ 1001 U

Barcode	Description	Quantity
09854	280ml - διάφανη	25
09855	280ml - λευκή	25
10066	280ml - γκρι	25
10653	280ml - καφέ	25
10067	280ml - μαύρη	25
14690	550ml - διάφανη	12



10219

09863



09864

09865

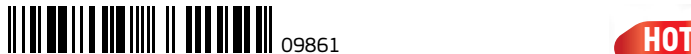

09861

HOT
SELLER

Den Braven

• Η Silicone Starseal είναι ενός συστατικού σιλικόνη για πολλαπλές εφαρμογές. Μετά την εφαρμογή της ωριμάζει με την ατμοσφαιρική υγρασία σχηματίζοντας μία μόνιμη ελαστική σφράγιση. Εξαιρετική αντοχή στην ηλιακή ακτινοβολία και τις καιρικές συνθήκες. Χρησιμοποιείται για σφράγιση σε συστήματα υαλοπινάκων, αρμούς σύνδεσης σε κτήρια, κουζίνες, μπάνια. Διάρκεια ζωής: 18 μήνες από την ημερομηνία παραγωγής στην κλειστή αρχική συσκευασία μεταξύ +5°C και +25°C αποθηκευμένο σε στεγνό μέρος.

**ΣΙΛΙΚΟΝΗ STARSEAL**

Barcode	Quantity	Color	Unit
10219	260ml	διάφανη	25
09864	260ml	λευκή	25
09861	260ml	γκρι	25
09863	260ml	καφέ	25
09865	260ml	μαύρη	25



10051



10183

Den Braven

• Η Zwaluw Silicone-NO είναι ενός συστατικού, αντιμικροβιακή σιλικόνη, ουδέτερης ωρίμανσης, πολλαπλών χρήσεων. Για εφαρμογές σε χώρους υγιεινής, κτηριακές κατασκευές και υαλοπινάκες. Μετά την εφαρμογή της ωριμάζει με την ατμοσφαιρική υγρασία σχηματίζοντας μία μόνιμη ελαστική σφράγιση. Η Zwaluw Silicone-NO χρησιμοποιείται και χωρίς αστάρι, για αρμούς μεταξύ υαλοπινάκων και τοιχοποιίας, περιμετρική σφράγιση μεταξύ υαλοπινάκων και αλουμινίου, για τελική σφράγιση υαλοπετασμάτων, μπάνια, κουζίνες, ντουζιέρες και βιομηχανικούς χώρους όπου πρέπει να αποφεύγεται η ανάπτυξη μούχλας. Διάρκεια ζωής: 12 μήνες από την ημερομηνία παραγωγής στην κλειστή αρχική συσκευασία μεταξύ +5°C και +25°C αποθηκευμένο σε στεγνό μέρος.

**ΣΙΛΙΚΟΝΗ ΟΥΔΕΤΕΡΗ NO-SANITARY**

Barcode	Quantity	Color	Unit
10051	280ml	διάφανη	12
10183	280ml	λευκή	12

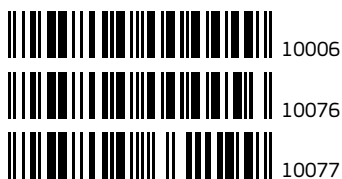

10006



10076



10077

Den Braven

• Η DB Silicone Sanitary DIY είναι ενός συστατικού, αντιμικροβιακή σιλικόνη για χώρους υγιεινής. Μετά την εφαρμογή της ωριμάζει με την ατμοσφαιρική υγρασία σχηματίζοντας μία μόνιμη ελαστική σφράγιση. Εξαιρετική αντοχή στην ηλιακή ακτινοβολία και τις καιρικές συνθήκες. Για αρμολόγηση σε όλα τα είδη υγιεινής, σφράγιση αρμών σε μπάνια, κουζίνες, επαγγελματικούς χώρους, εργαστήρια παρασκευής τροφίμων και σε σημεία όπου θέλουμε να αποφύγουμε την ανάπτυξη μούχλας. Δεν είναι κατάλληλη για ενυδρεία. Δεν βάφεται. Διάρκεια ζωής: 18 μήνες από την ημερομηνία παραγωγής στην κλειστή αρχική συσκευασία μεταξύ +5°C και +25°C αποθηκευμένο σε στεγνό μέρος.

**ΣΙΛΙΚΟΝΗ ΑΝΤΙΜΟΥΧΛΙΚΗ SANITARY DIY**

Barcode	Quantity	Color	Unit
10006	80ml	διάφανη	21
10076	80ml	λευκή	21
10077	80ml	μαύρη	21

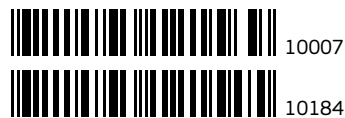

10007



10184

Den Braven

• Η Zwaluw Silicone Sanitary είναι ενός συστατικού, αντιμικροβιακή σιλικόνη για αρμούς ειδών υγιεινής. Εξαιρετική αντοχή στην ηλιακή ακτινοβολία και τις καιρικές συνθήκες. Μετά την εφαρμογή της ωριμάζει με την ατμοσφαιρική υγρασία σχηματίζοντας μία μόνιμη ελαστική σφράγιση. Η Zwaluw Silicone Sanitary χρησιμοποιείται και χωρίς αστάρι, για αρμολογήσεις σε είδη υγιεινής, κουζίνες, ντουζιέρες, μπάνια κλπ. Διάρκεια ζωής: 18 μήνες από την ημερομηνία παραγωγής στην κλειστή αρχική συσκευασία μεταξύ +5°C και +25°C αποθηκευμένο σε στεγνό μέρος.

**ΣΙΛΙΚΟΝΗ ΟΞΙΝΗ SANITARY**

Barcode	Quantity	Color	Unit
10007	280ml	διάφανη	25
10184	280ml	λευκή	25



Den Braven

• Η Zwaluw Aqua-Silicone είναι ενός συστατικού σιλικόνη, υψηλού μέτρου ελαστικότητας, ειδικευμένη για ενυδρεία γλυκού και θαλασσινού νερού. Μετά την εφαρμογή της ωριμάζει με την ατμοσφαιρική υγρασία σχηματίζοντας μία μόνιμη ελαστική σφράγιση.

Δεν είναι τοξική για τους θαλάσσιους οργανισμούς και επιδεικνύει υψηλή αντοχή στις υπεριώδεις ακτίνες το νερό και την υγρασία.

Δεν συνιστάται για ενυδρεία μεγαλύτερα των 1000lt ή ψηλότερα από 60cm. Δεν βάφεται.

Διάρκεια ζωής: 24 μήνες από την ημερομηνία παραγωγής στην κλειστή αρχική συσκευασία μεταξύ +5°C και +25°C αποθηκευμένο σε στεγνό μέρος.



ΣΙΛΙΚΟΝΗ AQUA ΓΙΑ ΕΝΥΔΡΕΙΑ

10068	280ml - διάφανη	12



Den Braven

• Το Zwaluw Mirrorfix-MS είναι ενός συστατικού υβριδικό συγκολλητικό, υψηλής ποιότητας, με μεγάλη αρχική συγκράτηση για καθρέπτες. Είναι άοσμο, ουδέτερο και δεν περιέχει σιλικόνες και ισοκυανικά. Ωριμάζει με την ατμοσφαιρική υγρασία δημιουργώντας μία ισχυρή, διαρκή, ελαστική συγκόλληση, με αντοχή στην υγρασία.

Χρησιμοποιείται για συγκόλληση καθρεπτών σε οικοδομικά στοιχεία. Κατάλληλο για επιφάνειες ξύλου, πέτρας, σοβά, σκυρόδεμα, γυψοσανίδας, μετάλλου, αλουμινίου και πάνω σε καλά βαμμένες επιφάνειες. Συνιστάται δοκιμή πρόσφυσης πριν την εφαρμογή.

Διάρκεια ζωής: 18 μήνες από την ημερομηνία παραγωγής στην κλειστή αρχική συσκευασία μεταξύ +5°C και +25°C αποθηκευμένο σε στεγνό μέρος.



ΣΙΛΙΚΟΝΗ MIRRORFIX-MS

09912	290ml - Λευκή	12



Den Braven

• Η Zwaluw Silicone-BB είναι ενός συστατικού σιλικόνη, χαμηλού μέτρου ελαστικότητας για κτηριακούς αρμούς και υαλοπίνακες.

Εξαιρετική αντοχή στην ηλιακή ακτινοβολία και τις καιρικές συνθήκες. Μετά την εφαρμογή της ωριμάζει με την ατμοσφαιρική υγρασία σχηματίζοντας μία μόνιμη ελαστική σφράγιση.

Χρησιμοποιείται και χωρίς αστάρι, για σφράγιση αρμών σε συστήματα υαλοπινάκων και κτηριακούς αρμούς.

Διάρκεια ζωής: 24 μήνες από την ημερομηνία παραγωγής στην κλειστή αρχική συσκευασία μεταξύ +5°C και +25°C αποθηκευμένο σε στεγνό μέρος.



ΣΙΛΙΚΟΝΗ ΟΞΙΝΗ BB ΓΙΑ ΥΑΛΟΠΙΝΑΚΕΣ

10116	310ml - διάφανη	12



09867



09869



09868



09870

Den Braven

09867



09869



• Η Zwaluw Gasket-Sealant 300°C είναι ενός συστατικού φλατζόκολλα, υψηλής θερμοκρασίας με αντοχή έως 300°C. Μετά την εφαρμογή της ωριμάζει με την ατμοσφαιρική υγρασία σχηματίζοντας μία μόνιμη ελαστική σφράγιση. Χρησιμοποιείται ως φλατζόκολλα σε συναρμολόγηση τμημάτων των μηχανών και γενικότερα για εφαρμογές όπου απαιτείται αντοχή σε πολύ υψηλές θερμοκρασίες. Για σφράγιση μηχανών, κιβωτιών ταχυτήτων, διαφορικών, συστημάτων θέρμανσης, κλιβάνων, θερμοστατών κλπ. Αντοχή στα λάδια, γράσα, αντιψυκτικά. Δεν χρησιμοποιείται σε αρμούς με βάθος μεγαλύτερο των 10mm. Δεν βάφεται.

Διάρκεια ζωής: 18 μήνες από την ημερομηνία παραγωγής στην κλειστή αρχική συσκευασία μεταξύ +5°C και +25°C αποθηκευμένο σε στεγνό μέρος.

ΣΙΛΙΚΟΝΗ HI-TEMP (ΦΛΑΤΖΟΚΟΛΛΑ)

09867	80ml - κόκκινη	21
09869	280ml - κόκκινη	25
09868	80ml - μαύρη	21
09870	280ml - μαύρη	12



ΣΦΡΑΓΙΣΤΙΚΑ



Den Braven

• Το Zwaluw Fire Sealant 1200°C είναι πάστα ανόργανης βάσης που μετά την ωρίμανσή της δημιουργεί μια σκληρή μάζα με αντοχή σε πολύ υψηλές θερμοκρασίες.

Έχει σχεδιαστεί για σφράγιση αρμών σε θερμάστρες, τζάκια, καυστήρες, φούρνους κλπ. Για συγκόλληση και αρμολόγηση πυρότουβλων. Είναι κατάλληλο μόνο για στατικούς αρμούς. Δεν συνίσταται για χρήση κάτω από το νερό, για PE, PP, PC, PMMA, PTFE και επιφάνειες ασφαλιστικής βάσης.

Διάρκεια ζωής: 9 μήνες από την ημερομηνία παραγωγής στην κλειστή αρχική συσκευασία μεταξύ +5°C και +25°C αποθηκευμένο σε στεγνό μέρος.



ΣΦΡΑΓΙΣΤΙΚΟ ΤΖΑΚΙΩΝ FIRE SEALANT 1200°C

09915	280ml - μαύρο	12



09995



09996

Den Braven

• Το Tectane 452 είναι υψηλής ποιότητας, επαγγελματικό, πολυουρεθανικό σφραγιστικό υψηλού μέτρου ελαστικότητας που ωριμάζει με την ατμοσφαιρική υγρασία.

Το Tectane 452 είναι εύκολο στην εφαρμογή με πιστόλι, με εξαιρετική πρόσφυση. Χρησιμοποιείται για αρμούς σύνδεσης διαπέδων και τοίχων εσωτερικά και εξωτερικά και για ελαστική συγκόλληση.

Σε μεταλλικές κατασκευές, σε προκατασκευασμένα σπίτια, οχήματα, container, ψυγεία, αυτοκινούμενα, τροχόσπιτα, τρένα, αεροπλάνα.

Δεν συνίσταται σε υαλοπίνακες, για PE, PP, PC, PMMA, PTFE, επιφάνειες ασφαλιστικής βάσης και ενυδρεία.

Διάρκεια ζωής: 12 μήνες από την ημερομηνία παραγωγής στην κλειστή αρχική συσκευασία μεταξύ +5°C και +25°C αποθηκευμένο σε στεγνό μέρος.



ΣΦΡΑΓΙΣΤΙΚΟ ΠΟΛΥΟΥΡΕΘΑΝΗΣ TECTANE (452)

09995	300ml - λευκό	12
09996	300ml - μαύρο	12



Den Braven

• Το Zwaluw Tixoplast είναι ένα στεγανωτικό με βάση ασφάλτο, το οποίο σκληραίνει σε πλαστική σφράγιση με εξάτμιση του διαλύτη.

Έχει σχεδιαστεί ως συγκολλητικό για ασφαλιστικά κεραμίδια και πάνελ, για αδιαβροχοποίηση αρμών, σε φεγγίτες, μεταλλικές υδρορροές, καμινάδες κλπ. Μπορεί επίσης να χρησιμοποιηθεί για επιδιορθώσεις ανάγκης με βροχή, γέμισμα κενών, σπασιμάτων, φουσκωμάτων επιφανειών, σε οροφές.

Δεν συνίσταται για μόνιμη εμβάπτιση σε νερό. Διάρκεια ζωής: 9 μήνες από την ημερομηνία παραγωγής στην κλειστή αρχική συσκευασία μεταξύ +5°C και +25°C αποθηκευμένο σε στεγνό μέρος.



ΣΦΡΑΓΙΣΤΙΚΟ ΑΣΦΑΛΤΙΚΗΣ ΒΑΣΗΣ ΤΙΧΟΠΛΑΣΤ

10676	310ml - μαύρο	12



Den Braven

• Το Zwaluw Polyflex Facade είναι υψηλής ποιότητας, επαγγελματικό, πολυουρεθανικό σφραγιστικό χαμηλού μέτρου ελαστικότητας που ωριμάζει με την ατμοσφαιρική υγρασία.

Παρέχει εξαιρετική πρόσφυση, υψηλή εφελκυστική αντοχή. Μόνιμα ελαστικό Βάφεται με χρώματα υδατικής βάσης και 2 συστατικών.

Το Zwaluw Polyflex® Facade χρησιμοποιείται για αρμούς διαστολής κτηρίων από σκυρόδεμα, τούβλα και τοιχοποιία. Σε γενικές γραμμές το Zwaluw Polyflex® Facade έχει καλή πρόσφυση, ακόμη και χωρίς αστάρι, στο σκυρόδεμα, πλινθοδομή, βαμμένο ξύλο, γυαλί, γυάλινα υποστρώματα, αλουμίνιο, κάλυβα, ανοξείδωτο κάλυβα, πλαστικά, όπως πολυεστέρα και Uρνc.

Διάρκεια ζωής: 12 μήνες από την ημερομηνία παραγωγής στην κλειστή αρχική συσκευασία μεταξύ +5°C και +25°C αποθηκευμένο σε στεγνό μέρος.



ΣΦΡΑΓΙΣΤΙΚΟ ΠΟΛΥΟΥΡΕΘΑΝΗΣ POLYFLEX FACADE

14575	600ml - λευκό	12

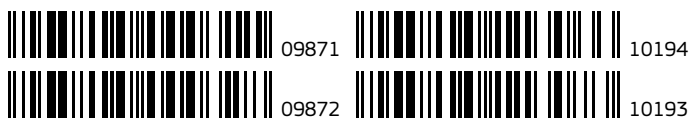

Den Braven



• Το Zwaluw Polyflex 422 είναι υψηλής ποιότητας, επαγγελματικό, πολυουρεθανικό σφραγιστικό χαμηλού μέτρου ελαστικότητας που ωριμάζει με την ατμοσφαιρική υγρασία.

Έχει σχεδιαστεί ως σφραγιστικό για αρμούς διαστολής και σύνδεσης κτηρίων εσωτερικά και εξωτερικά. Υψηλή πρόσφυση σε διάφορα υλικά (τσιμέντο, τοιχοποιία, βαμμένο ξύλο, γυαλί, αλουμίνιο, χάλυβας, PVC και στους περισσότερους συνδυασμούς τους).

Δεν συνίσταται σε υαλοπίνακες, για PE, PP, PC, PMMA, PTFE, επιφάνειες ασφαλτικής βάσης και ενυδρεία.

Διάρκεια ζωής: 12 μήνες από την ημερομηνία παραγωγής στην κλειστή αρχική συσκευασία μεταξύ +5°C και +25°C αποθηκευμένο σε στεγνό μέρος.

ΣΦΡΑΓΙΣΤΙΚΟ ΠΟΛΥΟΥΡΕΘΑΝΗΣ POLYFLEX (422)

Barcode	Volume	Color	Units
09871	300ml	λευκό	12
09872	300ml	γκρι	12
10194	600ml	λευκό	12
10193	600ml	γκρι	12



Den Braven



• Το Zwaluw Hybriseal Facade (ηρώων Hybriseal 540) είναι ενός συστατικού υβριδικό σφραγιστικό υψηλής ποιότητας. Είναι σχεδόν άοσμο χωρίς να περιέχει ισοκυανικά, σιλικόνες και διαλύτες. Ωριμάζει με την ατμοσφαιρική υγρασία σχηματίζοντας μία μόνιμη ελαστική σφράγιση. Έχει σχεδιαστεί ως σφραγιστικό προσώπων κτηρίων για τη σφράγιση αρμών διαστολής, αρμών σύνδεσης και αρμών δαπέδων και έχει πρόσφυση στα περισσότερα οικοδομικά υλικά όπως σκυρόδεμα, τοιχοποιία, βαμμένο ξύλο, σμάλτο, αλουμίνιο, ανοξείδωτο χάλυβα και διάφορα πλαστικά. Ανθεκτικό στην UV ακτινοβολία, τις καιρικές συνθήκες και τη μούχλα. Χωρίς συρρίκνωση και φυσαλίδες.

Διάρκεια ζωής: 15 μήνες από την ημερομηνία παραγωγής στην κλειστή αρχική συσκευασία μεταξύ +5°C και +25°C αποθηκευμένο σε στεγνό μέρος.

ΣΦΡΑΓΙΣΤΙΚΟ ΠΟΛΥΟΥΡΕΘΑΝΗΣ HYBRISEAL FACADE

Barcode	Volume	Color	Units
10202	300ml	λευκό	12
10201	300ml	γκρι	12



Den Braven



• Το Zwaluw Acryl Clear WT είναι υψηλής ποιότητας σχεδόν άοσμο, υπερδιάφανο ακρυλικό σφραγιστικό. Μετά την ωρίμανσή του σχηματίζει μία ανθεκτική, πλαστοελαστική σφράγιση. Λευκό κατά την εφαρμογή του, υπερδιάφανο μετά την ωρίμανση. Έχει σχεδιαστεί για την σφράγιση αρμών στην οικοδομή για αρμούς κουφωμάτων (αλουμινίου και ξύλινων) και τοιχοποιίας, αρμών μεταξύ εσωτερικών σκαλιών και τοίχων, οροφής και τοίχων, σοβατεπί και περβάζια. Εύκολο στη χρήση και το καθάρισμα, δεν διαβρώνει τα μέταλλα. Βάφεται με χρώματα υδατικών και συνθετικών βάσεων.

Για εσωτερικές εφαρμογές.

Δεν συνίσταται για μόνιμη χρήση κάτω από το νερό, για PE, PP, PC, PMMA, PTFE και επιφάνειες ασφαλτικής βάσης.

Διάρκεια ζωής: 18 μήνες από την ημερομηνία παραγωγής στην κλειστή αρχική συσκευασία μεταξύ +5°C και +25°C αποθηκευμένο σε στεγνό μέρος.

ΣΦΡΑΓΙΣΤΙΚΟ ΑΚΡΥΛΙΚΟ ACRYL CLEAR WT

Barcode	Volume	Color	Units
10177	310ml	λευκό	12

	09894		09899
	09895		09900
	09896		09901
	09897		09902
	09898		09903

Den Braven



• Εξαιρετικής ποιότητας σφραγιστικό σε αποχρώσεις ξύλου με βάση ακρυλικές ρητίνες. Μετά την ωρίμανσή του σχηματίζει ένα πλαστοελαστικό σφραγιστικό με πολύ καλή πρόσφυση σε πορώδη υλικά χωρίς χρήση ασταριού. Υψηλή πρόσφυση σε τούβλα, τοιχοποιία, ξύλινες επιφάνειες κλπ. Έχει σχεδιαστεί για τη σφράγιση ξύλινων και laminate δαπέδων, πλαισίων ξύλινων κουφωμάτων, σφράγιση μεταξύ σκάλας και τοιχοποιίας, πέργολες.

Δεν συνιστάται για εφαρμογή σε περιοχές με συνεχή διάβρωση από το νερό, πολυπροπυλένιο, τεφλόν και ασφαλτούχα υποστρώματα.

Διάρκεια ζωής: 30 μήνες από την ημερομηνία παραγωγής στην κλειστή αρχική συσκευασία μεταξύ +5°C και +25°C αποθηκευμένο σε στεγνό μέρος.

ΣΦΡΑΓΙΣΤΙΚΟ ΞΥΛΟΥ ΑΚΡΥΛΙΚΟ 310 ml

09894	βέγκε 2071	12
09895	δρυσ 3501	12
09896	ιρόκο 9901	12
09897	καρυδιά 1231	12
09898	καρυδιά σκούρα 0301	12
09899	κελεμπέκι 2601	12
09900	κερασιά 5601	12
09901	μαόνι σκούρο 7801	12
09902	οξυά 8901	12
09903	πεύκο 3901	12

	09873		10111
	09836		10112
	10069		

Den Braven

**HOT
SELLER**



• Το Acryl 1001 D είναι γενικών εφαρμογών σφραγιστικό ακρυλικής βάσης εξαιρετικής λευκότητας. Μετά την ωρίμανσή του σχηματίζει ένα πλαστο-ελαστικό σφραγιστικό με πολύ καλή πρόσφυση. Έχει σχεδιαστεί για σφράγιση αρμών στην οικοδομή μεταξύ κουφωμάτων (αλουμινίου και ξύλινων) και τοιχοποιίας, αρμών μεταξύ εσωτερικών σκαλιών και τοίχων, οροφής και τοίχων, σοβατεπί και περβάζια. Βαφόμενο με χρώματα υδατικής και συνθετικής βάσης. Έχει εξαιρετική πρόσφυση χωρίς τη χρήση ασταριού ακόμα και σε υγρές επιφάνειες. Είναι άοσμο, εύκολο στη χρήση και στο καθαρίσμα, δεν διαβρώνει τα μέταλλα.

Για εσωτερικές και εξωτερικές εφαρμογές. Δεν συνιστάται για εφαρμογή σε περιοχές με συνεχή διάβρωση από το νερό, σε πολυαιθυλένιο, πολυπροπυλένιο, τεφλόν και ασφαλτούχα υποστρώματα.

Διάρκεια ζωής: 18 μήνες από την ημερομηνία παραγωγής στην κλειστή αρχική συσκευασία μεταξύ +5°C και +25°C αποθηκευμένο σε στεγνό μέρος.

ΣΤΟΚΟΣ ΑΚΡΥΛΙΚΟΣ ACRYL-1001D

09873	280ml - λευκός	25
09836	280ml - γκρι	25
10069	280ml - καφέ	25
10111	400ml - λευκός	12
10112	600ml - λευκός	12



Den Braven

• Το Zwaluw Acryl Exterior+ είναι υψηλής ποιότητας ακρυλικό σφραγιστικό με αντοχή στην βροχή σε σύντομο χρονικό διάστημα μετά την εφαρμογή του. Μετά την ωρίμανσή του σχηματίζει ένα πλαστοελαστικό σφραγιστικό με πολύ καλή πρόσφυση. Κατάλληλο για εσωτερικές και εξωτερικές επιφάνειες, προσφέρει μεγάλη ελαστικότητα και ικανότητα απορρόφησης κίνησης του αρμού, είναι σχεδόν άοσμο και εύκολο στη χρήση και το καθάρισμα, δεν διαβρώνει τα μέταλλα, εφαρμόζεται χωρίς τη χρήση ασταριού ακόμη και σε υγρές επιφάνειες.
Διάρκεια ζωής: 18 μήνες από την ημερομηνία παραγωγής στην κλειστή αρχική συσκευασία μεταξύ +5°C και +25°C αποθηκευμένο σε στεγνό μέρος.



ΣΤΟΚΟΣ ΑΚΡΥΛΙΚΟΣ ACRYL EXTERIOR+

14005 310ml - λευκός 12



Den Braven

• Το Zwaluw Acryl Wet on Wet είναι ένα υψηλής ποιότητας ακρυλικό σφραγιστικό ειδικά σχεδιασμένο να μπορεί να βαφτεί αμέσως μετά την εφαρμογή χωρίς να χρειάζεται να στεγνώσει. Βασίζεται στην τεχνολογία UCA® με εξαιρετική συμβατότητα με χρώματα υδατικής και αλκυδικής βάσης. Το Acryl Wet on Wet δεν αποχρωματίζει την βαφή και αποτρέπει το κρακελάρισμα παραμένοντας ελαστικό μετά την ωρίμανση. Έχει σχεδιαστεί για την σφράγιση αρμών που πρέπει να βαφτούν σε σύντομο χρονικό διάστημα, όπως σκάλες, τοίχους, ταβάνια, σοβατεπί, περβάζια, ξύλινα και μεταλλικά πλαίσια παραθύρων, σκυρόδεμα και τοιχοποιία. Επιπλέον το προϊόν είναι κατάλληλο για γέμισμα ρωγμών, από τρύπες βιδών, και καρφιών σε τοίχους και σε οροφές από ξύλο, σοβά, γύψο, σκυρόδεμα και τούβλα. Εύκολο στη χρήση, άοσμο, δεν διαβρώνει τα μέταλλα.
Διάρκεια ζωής: 12 μήνες από την ημερομηνία παραγωγής στην κλειστή αρχική συσκευασία μεταξύ +5°C και +25°C αποθηκευμένο σε στεγνό μέρος.



ΣΤΟΚΟΣ ΑΚΡΥΛΙΚΟΣ ACRYL WET ON WET

11433 310ml - λευκός 12



Den Braven

• Το Zwaluw Acryl Anti-Crack είναι υψηλής ποιότητας ακρυλικό σφραγιστικό το οποίο βραφεται με χρώματα υδατικής και συνθετικής βάσης και αποτρέπει το φαινόμενο ρηγμάτωσης και αποχρωματισμού της βαφής. Έχει σχεδιαστεί για σφραγίσεις αρμών μεταξύ κουφωμάτων (αλουμινίου και ξύλινων) και τοιχοποιίας, αρμών μεταξύ εσωτερικών σκαλιών και τοίχων, οροφής και τοίχων, σοβατεπί και περβάζια. Εξαιρετική πρόσφυση χωρίς τη χρήση ασταριού ακόμα και σε υγρές επιφάνειες, είναι άοσμο, εύκολο στη χρήση και στο καθάρισμα και δεν διαβρώνει τα μέταλλα. Για εσωτερικές και εξωτερικές εφαρμογές. Δεν συνιστάται για εφαρμογή σε περιοχές με συνεχή διάβρωση από το νερό, σε πολυπροπυλένιο, τεφλόν και ασφαλτούχα υποστρώματα.
Διάρκεια ζωής: 18 μήνες από την ημερομηνία παραγωγής στην κλειστή αρχική συσκευασία μεταξύ +5°C και +25°C αποθηκευμένο σε στεγνό μέρος.



ΣΤΟΚΟΣ ΑΚΡΥΛΙΚΟΣ ANTI-CRACK

10255 310ml - λευκός 12



Den Braven

• Το Acrylic Starseal είναι γενικών εφαρμογών σφραγιστικό ακρυλικής βάσης εξαιρετικής λευκότητας. Μετά την ωρίμανσή του σχηματίζει ένα πλαστοελαστικό σφραγιστικό με πολύ καλή πρόσφυση. Έχει σχεδιαστεί για σφράγιση αρμών στην οικοδομή μεταξύ κουφωμάτων (αλουμινίου και ξύλινων) και τοιχοποιίας, αρμών μεταξύ εσωτερικών σκαλιών και τοίχων, οροφής και τοίχων, σοβατεπί και περβάζια. Βαφόμενο με χρώματα υδατικής και συνθετικής βάσης. Έχει εξαιρετική πρόσφυση χωρίς τη χρήση ασταριού ακόμα και σε υγρές επιφάνειες. Είναι άοσμο, εύκολο στη χρήση και στο καθάρισμα, δεν διαβρώνει τα μέταλλα. Για εσωτερικές και εξωτερικές εφαρμογές. Δεν συνιστάται για εφαρμογή σε περιοχές με συνεχή διάβρωση από το νερό, σε πολυαιθυλένιο, πολυπροπυλένιο, τεφλόν και ασφαλτούχα υποστρώματα.
Διάρκεια ζωής: 18 μήνες από την ημερομηνία παραγωγής στην κλειστή αρχική συσκευασία μεταξύ +5°C και +25°C αποθηκευμένο σε στεγνό μέρος.



ΣΤΟΚΟΣ ΑΚΡΥΛΙΚΟΣ STARSEAL

09874 260ml - λευκός 12

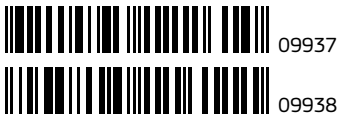

Den Braven



• Το DB Qually Fill είναι έτοιμος προς χρήση, ελαφρύς στόκος με μηδενική συρρίκνωση. Για γέμισμα και επισκευή ρωγμών, οπών, κενών κλπ. Μετά την ωρίμανση μπορεί να τριφτεί και να βαφτεί.

Έχει σχεδιαστεί για το στοκάρισμα με μία εφαρμογή στατικών αρμών σε τοίχους, γυψοσανίδες, σπατουλαρισμένες επιφάνειες, τσιμεντοσανίδες, ξύλινες επιφάνειες κλπ. Δεν συιστάται για εξωτερική χρήση και για σημεία με παρατεταμένη υγρασία.

Διάρκεια ζωής: 12 μήνες από την ημερομηνία παραγωγής στην κλειστή αρχική συσκευασία μεταξύ +5°C και +25°C αποθηκευμένο σε στεγνό μέρος.

ΣΤΟΚΟΣ ΣΠΑΤΟΥΛΑΣ ΕΛΑΦΡΟΣΤΟΚΟΣ QUALY FILL

09937	500ml	12
09938	5lt	1

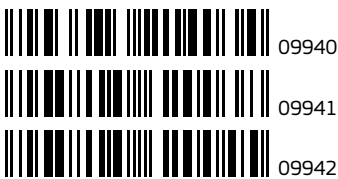

Den Braven



GET IT NOW

• Το Poly-plamuur είναι 2 συστατικών λείος σιδηρόστοκος, γρήγορης ωρίμανσης (15-20 λεπτά), για την επισκευή και λείανση μεταλλικών και πολυεστερικών επιφανειών.

Μετά την ωρίμανση τρίβεται και βάφεται.

Έχει σχεδιαστεί για την επισκευή χτυπημάτων, οπών, σκασιμάτων κλπ. σε μέταλλα και πολυεστερικές επιφάνειες.

Δεν είναι κατάλληλος για χρήση σε πολυαιθυλένιο, πολυπροπυλένιο, τεφλόν και ασφαλτικά υλικά. Να μην εφαρμόζεται σε παχιές στρώσεις. Διάρκεια ζωής: 12 μήνες από την ημερομηνία παραγωγής στην κλειστή αρχική συσκευασία μεταξύ +5°C και +25°C αποθηκευμένο σε στεγνό μέρος.

ΣΙΔΗΡΟΣΤΟΚΟΣ ΓΕΝΙΚΗΣ ΧΡΗΣΗΣ POLY-PLAMUUR

09940	250gr	24
09941	380gr	24
09942	1kg	12

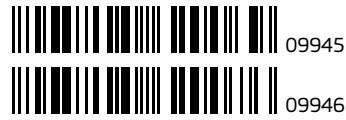

Den Braven



• Κατάλυτης κατάλληλος για μείξη με σιδηρόστοκο και πολυεστερικό στόκο.

ΚΑΤΑΛΥΤΗΣ

09945	8gr	1
09946	20gr	1



Den Braven



• Το DB Vezel-plamuur είναι δύο συστατικών πολυεστερικός στόκος, γρήγορης ωρίμανσης(15-20 λεπτά). Περιέχει ίνες υάλου για ενίσχυση και είναι κατάλληλος για την επισκευή και λείανση μεταλλικών επιφανειών, φυσικής πέτρας, ξύλου, τσιμέντου και πολυεστερικών επιφανειών. Μετά την ωρίμανση τρίβεται και βάφεται. Έχει σχεδιαστεί για την επισκευή χτυπημάτων, οπών, σκασιμάτων κλπ σε μέταλλα, πολυεστερικές επιφάνειες, τσιμέντο, φυσικά πετρώματα και ξύλο. Έξτρα δυνατό, κατάλληλο και για μεγαλύτερα κενά λόγω των πολυεστερικών ινών. Δεν συρρίκνώνεται. Δεν είναι κατάλληλος για χρήση σε πολυαιθυλένιο, πολυπροπυλένιο, τεφλόν και ασφαλτικά υλικά. Να μην εφαρμόζεται σε παχιές στρώσεις.

Διάρκεια ζωής: 12 μήνες από την ημερομηνία παραγωγής στην κλειστή αρχική συσκευασία μεταξύ +5°C και +25°C αποθηκευμένο σε στεγνό μέρος

ΣΤΟΚΟΣ ΠΟΛΥΕΣΤΕΡΙΚΟΣ ΜΕ ΙΝΕΣ VEZEL-PLAMUUR

09944	750gr	12

	11107		10042
	10136		13270
	12354		10652
	11105		10503
	11106		10458
	10234		10137
	10456		10235
	10457		10186
	12712		



• Το DB Wood-Putty είναι χρωματιστός, ακρυλικός ξυλόστοκος για επιδιόρθωση χτυπημάτων, ρωγμών, ατελειών και οπών ξύλινων επιφανειών. Μπορεί να εφαρμοστεί σε πολλαπλές στρώσεις. Μετά την ωρίμανση γυαλοχαρτάρεται, τριπιέται, πριονίζεται, λιμάρεται. Γρήγορη και εύκολη εφαρμογή. Χρησιμοποιείται για επισκευές και επιδιορθώσεις ξύλινων επιφανειών που έχουν σκασίματα, τρύπες, ρωγμές, χτυπήματα κλπ. Δεν συνιστάται για εξωτερική χρήση και για σημεία με παρατεταμένη υγρασία. Διάρκεια ζωής: 24 μήνες από την ημερομηνία παραγωγής στην κλειστή αρχική συσκευασία μεταξύ +5°C και +25°C αποθηκευμένο σε στεγνό μέρος.

ΞΥΛΟΣΤΟΚΟΣ ΑΚΡΥΛΙΚΟΣ ΝΕΡΟΥ 200 gr

11107	βέγκε Νο 19	12
10136	δρυς Νο 9	12
12354	δρυς σκούρα Νο 15	12
11105	καρυδιά ανοικτή Νο 3	12
11106	καρυδιά μέτρια Νο 4	12
10234	καρυδιά σκούρα Νο 5	12
10456	κελεμπέκι Νο 7	12
10457	κερασιά ανοικτή Νο 18	12
12712	κερασιά σκούρα Νο 17	12
10042	λευκό Νο 12	12
13270	μαόνι ανοικτό Νο 1	12
10652	μαόνι σκούρο Νο 2	12
10503	οξιά Νο 11	12
10458	όρεγκον Νο 8	12
10137	πεύκο Νο 6	12
10235	τικ Νο 16	12
10186	φυσικό Νο 10	12



NEW
ARRIVAL



• Το Zwaluw High Tack είναι ενός συστατικού υβριδικό συγκολλητικό, άμεσης συγκράτησης και υψηλής ποιότητας. Λόγω της ισχυρής και άμεσης συγκράτησης η στήριξη των υλικών κατά την εφαρμογή δεν είναι απαραίτητη. Είναι άοσμο, δεν περιέχει ισοκυανικά, σιλκόνες και διαλύτες. Το Zwaluw High Tack έχει σχεδιαστεί ως συγκολλητικό γενικών εφαρμογών οικοδομικών υλικών όπως: πέτρα, σκυρόδεμα, καθρέφτες, γυαλί, γυψοσανίδες, PU, PVC, σκληρό πλαστικό, σμάλτο, κεραμικό, μέταλλα, κράματα, ανοξείδωτο χάλυβα, πάνελ HPL και τσιμεντοσανίδες, ξύλα και βαμμένες επιφάνειες. Διάρκεια ζωής: 18 μήνες από την ημερομηνία παραγωγής στην κλειστή αρχική συσκευασία μεταξύ +5°C και +25°C αποθηκευμένο σε στεγνό μέρος.

ΣΦΡΑΓΙΣΤΙΚΟ-ΣΥΓΚΟΛΛΗΤΙΚΟ HIGH TACK

14419	290ml - λευκό	12



• Το Zwaluw Clear Fix είναι ενός συστατικού, ισχυρό υπερδιάφανο υβριδικό κατασκευαστικό συγκολλητικό, υψηλής ποιότητας. Είναι άοσμο, ουδέτερο και δεν περιέχει ισοκυανικά, σιλκόνες και διαλύτες. Ωριμάζει με την ατμοσφαιρική υγρασία σχηματίζοντας μία ισχυρή, ελαστική συγκόλληση. Έχει σχεδιαστεί ως γενικής χρήσης κατασκευαστικό συγκολλητικό εσωτερικής χρήσης. Κατάλληλο για εφαρμογή σε χώρους παρασκευής και αποθήκευσης τροφίμων. Εξαιρετική πρόσφυση χωρίς αστάρι σε διάφορες επιφάνειες ακόμα και υγρές. Χωρίς συρρίκνωση και φυσαλίδες. Δεν διαβρώνει τα μέταλλα. Δεν συνιστάται για χρήση κάτω από το νερό, για PE, PP, PTFE νεοπρένιο και επιφάνειες ασφαλτικής βάσης. Διάρκεια ζωής: 12 μήνες από την ημερομηνία παραγωγής στην κλειστή αρχική συσκευασία μεταξύ +5°C και +25°C αποθηκευμένο σε στεγνό μέρος.

ΣΦΡΑΓΙΣΤΙΚΟ-ΣΥΓΚΟΛΛΗΤΙΚΟ ΥΠΕΡΔΙΑΦΑΝΟ CLEARFIX

09361	290ml	12



• Το Zwaluw Hybridix είναι ενός συστατικού, ισχυρό υβριδικό συγκολλητικό/σφραγιστικό, υψηλής ποιότητας. Ωριμάζει με την ατμοσφαιρική υγρασία σχηματίζοντας μία ισχυρή, ελαστική συγκόλληση. Είναι άοσμο, ουδέτερο και δεν περιέχει ισοκυανικά. Έχει σχεδιαστεί ως γενικής χρήσης σφραγιστικό για μόνιμα ελαστική σφράγιση αρμών σύνδεσης, αρμών διαπιδίων στην βιομηχανία και την κατασκευή. Κατάλληλο για μέταλλα, συνθετικά υλικά, τσιμεντοκονία, ξύλο, γυαλί, γυψοσανίδα, πολυουρεθάνη, σκληρά πλαστικά, βαμμένες επιφάνειες, κεραμικά, χαλκό, μόλυβδο, γαλβανισμένες επιφάνειες, αλουμίνιο, ελαφριά κράματα, ανοξείδωτο, τσιμεντοσανίδα και πάνελ HPL. Εσωτερική και εξωτερική χρήση. Ανθεκτικό στην UV ακτινοβολία, τις καιρικές συνθήκες και τη μούχλα. Υψηλή δύναμη, μηχανική αντοχή και σκληρότητα. Χωρίς συρρίκνωση και φυσαλίδες. Δεν συνίσταται για μόνιμη χρήση κάτω από το νερό, για PE, PP, PC, PMMA, PTFE και επιφάνειες ασφαλτικής βάσης. Διάρκεια ζωής: 18 μήνες από την ημερομηνία παραγωγής στην κλειστή αρχική συσκευασία μεταξύ +5°C και +25°C αποθηκευμένο σε στεγνό μέρος.

ΣΦΡΑΓΙΣΤΙΚΟ-ΣΥΓΚΟΛΛΗΤΙΚΟ HIBRIFIX

Barcode	Icon	Product Name	Volume	Color	Units
09904		80ml - Λευκό	25		
09906		290ml - Λευκό	12		
09905		290ml - Γκρι	12		
09907		290ml - Μαύρο	12		



• Το Zwaluw Montagefix-590 είναι μονταζκόλλα πολυουρεθάνης πολύ υψηλών προδιαγραφών και ταχείας ωρίμανσης, χωρίς διαλύτες. Κατάλληλη και για κάθετες εφαρμογές λόγω της μεγάλης θιξοτροπίας. Ωριμάζει με την ατμοσφαιρική υγρασία σχηματίζοντας μία διαρκή, ισχυρή, με αντοχή στην υγρασία, συγκόλληση. Έχει σχεδιαστεί για την συγκόλληση σε ξύλο, μέταλλο, πέτρα, τσιμέντο, πλαστικό και μονωτικά υλικά όπως αφρό πολυουρεθάνης, πετροβάμβακα και υαλοβάμβακα. Εξαιρετική πρόσφυση χωρίς την χρήση ασταριού ακόμα και σε υγρές επιφάνειες. Δεν συνίσταται για χρήση κάτω από το νερό. Διάρκεια ζωής: 9 μήνες από την ημερομηνία παραγωγής στην κλειστή αρχική συσκευασία μεταξύ +5°C και +25°C αποθηκευμένο σε στεγνό μέρος.

ΚΟΛΛΑ MONTAGE FIX-590

Barcode	Icon	Product Name	Volume	Color	Units
09914		300ml - Μνεζ	25		



• Το Zwaluw Montagefix-W είναι μονταζκόλλα υδατικής βάσης, πολλαπλών εφαρμογών, χωρίς διαλύτες. Ωριμάζει με την εξάτμιση του νερού σχηματίζοντας μία διαρκή, ισχυρή, με αντοχή στην υγρασία, συγκόλληση. Έχει σχεδιαστεί για την συγκόλληση, συναρμολόγηση και στερέωση υλικών όπως: ξύλινα σοβατεπί, κανάλια καλωδίων, αρμοκάλυπτρα, διακοσμητικές πέτρες, κορνίζες, φελιζόλ κλπ. σε τοιχοποιία, τσιμέντο, τούβλο, τσιμεντοσανίδα. Είναι κατάλληλο για συγκόλληση διακοσμητικών στοιχείων πολυστερίνης (EPS και XPS). Δεν περιέχει διαλύτες, δεν διαβρώνει τα μέταλλα, είναι εύκολο στη χρήση και στο καθαίρισμα, βάφεται με χρώματα υδατικής και συνθετικής βάσης. Για εσωτερική χρήση. Διάρκεια ζωής: 12 μήνες από την ημερομηνία παραγωγής στην κλειστή αρχική συσκευασία μεταξύ +5°C και +25°C αποθηκευμένο σε στεγνό μέρος.

ΚΟΛΛΑ MONTAGE FIX-W

Barcode	Icon	Product Name	Volume	Color	Units
09913		280ml - Λευκό	12		



• Το Zwaluw Montagefix-N είναι συγκολλητικό ενός συστατικού, υψηλής απόδοσης επαγγελματικό από ρητίνη συνθετικού καουτσούκ. Ωριμάζει με την εξάτμιση του διαλύτη σχηματίζοντας μία διαρκή ισχυρή συγκόλληση. Έχει σχεδιαστεί για την συγκόλληση διακοσμητικών πάνελ, ξύλινων δοκαριών, σοβατεπί, άκρων σκαλοπατιών, ξύλινων φιλέτων κλπ. Κατάλληλο επίσης για συγκόλληση μετάλλων, ξύλου, κεραμικών, τσιμέντου σκληρό PVC και φυσικών πετρωμάτων. Διάρκεια ζωής: 12 μήνες από την ημερομηνία παραγωγής στην κλειστή αρχική συσκευασία μεταξύ +5°C και +25°C αποθηκευμένο σε στεγνό μέρος.

ΚΟΛΛΑ MONTAGE FIX-N

Barcode	Icon	Product Name	Volume	Color	Units
12865		280ml - Μνεζ	12		





10666

10607



ΕΚΘΕΤΗΡΙΟ ΚΟΛΛΑΣ ΜΑΜΟΥΤ (ΣΩΛΗΝΑΡΙΟ)

10666	300x160x580	1



ΕΚΘΕΤΗΡΙΟ ΚΟΛΛΑΣ ΜΑΜΟΥΤ (ΦΥΣΙΓΓΙΟ)

10607	260x170x560	1

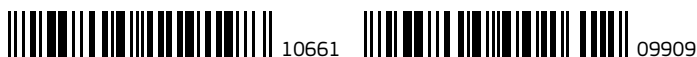

10661

09909



Το DB Mamut Glue είναι ένα ισχυρό συγκολλητικό άμεσης συγκράτησης, τεχνολογίας MS-Polymer. Λόγω των ιδιοτήτων του, η στήριξη των υλικών στην εφαρμογή δεν είναι απαραίτητη. Είναι άοσμο, ουδέτερο και δεν περιέχει διαλύτες. Δεν επηρεάζει τις ευαίσθητες επιφάνειες. Αντοχή σε εφελκυσμό μετά την ωρίμανση 2,2Nmm² / cm². Αντικαθιστά καρφιά και βίδες. Ενδείκνυται για συγκόλληση μονωτικών υλικών, καθρεπτών, μετάλλων, γυαλιού, πορσελάνης, αλουμινίου, μόλυβδου, βερνικωμένου ξύλου, ανοξείδωτου χάλυβα, πολυεστέρα, πολυουρεθάνης, PVC, φυσικών πετρών, γυψοσανίδας, σκυροδέματος κλπ. Διάρκεια ζωής: 18 μήνες από την ημερομηνία παραγωγής στην κλειστή αρχική συσκευασία μεταξύ +5°C και +25°C αποθηκευμένο σε στεγνό μέρος.

ΚΟΛΛΑ ΜΑΜΟΥΤ ΑΜΕΣΗΣ ΣΥΓΚΡΑΤΗΣΗΣ

10661	25ml	25
09909	290ml	12





Den Braven

• Το DB Mamut Glue Crystal είναι υπερδιάφανο, ισχυρό κατασκευαστικό συγκολλητικό υψηλής ποιότητας τεχνολογίας MS Polymer. Είναι άοσμο, ουδέτερο και δεν περιέχει ισοκυανικά. Ωριμάζει με την ατμοσφαιρική υγρασία σχηματίζοντας μία ισχυρή, ελαστική, κρυστάλλινη συγκόλληση. Ενδείκνυται ως γενικής χρήσης κατασκευαστικό συγκολλητικό για εφαρμογές σε κτίρια, μπάνια, κουζίνες, συστήματα εσωτερικών υαλοπινάκων και βερνικωμένων επιφανειών, για πορσελάνες, κεραμικά πλακάκια, ανοξείδωτο χάλυβα, χαλκό, μόλυβδο, κλπ.

Διάρκεια ζωής: 18 μήνες από την ημερομηνία παραγωγής στην κλειστή αρχική συσκευασία μεταξύ +5°C και +25°C αποθηκευμένο σε στεγνό μέρος.



ΚΟΛΛΑ MAMUT ΥΠΕΡΔΙΑΦΑΝΗ CRYSTAL

09910	290ml	12



Den Braven

• Το DB Mamut Glue Total είναι ενός συστατικού, εξαιρετικής ποιότητας, επαγγελματικό συγκολλητικό MS Polymer, με πολύ υψηλή εφελκυστική αντοχή. Ωριμάζει με την ατμοσφαιρική υγρασία σχηματίζοντας μία εξαιρετικά ισχυρή, ελαστική συγκόλληση. Αντοχή σε εφελκυσμό μετά την ωρίμανση 4.0N/mm². Αντικαθιστά καρφιά και βίδες. Ενδείκνυται για την συγκόλληση πολλών κατασκευαστικών υλικών όπως σίδερο, ανοξείδωτο, αλουμίνιο, ανοδιωμένο αλουμίνιο, χαλκό, γαλβανισμένη λαμαρίνα, ελαφριά κράματα, PU, ABS, PVC, πολυστερίνη, πολυεστέρα, γυαλί, τσιμεντοκονία, φυσικές πέτρες, γύψο, βαμμένες επιφάνειες, κεραμικά. Εφαρμογές σε αυτοκίνητα, αυτοκινούμενα, τροχόσπιτα, μηχανήματα, αεραγωγούς, προσόψεις, γυαλί, μεταλλικές κατασκευές, πλαίσια παραθύρων, βιομηχανικά πάνελ, κλιματιστικά, στην ναυτιλία κλπ.

Διάρκεια ζωής: 18 μήνες από την ημερομηνία παραγωγής στην κλειστή αρχική συσκευασία μεταξύ +5°C και +25°C αποθηκευμένο σε στεγνό μέρος.



ΚΟΛΛΑ MAMUT ΠΟΛΛΑΠΛΩΝ ΕΦΑΡΜΟΓΩΝ TOTAL

09911	290ml	12



Den Braven

• Το DB Mamut Multi είναι μοναδικό συγκολλητικό/σφραγιστικό πολλαπλών εφαρμογών, βασισμένο στην τεχνολογία MS Polymer. Ξεχωρίζει για την υψηλή τελική συγκόλληση μετά από πλήρη ωρίμανση: 22 kg/cm². Μπορεί να εφαρμοστεί σε ελαφρά υγρές επιφάνειες. Έχει σχεδιαστεί για την συγκόλληση ξύλου, γυψοσανίδας, κόντρα πλακέ, πέτρες, μπετόν, τούβλων, κεραμικών, γυαλιού, μετάλλου και άλλων οικοδομικών υλικών. Για εσωτερικούς και εξωτερικούς χώρους. Κατάλληλο για τη σφράγιση αρμών (διάκενα), παραθύρων, πλαισίων πόρτας. Συγκόλληση σε πατώματα, σκάλες, περβάγια παραθύρων, πλακάκια. Μπορεί να χρησιμοποιηθεί και για συγκολλήσεις σε χώρους υγιεινής (κουζίνες, μπάνια) και σε μεταλλικές κατασκευές.

Διάρκεια ζωής: 18 μήνες από την ημερομηνία παραγωγής στην κλειστή αρχική συσκευασία μεταξύ +5°C και +25°C αποθηκευμένο σε στεγνό μέρος.



ΚΟΛΛΑ MAMUT ΠΟΛΛΑΠΛΩΝ ΕΦΑΡΜΟΓΩΝ MULTI

13908	290ml	12



Den Braven

• Το DB Woodfix PU D4 χρησιμοποιείται ως συγκολλητικό με αντοχή στο νερό για εφαρμογές που έρχονται σε επαφή με νερό και υγρασία για μεγάλα χρονικά διαστήματα. Κατάλληλο για εξωτερικές εφαρμογές εφόσον καλυφθεί με κάποια βαφή για προστασία από την ηλιακή ακτινοβολία. Για χρήση ως κόλλα γωνιάστρας σε όλους τους τύπους κουφωμάτων. Για κατασκευές σάντουιτς.

Διάρκεια ζωής: 12 μήνες από την ημερομηνία παραγωγής στην κλειστή αρχική συσκευασία μεταξύ +5°C και +25°C αποθηκευμένο σε στεγνό μέρος.



ΞΥΛΟΚΟΛΛΑ ΑΔΙΑΒΡΟΧΗ ΠΟΛΥΟΥΡΕΘΑΝΗΣ PU D4

09916	500ml - μπιμπερό	12



• Η DB Woodfix D2 είναι μια ισχυρή κόλλα ξύλου ταχείας πήξεως, κρυσταλλιζέ με βάση PVAC.

Ωριμάζει με την εξάτμιση του νερού σχηματίζοντας μία διάφανη συγκόλληση. Έχει σχεδιαστεί για συγκολλήσεις σε ξύλινες εφαρμογές όπως τραπέζια, καρέκλες, συρτάρια, ενώσεις ξύλων, φορμάκιας, νοβοπάν,καπλαμά, φελιζόλ, φελλού κλπ. Κατάλληλη επίσης, για συγκόλληση χαρτονιού, χαρτιού κλπ. Διάρκεια ζωής: 18 μήνες από την ημερομηνία παραγωγής στην κλειστή αρχική συσκευασία μεταξύ +5°C και +25°C αποθηκευμένο σε στεγνό μέρος.

ΞΥΛΟΚΟΛΛΑ ΤΑΧΕΙΑΣ ΠΗΞΕΩΣ D2

Barcode	Quantity	Unit
09884	200gr - μιπιπερό	24
09885	500gr	24
09886	750gr - μιπιπερό	12
09887	1kg	12
09888	5kg	1
09889	30kg	1



• Η DB Woodfix D3 είναι μία ισχυρή αδιάβροχη κόλλα ξύλου, ταχείας πήξεως, βάσης PVAC.

Ωριμάζει με την εξάτμιση του νερού σχηματίζοντας μία διάφανη συγκόλληση.

Σχεδιασμένη για εσωτερική και εξωτερική χρήση σε σημεία που δεν είναι εκτεθειμένα στις καιρικές συνθήκες. Διάρκεια ζωής: 18 μήνες από την ημερομηνία παραγωγής στην κλειστή αρχική συσκευασία μεταξύ +5°C και +25°C αποθηκευμένο σε στεγνό μέρος.

ΞΥΛΟΚΟΛΛΑ ΑΔΙΑΒΡΟΧΗ ΤΑΧΕΙΑΣ ΠΗΞΕΩΣ D3

Barcode	Quantity	Unit
09890	200gr - μιπιπερό	24
09891	750gr - μιπιπερό	12
09892	5kg	1
09893	30kg	1



• Η DB Contact Adhesive No 110 είναι μια ισχυρή βενζινόκολλα υψηλών προδιαγραφών χωρίς τολουόλη για γενική χρήση σε εσωτερικούς και εξωτερικούς χώρους.

Έχει σχεδιαστεί για την συγκόλληση ξύλου, MDF, HDF, φελλό, πολυστυρένιο, PVC και παρόμοια υλικά (εκτός από PE, PP), κεραμικά, γύψο, χάλυβα, πτυσσόμενες σανίδες, κιβώτια, κατώφλια, κρεμάστρες, σανίδες, διακόσμηση κτλ. Διάρκεια ζωής: 18 μήνες από την ημερομηνία παραγωγής στην κλειστή αρχική συσκευασία μεταξύ +5°C και +25°C αποθηκευμένο σε στεγνό μέρος.

BENZINOKOΛΛA 110

Barcode	Quantity	Unit
07680	60ml - σωληνάριο	25
11324	100gr	10
10531	185gr	10
11325	410gr	6
08813	860gr	12
11326	4,6kg	1

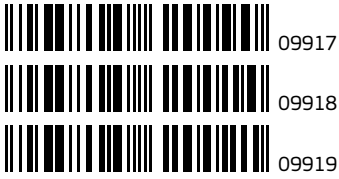

Den Braven



• Η DB PVC Glue είναι ισχυρή κόλλα για συγκόλληση και σφράγιση σωληνώσεων αποχέυσης.

Έχει μεγάλη αντοχή στο ζεστό και κρύο νερό, τις υδραυλικές πιέσεις και χημικά.

Διάρκεια ζωής: 12 μήνες από την ημερομηνία παραγωγής στην κλειστή αρχική συσκευασία μεταξύ +5°C και +25°C αποθηκευμένο σε στεγνό μέρος.

ΚΟΛΛΑ ΓΙΑ ΣΩΛΗΝΕΣ PVC

Barcode	Quantity	Unit
09917	125ml - σωληνάριο διάφανο	25
09918	250ml - γκρι	24
09919	500ml - γκρι	12

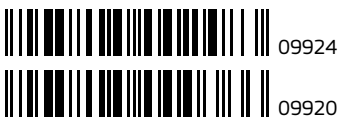

Den Braven



• Η DB Super Adhesive είναι μία ισχυρή, κυανοακρυλική κόλλα, υψηλών προδιαγραφών και ταχύτατης ωρίμανσης.

Ωριμάζει όταν έρχεται σε επαφή με την ατμοσφαιρική υγρασία.

Έχει σχεδιαστεί για την συγκόλληση μετάλλου, γυαλιού, πλαστικού, λάστικου κλπ. Χρήση στον μοντελισμό, σε κοσμήματα, στολίδια και περιμετρικά σε λάστιχα κουφωμάτων.

Διάρκεια ζωής: 12 μήνες (φιαλίδιο) & 18 μήνες (σωληνάριο) από την ημερομηνία παραγωγής στην κλειστή αρχική συσκευασία μεταξύ +5°C και +25°C αποθηκευμένο σε στεγνό μέρος.

ΚΟΛΛΑ ΣΤΙΓΜΗΣ ΓΕΝΙΚΗΣ ΧΡΗΣΗΣ

Barcode	Quantity	Unit
09924	3gr - σωληνάριο	12
09920	20gr - φιαλίδιο	25



Bostik
smart adhesives

BLISTER



• Το Bostik Epoxy FIX METAL είναι ένα εξαιρετικά ισχυρό συγκολλητικό μετάλλων 2 συστατικών σε σύριγγα, χωρίς διαλύτες, με αντοχή σε υψηλές θερμοκρασίες, νερό και λάδια. Κατάλληλο για εφαρμογές σε σχεδόν όλα τα μέταλλα όπως σίδηρο, ασάλι, αλουμίνιο, χαλκό και μπρούτζο. Τρίβεται και βάφεται μετά την ωρίμανσή του.

Χρησιμοποιείται για επισκευές αντικειμένων στο σπίτι, το γραφείο, αλλά και για επαγγελματικές εφαρμογές.

Διάρκεια ζωής: 24 μήνες από την ημερομηνία παραγωγής στην κλειστή αρχική συσκευασία μεταξύ +5°C και +25°C αποθηκευμένο σε στεγνό μέρος.

ΚΟΛΛΑ ΕΠΟΞΙΚΗ 5MIN 2 ΣΥΣΤΑΤΙΚΩΝ EPOXY FIX METAL

Barcode	Quantity	Unit
09922	25ml - σύριγγα	6



• Το Bostik Epoxy FIX EXPRESS είναι ένα πανίσχυρο συγκολλητικό γενικής χρήσης 2 συστατικών σε σύριγγα. Δεν περιέχει διαλύτες, με αντοχή σε υψηλές θερμοκρασίες, νερό και λάδια. Ιδανικό για εφαρμογές σε μέταλλα, ξύλα, τοιχοποιία, κεραμικά, γυαλί, δέρματα, λάστιχα, μοριοσανίδες, τσιμέντο, χαρτόνι, υφάσματα και στα περισσότερα πλαστικά. Τρίβεται και βάφεται μετά την ωρίμανσή του. Χρησιμοποιείται για επισκευές αντικειμένων στο σπίτι, το γραφείο, αλλά και για επαγγελματικές εφαρμογές. Διάρκεια ζωής: 24 μήνες από την ημερομηνία παραγωγής στην κλειστή αρχική συσκευασία μεταξύ +5°C και +25°C αποθηκευμένο σε στεγνό μέρος.

ΚΟΛΛΑ ΕΠΟΞΙΚΗ 90SEC 2 ΣΥΣΤΑΤΙΚΩΝ EPOXY FIX EXPRESS

09921	25ml -σύριγγα	6



10331



10330

10331

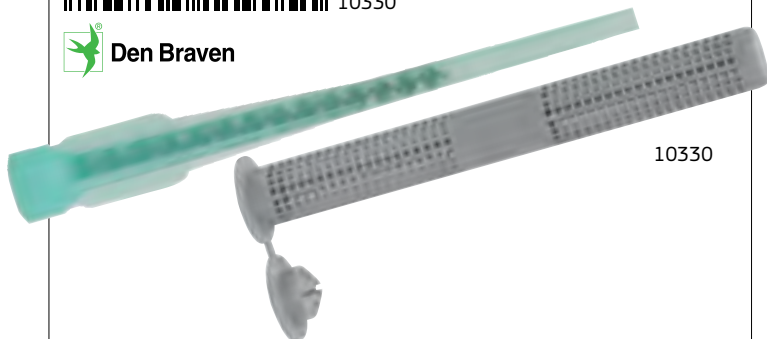

10330

ΕΞΑΡΤΗΜΑΤΑ ΓΙΑ ΧΗΜΙΚΟ ΒΥΣΜΑ

10331	ακροφύσιο - σετ 3 τμχ	1
15358	πλέγμα (Φ15x85 mm) - σετ 5 τμχ	1



• Το DB Polyester Chemical Anchor είναι δύο συστατικών επαγγελματικό χημικό σύστημα αγκύρωσης πολυεστερικής βάσης. Εξαιρετικής ποιότητας, χωρίς στυρένιο. Για γρήγορη εφαρμογή με ισχυρή συγκράτηση. Σταθεροποιεί ντίζες και μπουζόνια σε δομικά στοιχεία. Άοσμο και εύκολο στην εφαρμογή. Υψηλή αντοχή σε μεγάλα φορτία. Σύμφωνα με ETAG 001. Έχει σχεδιαστεί για την χημική αγκύρωση ντιζών και μπουζονιών σε μεταλλικές κατασκευές όπως: κολώνες, κάγκελα, τέντες, πινακίδες, ράφια, κλιματιστικά, κεραίες, φώτα κλπ. Μπορεί να χρησιμοποιηθεί σε εσωτερικές και εξωτερικές εφαρμογές κάθετα και οριζόντια. Γρήγορη ωρίμανση, δυνατή συγκράτηση, για διάτρητα και συμπαγή δομικά υλικά, έτοιμο προς χρήση, για ντίζες M8 έως M24. Εφαρμόζεται σε αλκαλικό περιβάλλον, και σε χαμηλές θερμοκρασίες έως -5°C . Το DB Polyester Chemical Anchor μπορεί χρησιμοποιηθεί σε όλη τη συνιστώμενη περίοδο χρήσης, απλώς αντικαθιστώντας το ακροφύσιο εφαρμογής. Διαθέτει 2 ακροφύσια. Μετά την εφαρμογή πρέπει να κλείνεται το φυσιγγίο με το καπάκι ασφαλείας. Διάρκεια ζωής: 18 μήνες τουλάχιστον από την ημερομηνία παραγωγής στην κλειστή αρχική συσκευασία μεταξύ +5°C και +25°C αποθηκευμένο σε στεγνό μέρος.

ΧΗΜΙΚΟ ΒΥΣΜΑ POLYESTER

10265	300ml	12



ΕΚΘΕΤΗΡΙΟ ΣΤΕΝΟ

13907	60x40x200 cm	1



• Η κόλλα LASTOFOAM STYRENE ADHESIVE χρησιμοποιείται για την κόλληση πλακών από εξηλασμένη ή διογκωμένη πολυστερίνη με την επιφάνεια εφαρμογής του συστήματος.
Ενδείκνυται τόσο για εσωτερική όσο και για εξωτερική χρήση.
Έχει εξαιρετική πρόσφυση σε σοβάδες, τούβλα, κονιάματα, άσφαλτο, ξύλο, hardboard, γύψο, χαρτόνι και μέταλλα.
Διάρκεια ζωής: 12 μήνες τουλάχιστον από την ημερομηνία παραγωγής στην κλειστή αρχική συσκευασία μεταξύ +5°C και +25°C αποθηκευμένο σε στεγνό μέρος.

ΑΦΡΟΣ ΣΥΓΚΟΛΛΗΣΗΣ ΠΟΛΥΣΤΕΡΙΝΗΣ LASTOFOAM STYRENE

12919	830ml - πιστολιού	12



• Αφρός πολυουρεθάνης βραδύκαυστος για πλήρωση κενών, ρωγμών και οπών. Παρουσιάζει υψηλή αντοχή στη φωτιά εμποδίζοντας τη διάδοση σε περιπτώσεις πυρκαγιάς.
Είναι κατάλληλος για τοποθέτηση πορτών και κουφωμάτων πυρασφαλείας. Είναι επίσης κατάλληλος για γεμίματα και στερεώσεις όπου υπάρχει απαίτηση για χρήση υλικών με βραδύκαυστες ιδιότητες.
Διάρκεια ζωής: 12 μήνες τουλάχιστον από την ημερομηνία παραγωγής στην κλειστή αρχική συσκευασία μεταξύ +5°C και +25°C αποθηκευμένο σε στεγνό μέρος.

ΑΦΡΟΣ ΠΟΛΥΟΥΡΕΘΑΝΗΣ ΒΡΑΔΥΚΑΥΣΤΟΣ LASTOFOAM B1

13572	750ml - πιστολιού	12

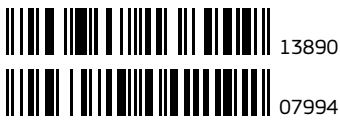

13890



07994



• Είναι κατάλληλος για γεμίματα οπών μεταξύ τοιχείων και σωληνώσεων και κενών ανάμεσα σε κουφώματα και τοιχοποιία. Ενδείκνυται για την τοποθέτηση και στερέωση κουφωμάτων και κασών για πόρτες. Χρησιμοποιείται επίσης και για μόνωση σε στέγες από κεραμίδια. Διάρκεια ζωής: 12 μήνες τουλάχιστον από την ημερομηνία παραγωγής στην κλειστή αρχική συσκευασία μεταξύ +5°C και +25°C αποθηκευμένο σε στεγνό μέρος.



ΑΦΡΟΣ ΠΟΛΥΟΥΡΕΘΑΝΗΣ LASTOFOAM

Barcode	Volume	Unit
13890	750ml - χειρός	12
07994	750ml - πιστολιού	12

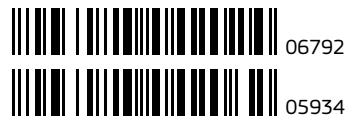

06792



05934



• Είναι κατάλληλος για γεμίματα οπών μεταξύ τοιχείων και σωληνώσεων και κενών ανάμεσα σε κουφώματα και τοιχοποιία. Ενδείκνυται για την τοποθέτηση και στερέωση κουφωμάτων και κασών για πόρτες. Χρησιμοποιείται επίσης και για μόνωση σε στέγες από κεραμίδια. Διάρκεια ζωής: 12 μήνες τουλάχιστον από την ημερομηνία παραγωγής στην κλειστή αρχική συσκευασία μεταξύ +5°C και +25°C αποθηκευμένο σε στεγνό μέρος.



HOT SELLER

ΑΦΡΟΣ ΠΟΛΥΟΥΡΕΘΑΝΗΣ ISOFIX

Barcode	Volume	Unit
06792	300ml - χειρός	12
05934	700ml - χειρός	12

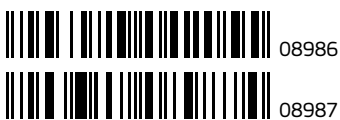

08986



08987



• Είναι κατάλληλος για τοποθέτηση παραθύρων και πόρτων, για τοποθέτηση ξύλινων σκαλών και περβαζιών, για γέμισμα τρυπών, ρωγμών, αρμών και ανοιγμάτων. Είναι επίσης κατάλληλος για σφράγιση ανοιγμάτων σε σκεπές και μονωτικά υλικά, για γέμισμα τρυπών γύρω από σωλήνες, κ.α. Διάρκεια ζωής: 12 μήνες τουλάχιστον από την ημερομηνία παραγωγής στην κλειστή αρχική συσκευασία μεταξύ +5°C και +25°C αποθηκευμένο σε στεγνό μέρος.



HOT SELLER

ΑΦΡΟΣ ΠΟΛΥΟΥΡΕΘΑΝΗΣ ΧΑΜΗΛΗΣ ΔΙΟΓΚΩΣΗΣ

Barcode	Volume	Unit
08986	750ml - χειρός	12
08987	750ml - πιστολιού	12



• Lastofoam 2 in 1. Ένας αφρός πολυουρεθάνης με πρωτοποριακή συσκευασία: μπορεί να χρησιμοποιηθεί με το χέρι αλλά και με πιστόλι. εύκολος στη χρήση, οικονομικός και με μεγαλύτερη ακρίβεια λόγω της ελεγχόμενης διόγκωσης που προσφέρει το ειδικό λεπτότερο καλαμάκι. Είναι κατάλληλος για πλήρωση κενών, ρωγμών και οπών, έχει εξαιρετική πρόσφυση σε όλα τα υποστρώματα και είναι ανθεκτικός στο νερό και τη γήρανση. Επιπλέον έχει ελεύθερη διόγκωση από 40 έως 5 λίτρα ανά φιάλη, ενώ δεν συρρικνώνεται μετά τη σκλήρυνση.



NEW ARRIVAL

ΑΦΡΟΣ ΠΟΛΥΟΥΡΕΘΑΝΗΣ ΕΛΕΓΧΟΜΕΝΗΣ ΔΙΟΓΚΩΣΗΣ LASTOFOAM 2 IN 1

Barcode	Volume	Unit
15662	750ml, Χειρός & Πιστολιού	12



• Διαλυτικό σε μορφή σπρέυ για τον καθαρισμό πιστολιών αφρού πολυουρεθάνης καθώς και για την απομάκρυνση φρέσκου αφρού που δεν έχει σκληρύνει από επιφάνειες ή εργαλεία. Διάρκεια ζωής: 36 μήνες τουλάχιστον από την ημερομηνία παραγωγής στην κλειστή αρχική συσκευασία μεταξύ +5°C και +25°C αποθηκευμένο σε στεγνό μέρος.

ΚΑΘΑΡΙΣΤΙΚΟ ΓΙΑ ΑΦΡΟ ΠΙΣΤΟΛΙΟΥ

07995	500ml	12



• Ακετοξική σιλικόνη υψηλής μηχανικής αντοχής και εξαιρετικής συγκολλητικότητας σε μη πορώδη υποστρώματα. Επιδεικνύει ιδιαίτερη αντοχή στη γήρανση εφόσον διατηρεί τις ιδιότητές της για πάνω από 15 έτη ακόμη και σε δύσκολες εξωτερικές συνθήκες όπως έκθεση σε ηλιακή ακτινοβολία, βροχή, και παγετό. Συνιστάται σε εφαρμογές υψηλών απαιτήσεων (βιομηχανικές ή τεχνολογικές), όπως ενυδρεία, ηλιακούς θερμοσίφωνες, βιτρίνες καταστημάτων, υαλοκατασκευές, σκάφη αναψυχής, κ.α. Δεν βάφεται. Διάρκεια ζωής: 12 μήνες τουλάχιστον από την ημερομηνία παραγωγής στην κλειστή αρχική συσκευασία μεταξύ +5°C και +25°C αποθηκευμένο σε στεγνό μέρος.

ΣΙΛΙΚΟΝΗ S100

07265	280ml - διαφανή	24



• Καθαριστικό ζελέ υπολειμμάτων στεγνωμένης σιλικόνης, σε παστώδη υφή και κόκκινη απόχρωση. Διαλύει τη στερεοποιημένη σιλικόνη χωρίς να αφήνει υπόλειμμα. Είναι κατάλληλο για οριζόντια και κάθετη χρήση σε επιφάνειες όπως γυαλί, μέταλλο, κεραμικά, πορσελάνη αφού προηγηθεί δοκιμή. Ξεπλένεται με νερό.

ΠΑΣΤΑ ΚΑΘΑΡΙΣΜΟΥ ΣΙΛΙΚΟΝΗΣ SILICONE REMOVER SR 52

14026	80ml	12



• Ακετοξική σιλικόνη ανθεκτική στην εμφάνιση μούχλας για τη σφράγιση αρμών μεταξύ γυαλιού, αλουμινίου, πορσελάνης, κεραμικών. Ανθεκτική στο νερό, την υγρασία και τα απορρυπαντικά. Μετά το πολυμερισμό της παρουσιάζει περιορισμένη συρρίκνωση. Είναι ιδιαίτερα κατάλληλη για μπάνια και κουζίνες (μπανιέρες, νιπτήρες, νεροχύτες, πλακάκια, κ.α), νοσοκομεία, εργαστήρια. Το μυκητοκτόνο που περιέχει εμποδίζει την εμφάνιση μυκήτων στην επιφάνεια του σφραγιστικού. Δεν συνιστάται η εφαρμογή του σε ενυδρεία. Δεν βάφεται. Διάρκεια ζωής: 12 μήνες τουλάχιστον από την ημερομηνία παραγωγής στην κλειστή αρχική συσκευασία μεταξύ +5°C και +25°C αποθηκευμένο σε στεγνό μέρος.

ΣΙΛΙΚΟΝΗ S200

08095	280ml - διάφανη	25
08096	280ml - λευκή	25
09639	600ml - διάφανη	15
09640	600ml - λευκή	15



GET IT NOW

• Ακετοξική σιλικόνη γενικής χρήσης ανθεκτική στην εμφάνιση μούχλας. Έχει πολύ καλή πρόσφυση, χωρίς αστάρι, σε πληθώρα υποστρωμάτων. Παρουσιάζει υψηλή ελαστικότητα καθώς και υψηλή αντοχή στις καιρικές συνθήκες. Κατάλληλη για σφράγιση συναρμογών σε μη πορώδη υλικά, όπως γυαλί, αλουμίνιο, πορσελάνινα πλακάκια, κεραμικά, κ.α.

Έχει ευρεία εφαρμογή σε συναρμογές γύρω από κουφώματα αλουμινίου, ειδών υγιεινής και πάγκων κουζίνας. Δεν βάφεται.

Διάρκεια ζωής: 12 μήνες τουλάχιστον από την ημερομηνία παραγωγής στην κλειστή αρχική συσκευασία μεταξύ +5°C και +25°C αποθηκευμένο σε στεγνό μέρος.



ΣΙΛΙΚΟΝΗ S400

Barcode	Icon	Volume & Color	Quantity
06609		80ml - διάφανη	25
06610		80ml - λευκή	25
13573		80ml - μαύρη	25
07359		280ml - διάφανη	25
13627		280ml - λευκή	25
09054		280ml - γκρι	12
09055		280ml - καφέ	12
07360		280ml - μαύρη	12



NEW ARRIVAL

Αρμόκολλα υψηλής σκληρότητας με βάση ειδικό τύπο σιλικόνης. Έχει καλή πρόσφυση σε βαμμένο αλουμίνιο, δεν λεκιάζει και δεν κιτρινίζει ενώ μπορεί να χρησιμοποιηθεί μετά από αρκετό καιρό ακόμη και εάν η συσκευασία έχει ανοιχθεί, χωρίς να έχει χάσει τις ιδιότητές της.

Η S-800 είναι ιδανική για τη σφράγιση των τριχοειδών αρμών που δημιουργούνται στα φάλτσα των κουφωμάτων αλουμινίου. Δεν βάφεται.

Διάρκεια ζωής: 12 μήνες τουλάχιστον από την ημερομηνία παραγωγής στην κλειστή αρχική συσκευασία μεταξύ +5°C και +25°C αποθηκευμένο σε στεγνό μέρος.



ΣΙΛΙΚΟΝΗ S800 (ΑΡΜΟΚΟΛΛΑ)

Barcode	Icon	Volume & Color	Quantity
09997		280ml - λευκή	25
14990		280ml - μαύρη	12



• Ουδέτερη σιλικόνη που δεν συρρικνώνεται με άριστη πρόσφυση σε όλα τα υποστρώματα, πορώδη και μη πορώδη. Παρουσιάζει εξαιρετική αντοχή στις καιρικές συνθήκες (ακτινοβολία UV, βροχή, παγετός). Είναι κατάλληλη για σφράγιση και συγκόλληση κατασκευών από γυαλί, πλακίδια, κεραμικά, υαλότουβλα, πλαστικά (PVC, εποξειδικά, πολυεστέρες, πολυακρυλικά, πολυκαρβονικά και φορμάικα), βαμμένο ή περασμένο με βερνίκι ξύλο, κ.α. Παρουσιάζει άριστη πρόσφυση σε μεταλλικές επιφάνειες χωρίς να τις διαβρώνει ή να τις οξειδώνει όπως γαλβανιζέ λαμαρίνες, ανοξείδωτα μεταλλα, ψευδάργυρο, χαλκό, αλουμίνια βαμμένα με ηλεκτροστατική βαφή ή άβαφα, κ.α. Η S-900 είναι ιδιαίτερα κατάλληλη για σφράγιση στην εξωτερική πλευρά των κουφωμάτων (αλουμινίου ή PVC) ανάμεσα στο προφίλ και το μάρμαρο ή τον τοίχο. Δεν βάφεται. Διάρκεια ζωής: 12 μήνες τουλάχιστον από την ημερομηνία παραγωγής στην κλειστή αρχική συσκευασία μεταξύ +5°C και +25°C αποθηκευμένο σε στεγνό μέρος.



ΣΙΛΙΚΟΝΗ S900

Barcode	Icon	Volume & Color	Quantity
10258		280ml - διάφανη	25
14024		280ml - λευκή	25
10062		280ml - ασημί RAL 9006	12
11306		280ml - γκρι RAL 7005	12
11305		280ml - γκρι RAL 7045	12
05142		280ml - δρυς	12
05575		280ml - δρυς σκούρο	12
06122		280ml - καφέ RAL 8014	12
05141		280ml - μπλε RAL 1015	12
07765		280ml - πράσινη RAL 6009	12
14580		280ml - μπλε RAL 5010 (ουδέτερη)	12
14951		600ml - διάφανη (ουδέτερη)	15



05937



05936



• Η ISOFIX SILICONE είναι οικονομική αντιμικροβιακή ακετοξική σιλικόνη με πολύ καλή πρόσφυση κατάλληλη για σφράγιση συναρμογών σε μη πορώδη υλικά, όπως γυαλί, αλουμίνιο, πορσελάνινα πλακάκια, κεραμικά, κ.α.

Έχει ευρεία εφαρμογή σε συναρμογές γύρω από κουφώματα αλουμινίου, ειδών υγιεινής και πάγκων κουζίνας.

Διάρκεια ζωής: 12 μήνες τουλάχιστον από την ημερομηνία παραγωγής στην κλειστή αρχική συσκευασία μεταξύ +5°C και +25°C αποθηκευμένο σε στεγνό μέρος.

ΣΙΛΙΚΟΝΗ ISOFIX

Barcode	Volume	Color	Quantity
05937	260ml	διάφανη	25
05936	260ml	λευκή	25

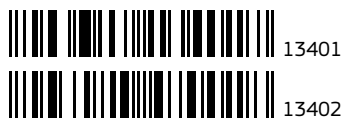
HOT
SELLER

13401



13402



• Η ISOFIX NEUTRAL είναι ουδέτερη αντιμικροβιακή σιλικόνη που πολυμερίζεται με την υγρασία και δημιουργεί μία ισχυρή, ελαστική μάζα. Είναι ιδανική για σφράγιση αρμών σε κουζίνες (νεροχύτες, περβάγια, πάγκους), μπάνια (νιπτήρες, μπανιέρες, πλακάκια, ντουζιέρες κ.α). Εμποδίζει την ανάπτυξη μύκητα (μαύρες κηλίδες) στην επιφάνεια του. Ενδείκνυται ειδικά για εφαρμογές σε πλαστικές μπανιέρες και ντουζιέρες όπου οι κοινές σιλικόνες αποτυγχάνουν. Είναι επίσης ιδανική για σφράγιση αρμών σε γυάλινες κατασκευές, όλους τους τύπους κουφωμάτων, σωλήνες ύδρευσης, μεταλλικές κατασκευές κ.α. Διάρκεια ζωής: 12 μήνες τουλάχιστον από την ημερομηνία παραγωγής στην κλειστή αρχική συσκευασία μεταξύ +5°C και +25°C αποθηκευμένο σε στεγνό μέρος

ΣΙΛΙΚΟΝΗ ISOFIX NEUTRAL

Barcode	Volume	Color	Quantity
13401	280ml	διάφανη	12
13402	280ml	λευκή	12



13407



• Οξίνη σιλικόνη ανθεκτική στην ανάπτυξη μούχλας, με εξαιρετική αντοχή στην ακτινοβολία UV και στις καιρικές συνθήκες. Στεγνώνει με την υγρασία του ατμοσφαιρικού αέρα και μετατρέπεται σε μία μόνιμη ελαστική μάζα. Είναι κατάλληλη για σφράγιση αρμών σε είδη υγιεινής και κουζίνας (νιπτήρες, μπανιέρες, λεκάνες, νεροχύτες, πάγκοι κουζίνας, πλακάκια κ.α.) καθώς και για σφραγίσεις αρμών σε υαλοκατασκευές. Διάρκεια ζωής: 12 μήνες τουλάχιστον από την ημερομηνία παραγωγής στην κλειστή αρχική συσκευασία μεταξύ +5°C και +25°C αποθηκευμένο σε στεγνό μέρος.

ΣΙΛΙΚΟΝΗ ΟΞΙΝΗ FLEXSiL 300

Barcode	Volume	Color	Quantity
13407	280ml	διάφανη	25



• Καθρεπτόκολλα ενός συστατικού με εξαιρετικές συγκολλητικές ικανότητες σε όλα τα υποστρώματα, όπως ξύλο, νοβοπάν, μπετόν, σοβά, τοίχους βαμμένους με πλαστικά χρώματα ή ριπολίνη. Είναι άοσμη και δεν ενοχλεί καθόλου το δέρμα και τα μάτια. Προσφέρει εξασφαλισμένη συγκόλληση ενώ παράλληλα δεν καταστρέφει την επαργύρωση του καθρέπτη. Διάρκεια ζωής: 12 μήνες τουλάχιστον από την ημερομηνία παραγωγής στην κλειστή αρχική συσκευασία μεταξύ +5°C και +25°C αποθηκευμένο σε στεγνό μέρος.



ΣΙΛΙΚΟΝΗ ΓΙΑ ΚΑΘΡΕΠΤΗ S-MIRROR

08220	280ml - λευκή	25



• Όξινη σιλικόνη υψηλής ποιότητας με ενσωματωμένη τεχνολογία αντιβακτηριδιακής προστασίας FUNGIBAN® που προσφέρει ενεργή πρόληψη κατά της ανάπτυξης μυκήτων σε περιοχές εκτεθειμένες σε υγρασία. Είναι κατάλληλη για σφράγιση αρμών σε κατασκευές από γυαλί, αλουμίνιο, πορσελάνη (πλακίδια, είδη υγιεινής) και μη πορώδη κεραμικά. Είναι ιδιαίτερα κατάλληλη για εφαρμογές σε μπάνια και κουζίνες (μπαγιέρες, νιπτήρες, νεροχύτες, πλακίδια, κ.λπ), νοσοκομεία, εργαστήρια και γενικά σε οποιοδήποτε χώρο υπάρχει αυξημένη ανάγκη τήρησης κανόνων υγιεινής. Επίσης είναι ιδανική για κουφώματα ή κάσες με αυξημένη υγρασία λόγω συμπυκνώσεων υδρατμών. Με φυσιολογικές συνθήκες καθαρισμού παραμένει αναλλοίωτη χρωματικά (δεν μαυρίζει) ακόμη και μετά από 10 έτη. Δεν συνιστάται η εφαρμογή του σε ενυδρεία. Δεν βλάφεται. Διάρκεια ζωής: 12 μήνες τουλάχιστον από την ημερομηνία παραγωγής στην κλειστή αρχική συσκευασία μεταξύ +5°C και +25°C αποθηκευμένο σε στεγνό μέρος.



ΣΙΛΙΚΟΝΗ SUPERWHITE 10 FUNGIBAN

09067	280ml - διάφανη	12
10242	280ml - λευκή	12



08094



13552



05778



13553



• Η S-HI TEMP είναι επαγγελματική σιλικόνη υψηλών θερμοκρασιών από -40°C έως +260°C, ενώ για περιορισμένο χρονικό διάστημα αντέχει έως και τους +300°C. Δεν σκάει και δεν συρρικνώνεται. Αντέχει σε λάδια, γράσο, νερό, αντιψυκτικό και βαλβολίνες. Μετά το πολυμερισμό παραμένει ελαστική. Είναι ιδανική σαν υγρή φλάντζα σε μηχανές αυτοκινήτων, αντλιών, καυστήρων, καπάκια βαλβίδων, σωλήνες εξάτμισης ή εξαερισμού. Διάρκεια ζωής: 12 μήνες τουλάχιστον από την ημερομηνία παραγωγής στην κλειστή αρχική συσκευασία μεταξύ +5°C και +25°C αποθηκευμένο σε στεγνό μέρος.



ΣΙΛΙΚΟΝΗ S-HI-TEMP

08094	80ml - κόκκινη	12
13552	80ml - μαύρη	12
05778	280ml - κόκκινη	12
13553	280ml - μαύρη	12



• Σφραγιστικό ενός συστατικού κατάλληλο για αρμούς που βρίσκονται εκτεθειμένοι σε πολύ υψηλές θερμοκρασίες (έως 1200°C). Στεγνώνει με φυσική εξάτμιση. Είναι ιδιαίτερα κατάλληλο για σφραγίσεις σε τζακία, φούρνους, λέβητες, εστίες, καμινάδες και σωληνώσεις ατμού. Παρουσιάζει άριστη πρόσφυση σε μεγάλη ποικιλία υποστρωμάτων όπως πυρότουβλα, μπετόν, μεταλλικές επιφάνειες, φυσικές πέτρες, κ.α. Το FIRESEAL W παρουσιάζει περιορισμένη αντοχή στο νερό. Βάφεται. Διάρκεια ζωής: 12 μήνες τουλάχιστον από την ημερομηνία παραγωγής στην κλειστή αρχική συσκευασία μεταξύ +5°C και +25°C αποθηκευμένο σε στεγνό μέρος.



ΣΦΡΑΓΙΣΤΙΚΟ ΤΖΑΚΙΩΝ FIRESEAL W (1200°C)

09070	280ml - μαύρη	25



ΣΦΡΑΓΙΣΤΙΚΑ

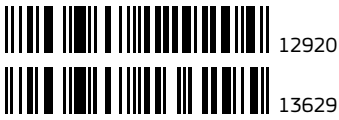

• Ελαστομερές σφραγιστικό υλικό με εξαιρετική πρόσφυση σε μεγάλη ποικιλία υποστρωμάτων. Το ELASTOTAN μπορεί να χρησιμοποιηθεί για σφράγιση επιφανειών από γυαλί, μέταλλο, απλό και βαμμένο ξύλο, PVC, πολυκαρβονικό, πολυμεθακρυλικό, τσιμέντο, γρανίτη, μάρμαρο κ.α. Είναι ιδιαίτερα κατάλληλο για σφραγίσεις σε πληθώρα κατασκευαστικών εφαρμογών όπως αρμοί διαστολής σκυροδέματος, αρμοί σε υαλοπετάσματα, αρμοί κουφωμάτων παραθύρων και πορτών, αρμοί σε υαλοκατασκευές, αρμοί σε οροφές και καμινάδες, αρμοί υδρορροών και αεραγωγών, κ.α. Διάρκεια ζωής: 12 μήνες τουλάχιστον από την ημερομηνία παραγωγής στην κλειστή αρχική συσκευασία μεταξύ +5°C και +25°C αποθηκευμένο σε στεγνό μέρος.

ΣΦΡΑΓΙΣΤΙΚΟ ΑΡΜΩΝ ELASTOTAN

Barcode	Icon	Volume	Color	Quantity
12920		280ml	Λευκό	12
13629		280ml	γκρι	12



• Ελαστομερές σφραγιστικό αρμών ενός συστατικού που πολυμερίζεται με την ατμοσφαιρική υγρασία. Είναι ιδιαίτερα κατάλληλο σε προσόψεις κτιρίων από φυσικές πέτρες όπως μάρμαρο, γρανίτη, κ.α. Επίσης μπορεί να χρησιμοποιηθεί για σφράγιση αρμών μεταξύ ομοειδών και ετεροειδών υλικών σε όλων των ειδών τις κατασκευές, όπως αρμούς σκυροδέματος (συστολής - διαστολής, διακοπής), υποστρώματα από σοβά, γυαλί, αλουμίνιο, ξύλο, πολυκαρβονικό, πέτρα, πλαστικό, αμιαντοτσιμέντο, τοποθέτηση σωλήνων από μέταλλο ή PVC, τοποθέτηση μεμβρανών από PVC σε μόνωση ταρατσών, συναρμογές κουφωμάτων, κ.α. Διάρκεια ζωής: 12 μήνες τουλάχιστον από την ημερομηνία παραγωγής στην κλειστή αρχική συσκευασία μεταξύ +5°C και +25°C αποθηκευμένο σε στεγνό μέρος.

ΣΦΡΑΓΙΣΤΙΚΟ ΑΡΜΩΝ ELASTOTAN S

Barcode	Icon	Volume	Color	Quantity
13630		280ml	Λευκό	12



GET IT NOW

• Ελαστομερές σφραγιστικό πολυουρεθανικής βάσης με εξαιρετική πρόσφυση σε μεγάλη ποικιλία υποστρωμάτων. Παρουσιάζει υψηλή ελαστικότητα σε μεγάλο θερμοκρασιακό εύρος, είναι κατάλληλο για αρμούς μεγάλης κινητικότητας ενώ βάφεται με τα συνήθη οικοδομικά χρώματα. Συνιστάται για σφραγίσεις και συγκολλήσεις μεταξύ ομοειδών και ετεροειδών υλικών σε κλασικά κτιριακά και τεχνικά έργα, προκατασκευασμένα, βιομηχανικές εφαρμογές, εσωτερική διακόσμηση κλπ. Έχει πρόσφυση στα περισσότερα υποστρώματα των κτιριακών κατασκευών: κεραμικά, τσιμέντο, γυαλί, ξύλο, γαλβανιζέ λαμαρίνα κλπ. Διάρκεια ζωής: 12 μήνες τουλάχιστον από την ημερομηνία παραγωγής στην κλειστή αρχική συσκευασία μεταξύ +5°C και +25°C αποθηκευμένο σε στεγνό μέρος.

ΣΦΡΑΓΙΣΤΙΚΟ ΠΟΛΥΟΥΡΕΘΑΝΗΣ ELASTOSEAL PU 25 LM

Barcode	Icon	Volume	Color	Quantity
09069		310ml	Λευκό	25
13949		310ml	γκρι	25
14840		310ml	κεραμιδί	25
14843		310ml	μπεζ	25
09134		600ml	Λευκό	15
09133		600ml	γκρι	15
14863		600ml	κεραμιδί	15



• Το ELASTOSEAL PU 50 FC είναι ελαστομερές σφραγιστικό και συγκολλητικό υλικό πολυουρεθανικής βάσης με υψηλή μηχανική αντοχή και μεγάλη ταχύτητα πολυμερισμού. Συνιστάται για σφραγίσεις και συγκολλήσεις μεταξύ ομοειδών και ετεροειδών υλικών σε κτιριακές εφαρμογές, σε βιομηχανικές εφαρμογές, στην κατασκευή κουφωμάτων αλουμινίου, σε ανελκυστήρες, κ.α. Είναι ιδιαίτερα κατάλληλο και για εφαρμογές στην φανοποιεία και σε σκάφη αναψυχής. Έχει πρόσφυση σε μεγάλη ποικιλία υποστρωμάτων όπως μπετόν, γυαλί, ξύλο, γαλβανιζέ λαμαρίνα, αλουμίνιο, κ.α. Διάρκεια ζωής: 9 μήνες τουλάχιστον από την ημερομηνία παραγωγής στην κλειστή αρχική συσκευασία μεταξύ +5°C και +25°C αποθηκευμένο σε στεγνό μέρος.

ΣΦΡΑΓΙΣΤΙΚΟ ΠΟΛΥΟΥΡΕΘΑΝΗΣ ELASTOSEAL PU 50 FC

Barcode	Icon	Volume/Color	Icon
13083		310ml - λευκό	25
13355		310ml - γκρι	25
13084		310ml - μαύρο	25
13283		600ml - λευκό	15
14014		600ml - γκρι	15
13090		600ml - μαύρο	15



• Πρόκειται για ένα ελαστομερές σφραγιστικό ενός συστατικού κατάλληλο για σφράγιση αρμών σε δάπεδα από ξύλο, laminate και μορισοσανίδα. Είναι ιδιαίτερα κατάλληλο για τους αρμούς στα τελειώματα του παρκέ, στις ενώσεις του με μάρμαρα ή πλακάκια, στα σοβατεπιά, στις συναρμογές με τις σωληνώσεις του καλοριφέρ, κ.α. Είναι επίσης κατάλληλο για σφραγίσεις αρμών σε πόρτες και παράθυρα από ξύλο, αλουμίνιο ή PVC. Γενικά είναι κατάλληλο για αρμούς μέτριας κινητικότητας (μέχρι 8%).

Δεν είναι κατάλληλο για αρμούς με μόνιμη εμπάττιση στο νερό.
Διάρκεια ζωής: 18 μήνες τουλάχιστον από την ημερομηνία παραγωγής στην κλειστή αρχική συσκευασία μεταξύ +5°C και +25°C αποθηκευμένο σε στεγνό μέρος.

ΣΦΡΑΓΙΣΤΙΚΟ ΞΥΛΟΥ PARQUET FLOORING ACRYSEAL

Barcode	Icon	Volume/Color	Icon
13444		280ml - δρυς	12
13445		280ml - καρυδιά	12
13446		280ml - κερασιά	12
13447		280ml - μαόνι	12
13448		280ml - οξιδιά	12
13449		280ml - σφένδαμος	12



• Ισχυρό σφραγιστικό-συγκολλητικό με βάση υβριδικές ρητίνες που πολυμερίζεται με την υγρασία και σχηματίζει μία ισχυρή και ελαστική μάζα.

Φιλικό προς το χρήστη ουδέτερο και άοσμο. Δεν συρρικνώνεται και παραμένει ελαστικό σε θερμοκρασίες από -40°C έως +100°C. Είναι ιδανικό για στερέωση, σφράγιση και κόλληση σε πάρα πολλά υποστρώματα.

Ως υπερδιάφανο συνιστάται για γυάλινες κατασκευές όπως διαχωριστικά, καμπίνες ντους, βιτρίνες, πλαίσια κ.α.

Διάρκεια ζωής: 12 μήνες τουλάχιστον από την ημερομηνία παραγωγής στην κλειστή αρχική συσκευασία μεταξύ +5°C και +25°C αποθηκευμένο σε στεγνό μέρος.



ΣΦΡΑΓΙΣΤΙΚΟ - ΣΥΓΚΟΛΛΗΤΙΚΟ ISOFIX HYBRID CLEAR



13406

280ml - διάφανο

12



• Ισχυρό σφραγιστικό-συγκολλητικό με βάση υβριδικές ρητίνες που πολυμερίζεται με την υγρασία και σχηματίζει μία ισχυρή και ελαστική μάζα.

Φιλικό προς το χρήστη ουδέτερο και άοσμο. Δεν συρρικνώνεται και παραμένει ελαστικό σε θερμοκρασίες από -40°C έως +100°C.

Αντιμολυκτικό, δεν διαβρώνει τα μέταλλα.

Προϊόν προηγμένης τεχνολογίας (all in one), υποκαθιστά τις σιλικόνες, ακρυλικά, πολυουρεθανικά σφραγιστικά, δομικές κόλλες, ξυλόκολλες, κόλλες στερέωσης κ.α. Είναι κατάλληλο για σφράγιση αρμών σε όλους τους τύπους κουφωμάτων, οροφές, δάπεδα, σωλήνες ύδρευσης, συστήματα εξαερισμού κ.ο.κ. Λόγω της μεγάλης μηχανικής αντοχής και της μόνιμης ελαστικότητας του είναι ιδανικό για συγκολλήσεις μεταξύ ετεροειδών υλικών όπου αναπτύσσονται μεγάλα μηχανικά φορτία. Ενδεικτικά προτείνεται για κόλληση καθρεπτών, πλακιδίων, αξεσουάρ μπάνιου, νιπτήρων, γυψοσανίδων, διακοσμητικών υλικών, μεταλλικών πλαισίων, περβαζίων κ.α. Διάρκεια ζωής: 12 μήνες τουλάχιστον από την ημερομηνία παραγωγής στην κλειστή αρχική συσκευασία μεταξύ +5°C και +25°C αποθηκευμένο σε στεγνό μέρος.



ΣΦΡΑΓΙΣΤΙΚΟ - ΣΥΓΚΟΛΛΗΤΙΚΟ ISOFIX HYBRID



13405

280ml - λευκό

12



10249



09728



10581



• Το ELASTOBOND είναι ελαστομερές σφραγιστικό και συγκολλητικό με βάση υβριδικές ρητίνες και προσφέρει ταχύτατη συγκόλληση. Είναι κατάλληλο για σφραγίσεις και ελαστικές συγκολλήσεις σε όλα τα υποστρώματα όπως μεταλλικές επιφάνειες, σκυρόδεμα, πλαστικά, βαμμένο αλουμίνιο, γυαλί, μάρμαρο. Ενδείκνυται για συγκόλληση καθρεπτών (δεν καταστρέφει την επαγωγή του καθρέπτη) καθώς και για συγκολλήσεις στη διαδικασία παραγωγής πάνελ, πορτών ασφαλείας, κ.λ.π.

Διάρκεια ζωής: 12 μήνες τουλάχιστον από την ημερομηνία παραγωγής στην κλειστή αρχική συσκευασία μεταξύ +5°C και +25°C αποθηκευμένο σε στεγνό μέρος.

ΣΦΡΑΓΙΣΤΙΚΟ ΣΥΓΚΟΛΛΗΤΙΚΟ ELASTOBOND



10249

280ml - λευκό

12

09728

280ml - υπερδιάφανο

12

10581

280ml - γκρι

12



• Χημικό αγκύριο, πολυεστερικής βάσης, χωρίς στυρένιο, για χαμηλά - μεσαία φορτία. Είναι κατάλληλο για αγκυρώσεις ντιζών και βιδών σε συμπαγείς ή κούφιες επιφάνειες από σκυρόδεμα, τούβλα και πέτρες. Είναι εύχρηστο και εφαρμόζεται μόνο σε στεγνές επιφάνειες. Δεν χρειάζεται προανάμιξη των δύο συστατικών. Είναι θιξοτροπικό. Δεν κρεμάει. Προσφέρει υψηλή πρόσφυση στα εφαρμοζόμενα υλικά και διεισδυτικότητα σε τρύπες και κενά. Διάρκεια ζωής: 12 μήνες τουλάχιστον από την ημερομηνία παραγωγής στην κλειστή αρχική συσκευασία μεταξύ +5°C και +25°C αποθηκευμένο σε στεγνό μέρος.

ΧΗΜΙΚΟ ΒΥΣΜΑ ANCHOR FIX-PE 320

14126	300ml	15



NEW ARRIVAL

Ελαστομερές συγκολλητικό με πολύ υψηλή άμεση συγκράτηση. Έχει εξαιρετική πρόσφυση στα περισσότερα υποστρώματα, πορώδη και μη πορώδη, ακόμη και σε υγρά χωρίς τη χρήση ασαριού. Παραμένει μόνιμα ελαστικό και απορροφά τους κραδασμούς ενώ έχει εξαιρετική αντοχή στο νερό ακόμη και το θαλασσινό. Παρέχει αντοχή στην ηλιακή ακτινοβολία και στις θερμοκρασιακές μεταβολές (-40°C και +100°C). Ιδανικό για στερέωση αντικειμένων σε τοίχους. 25ml προϊόντος μπορούν να συγκρατήσουν ως και 20kg σε κατακόρυφες επιφάνειες. Καταργεί βίδες και καρφιά, χωρίς να απαιτείται κάποια προσωρινή, συμπληρωματική συγκράτηση. Είναι επίσης κατάλληλο για εφαρμογές με δυναμικά φορτία (αυτοκίνητα, μηχανήματα, σκάφη αναψυχής κ.α.). Κολλά τέλεια σε επιφάνειες όπως γυαλί, ξύλο, βαμμένο ή μη αλουμίνιο, καθρέπτες, μπετό, PVC, πολυκαρβονικά, ABS κ.α. Ταυτόχρονα γεμίζει και σφραγίζει αρμούς, ρωγμές και κενά. Διάρκεια ζωής: 18 μήνες από την ημερομηνία παραγωγής στην κλειστή αρχική συσκευασία μεταξύ +5°C και +25°C, αποθηκευμένο σε στεγνό μέρος.

ΣΦΡΑΓΙΣΤΙΚΟ-ΣΥΓΚΟΛΛΗΤΙΚΟ ELASTOBOND HIGH TACK

14994	280ml - Λευκό	12Δ



09837



09998



GET IT NOW

• Ισχυρό συγκολλητικό ενός συστατικού με βάση τη πολυουρεθάνη κατάλληλο για συγκολλήσεις παρμπρίζ. Συνιστάται για ελαστικές συγκολλήσεις μεταξύ ομοειδών και ετεροειδών υλικών σε βιομηχανικές και ναυπηγικές εφαρμογές. Είναι ιδιαίτερα κατάλληλο για συγκολλήσεις παρμπρίζ σε επιβατικά οχήματα. Γενικώς συνιστάται για όλες τις εφαρμογές όπου απαιτείται μία ισχυρή ελαστική - δομική συγκόλληση μεταξύ ετεροειδών στοιχείων όπως μεταλλικά φύλλα, fiber-glass, κ.α., τα οποία υφίστανται υψηλό μηχανικό και θερμικό στρες. Διάρκεια ζωής: 9 μήνες τουλάχιστον από την ημερομηνία παραγωγής στην κλειστή αρχική συσκευασία μεταξύ +5°C και +25°C αποθηκευμένο σε στεγνό μέρος. Το WINDSHIELD BLACK PRIMER είναι αστάρι κατάλληλο για χρήση πριν από την τοποθέτηση της παρμπρίζόκλας πολυουρεθάνης σε όλες τις εφαρμογές τοποθέτησης κολλητών παρμπρίζ. Διάρκεια ζωής: 12 μήνες τουλάχιστον από την ημερομηνία παραγωγής στην κλειστή αρχική συσκευασία μεταξύ +5°C και +25°C αποθηκευμένο σε στεγνό μέρος.

ΠΑΡΜΠΡΙΖΟΚΟΛΛΑ PU 230 WINDSHIELD

09837	310ml	12
09998	50ml - primer	1



• Ισχυρό συγκολλητικό ενός συστατικού που αναπτύσσει τις συγκολλητικές και μηχανικές του ιδιότητες σε επαφή με την υγρασία του ατμοσφαιρικού αέρα. Συγκολλά όλα τα είδη των υλικών (αλουμίνιο, ξύλο, σκυρόδεμα, σίδηρο κλπ.), δεν περιέχει διαλύτες και δεν επηρεάζεται από το νερό και την υγρασία. Είναι ιδιαίτερα κατάλληλο για τις εσωτερικές συγκολλήσεις προφίλ αλουμινίου (κόλλα για γωνιάστρα), για όλες τις ξυλοκατασκευές, για υποκατάσταση βυσμάτων, για στερέωση μεταλλικών ράβδων και οπλισμού σε σκυρόδεμα και σε ένα πλήθος εφαρμογών. Η μάζα του δεν συρρικνώνεται, αντίθετα διογκώνεται ελαφρά και έτσι μπορεί να χρησιμοποιηθεί για την πλήρωση κενών και οπών σε σκυρόδεμα.

Διάρκεια ζωής: 12 μήνες τουλάχιστον από την ημερομηνία παραγωγής στην κλειστή αρχική συσκευασία μεταξύ +5°C και +25°C αποθηκευμένο σε στεγνό μέρος.



ΚΟΛΛΑ ΠΟΛΥΟΥΡΕΘΑΝΗΣ LASTOSTICK

11307	280ml - κόλλα για γωνιάστρα	12



• Το Montage Stick είναι κόλλα μοντάζ ακρυλικής βάσης, χωρίς διαλύτες. Κολλά άριστα σε όλα τα υποστρώματα όπως ξύλο, πλαστικό, μάρμαρο, πλακάκι, γύψο, σοβά. Είναι ιδιαίτερα κατάλληλο για στερέωση και συγκόλληση διαφόρων διακοσμητικών αντικειμένων από γύψο, πλαστικών καναλιών, πάνελ, σε επενδύσεις φύλλων από αφρώδη πολυουρεθάνη, φελιζόλ και PVC. Διάρκεια ζωής: 12 μήνες τουλάχιστον από την ημερομηνία παραγωγής στην κλειστή αρχική συσκευασία μεταξύ +5°C και +25°C αποθηκευμένο σε στεγνό μέρος.



ΚΟΛΛΑ MONTAGE-STICK

09068	280ml - Λευκή	12



12433



08053



08052



• Το Montage-S είναι κόλλα μονταρίσματος ενός συστατικού με βάση το συνθετικό καουτσούκ σε διασπορά διαλύτου. Είναι κατάλληλο για ισχυρές συγκολλήσεις σε πληθώρα εφαρμογών όπως: κολλήσεις διακοσμητικών στοιχείων όπως γυψοσανίδες, κανάλια καλωδίων, μαρμάρων σε περβάζια παραθύρων, ξύλινα πλαίσια, κολλήσεις σε πάνελς (από ξύλο, μορισσανίδα, λαμινέ, πλαστικά, φελλό, κ.α.), συγκολλήσεις νεροχυτών και νιπτήρων σε μπάνια και κουζίνες, συγκολλήσεις κεραμικών πλακιδίων και μαρμάρων σε δάπεδο ή τοίχο, συγκολλήσεις μηριζοδιακοπών σε τοίχους, κ.α. Παρουσιάζει άριστη πρόσφυση σε μεγάλη ποικιλία υποστρωμάτων, τόσο πορώδη όσο και μη-πορώδη, χωρίς primer. Είναι κατάλληλο για τα συνήθη οικοδομικά υλικά, όπως αλουμίνιο, γυαλί, PVC, ξύλο, σκυρόδεμα, πλακάκια, μάρμαρο, τούβλο, κ.α. Διάρκεια ζωής: 12 μήνες τουλάχιστον από την ημερομηνία παραγωγής στην κλειστή αρχική συσκευασία μεταξύ +5°C και +25°C αποθηκευμένο σε στεγνό μέρος.

ΚΟΛΛΑ MONTAGE-S

12433	80ml - διάφανη	25
08052	280ml - διάφανη	12
08053	280ml - μπεζ	25



• Το epoxy fast είναι ένα ισχυρό εποξειδικό συγκολλητικό δύο συστατικών, γρήγορης σκλήρυνσης. Είναι ανθεκτικό στο νερό, στα αλκάλια και στα διαλύματα οξέων. Δεν αλλοιώνεται χρωματικά, δεν σπάει και δεν συρρικνώνεται ενώ μπορεί να βαφεί, να γυαλοχαρτιστεί και να τρυπηθεί. Είναι κατάλληλο για συγκολλήσεις μεγάλης ποικιλίας υλικών όπως κεραμικά, γυαλί, ξύλο, δέρμα, κάποια είδη πλαστικών, μέταλλο, μάρμαρο, πορσελάνη, κ.α. Δεν είναι κατάλληλο για εφαρμογή σε πολυαιθυλένιο, πολυπροπυλένιο, τεφλόν και σιλκόνη. Διάρκεια ζωής: 24 μήνες τουλάχιστον από την ημερομηνία παραγωγής στην κλειστή αρχική συσκευασία μεταξύ +5°C και +25°C αποθηκευμένο σε στεγνό μέρος.



ΚΟΛΛΑ ΕΠΟΞΙΚΗ 5ΜΙΝ 2 ΣΥΣΤΑΤΙΚΩΝ EPOXY FAST

13442	28ml - σωληνάριο	12



• Το epoxy plastic είναι ένα ισχυρό εποξειδικό συγκολλητικό δύο συστατικών, με βάση το methylmethacrylate. Είναι ανθεκτικό στο νερό, στα αλκάλια και στα διαλύματα οξέων. Δεν αλλοιώνεται χρωματικά, δεν σπάει και δεν συρρικνώνεται ενώ μπορεί να βαφεί, να γυαλοχαρτιστεί και να τρυπηθεί. Ιδιαίτερα κατάλληλο για έκθεση σε ακραίες καιρικές συνθήκες (ακτινοβολία UV, χαμηλές και υψηλές θερμοκρασίες). Για συγκολλήσεις μεγάλης ποικιλίας υλικών όπως ατσάλι, αλουμίνιο, ξύλο, πέτρα, πλακάκια, μπετόν, κεραμικά, κ.α. Κατάλληλο για τα περισσότερα σκληρά πλαστικά, όπως PVC, fiberglass, plexiglass, πολυκαρβονικά και πολλά άλλα. Δεν είναι κατάλληλο για εφαρμογή σε πολυαιθυλένιο, πολυπροπυλένιο, τεφλόν και σιλκόνη. Διάρκεια ζωής: 24 μήνες τουλάχιστον από την ημερομηνία παραγωγής στην κλειστή αρχική συσκευασία μεταξύ +5°C και +25°C αποθηκευμένο σε στεγνό μέρος.



ΚΟΛΛΑ ΕΠΟΞΙΚΗ 2 ΣΥΣΤΑΤΙΚΩΝ EPOXY PLASTIC

13891	28ml - σωληνάριο	12



Το epoxy metal είναι ένα ισχυρό εποξειδικό συγκολλητικό δύο συστατικών, γεμισμένο με ρινίσματα ανοξείδωτου μετάλλου. Διατίθεται σε εύχρηστη συσκευασία διπλής σύριγγας η οποία αδειάζει ίση ποσότητα από το κάθε συστατικό. Είναι ανθεκτικό στο νερό, στα αλκάλια και στα διαλύματα οξέων. Δεν αλλοιώνεται χρωματικά, δεν σπάει και δεν συρρικνώνεται τόσο κατά τη διάρκεια όσο και μετά τη σκλήρυνσή του. Μπορεί να βαφεί, να γυαλοχαρτιστεί και να τρυπηθεί. Είναι κατάλληλο για συγκολλήσεις μεγάλης ποικιλίας υλικών όπως ατσάλι, ανοξείδωτο ατσάλι, αλουμίνιο, μπρούτζο, γαλβανισμένη λαμαρίνα, χαλκό, ξύλο, πέτρα, κάποια είδη πλαστικών, κ.α. Δεν είναι κατάλληλο για εφαρμογή σε πολυαιθυλένιο, πολυπροπυλένιο, τεφλόν και σιλκόνη. Είναι ιδιαίτερα κατάλληλο για εφαρμογή σε υλικά τα οποία υποκεινται σε ακραίες συνθήκες, όπως υψηλές θερμοκρασίες, έντονες δονήσεις, θαλασινό νερό, κ.α. Διάρκεια ζωής: 24 μήνες από την ημερομηνία παραγωγής στην κλειστή αρχική συσκευασία μεταξύ +5°C και +25°C αποθηκευμένο σε στεγνό μέρος.



ΚΟΛΛΑ ΕΠΟΞΙΚΗ 5ΜΙΝ 2 ΣΥΣΤ EPOXY METAL ELASTOTET

14794	28ml - σύριγγα	12



• Κόλλα στιγμής κυανοακρυλικής βάσης για ευρεία γκάμα εφαρμογών. Κολλάει άμεσα και δυνατά με μία μόνο σταγόνα. Είναι κατάλληλη για βιομηχανικές εφαρμογές, για οικιακή χρήση, για μοντελισμό, κ.α. Παρουσιάζει ισχυρή πρόσφυση σε γυαλιά, μέταλλα, ξύλα, πλαστικά, κεραμικά, ελαστικά, δέρματα, κ.α. Είναι ιδιαίτερα κατάλληλη για κολλήσεις και ενώσεις των ελαστικών παρεμβυσμάτων στα κουφώματα αλουμινίου. Διάρκεια ζωής: 12 μήνες τουλάχιστον από την ημερομηνία παραγωγής στην κλειστή αρχική συσκευασία μεταξύ +5°C και +25°C αποθηκευμένο σε στεγνό μέρος.



ΚΟΛΛΑ ΣΤΙΓΜΗΣ ΓΕΝΙΚΗΣ ΧΡΗΣΗΣ QUICK GRAB

13332	20gr - φιαλίδιο	20

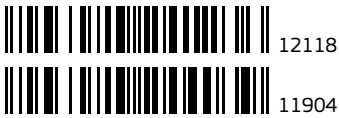

• Το PU MARINE ADHESIVE 105 είναι ιδιαίτερα κατάλληλο για ισχυρές συγκολλήσεις ανάμεσα σε ξύλα και άλλα ετεροειδή υλικά, σε πληθώρα βιομηχανικών και ναυτιλιακών εφαρμογών. Κολλά σε όλα τα υλικά όπως ξύλο, αλουμίνιο, σκυρόδεμα, πλακάκια κ.α.. Μετά τον πολυμερισμό, το προϊόν παραμένει εντελώς αδιάβροχο. Διάρκεια ζωής: 12 μήνες τουλάχιστον από την ημερομηνία παραγωγής στην κλειστή αρχική συσκευασία μεταξύ +5°C και +25°C αποθηκευμένο σε στεγνό μέρος.

ΣΥΓΚΟΛΛΗΤΙΚΟ ΠΟΛΥΟΥΡΕΘΑΝΙΚΟ PU MARINE

Barcode	Weight	Quantity
12118	200gr	6
11904	750gr	6



**HOT
SELLER**



• Οικονομικό σφραγιστικό ακρυλικό ενός συστατικού με βάση ακρυλικές ρητίνες, για εσωτερική και εξωτερική χρήση. Έχει καλή πρόσφυση στα περισσότερα υποστρώματα ενώ μπορεί να εφαρμοστεί ακόμη και σε υγρές επιφάνειες χωρίς τη χρήση ασαριού. Βάφεται μετά τη σκλήρυνσή του με τα συνήθη οικοδομικά χρώματα. Είναι ιδιαίτερα κατάλληλο για αρμούς υλικών με πορώδη επιφάνεια, όπως ανάμεσα σε παράθυρα και περβάζια, κουφώματα (πόρτες & παράθυρα), ρωγμές σε τοίχους, κ.τ.λ. Είναι κατάλληλο για αρμούς χωρίς ιδιαίτερη διαστασιακή μεταβολή (εώς 7%). Δεν είναι κατάλληλο για σφράγιση αρμών μόνιμα εμβαπτισμένων στο νερό (π.χ δεξαμενές). Διάρκεια ζωής: 18 μήνες τουλάχιστον από την ημερομηνία παραγωγής στην κλειστή αρχική συσκευασία μεταξύ +5°C και +25°C αποθηκευμένο σε στεγνό μέρος.

ΣΤΟΚΟΣ ΑΚΡΥΛΙΚΟΣ ISOFIX

Barcode	Weight	Quantity
05935	260ml - λευκός	25

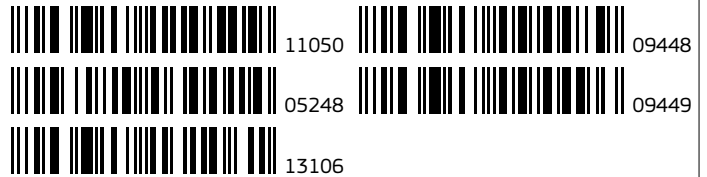

• Σφραγιστικό ακρυλικό ενός συστατικού με βάση ακρυλικές ρητίνες, για εσωτερική και εξωτερική χρήση. Έχει καλή πρόσφυση στα περισσότερα υποστρώματα ενώ μπορεί να εφαρμοστεί ακόμη και σε υγρές επιφάνειες χωρίς τη χρήση ασαριού. Βάφεται μετά τη σκλήρυνσή του με τα συνήθη οικοδομικά χρώματα. Είναι ιδιαίτερα κατάλληλο για αρμούς υλικών με πορώδη επιφάνεια, όπως ανάμεσα σε παράθυρα και περβάζια, κουφώματα (πόρτες & παράθυρα), ρωγμές σε τοίχους, κ.τ.λ. Είναι κατάλληλο για αρμούς χωρίς ιδιαίτερη διαστασιακή μεταβολή (εώς 7%). Δεν είναι κατάλληλο για σφράγιση αρμών μόνιμα εμβαπτισμένων στο νερό (π.χ δεξαμενές). Διάρκεια ζωής: 18 μήνες τουλάχιστον από την ημερομηνία παραγωγής στην κλειστή αρχική συσκευασία μεταξύ +5°C και +25°C αποθηκευμένο σε στεγνό μέρος.

ΣΤΟΚΟΣ ΑΚΡΥΛΙΚΟΣ ACRYLIC

Barcode	Weight	Quantity
11050	280ml - λευκός	25
05248	280ml - καφέ	25
13106	280ml - μαύρος	25
09448	400ml - λευκός	30
09449	600ml - λευκός	15

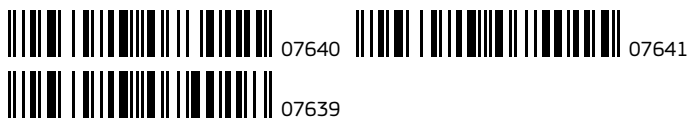

• Ακρυλικός στόκος οικοδομών για το στοκάρισμα και το σπατουλάρισμα σε όλα τα υποστρώματα. Πριν από το βάψιμο παράγεται υπό κενό (δεν περιέχει φυσαλίδες). Δουλεύεται γρήγορα, γεμίζει και στρώνει θαυμάσια, στεγνώνει γρήγορα χωρίς να σκάει και τρίβεται εύκολα προσφέροντας μία λεία και ανθεκτική επιφάνεια χωρίς ατέλειες. Δημιουργεί ένα μη απορροφητικό, υπέρλευκο υπόστρωμα, ιδανικό για βάψιμο. Χρησιμοποιείται για το σπατουλάρισμα επιφανειών (τοιχών, ξύλου, κτλ) και το στοκάρισμα πριν από το βάψιμο. Διάρκεια ζωής: 18 μήνες τουλάχιστον από την ημερομηνία παραγωγής στην κλειστή αρχική συσκευασία μεταξύ +5°C και +25°C αποθηκευμένο σε στεγνό μέρος.

ΣΤΟΚΟΣ ΣΠΑΤΟΥΛΑΣ ΑΚΡΥΛΙΚΟΣ ΛΕΥΚΟΣ LASTOSPAT

Barcode	Weight	Quantity
07640	400gr	48
07639	800gr	24
07641	5kgr	1



• Ελαφρύς ακρυλικός στόκος για στοκάρισμα σε όλα τα υποστρώματα πριν το βάψιμο. Γεμίζει και σπάζει με ένα πέρασμα χωρίς να συρρικνώνεται κατά το στέγνωμα και χωρίς να απαιτεί επαναστοκάρισμα. Δεν κρεμάει και στρώνει θαυμάσια, στεγνώνει γρήγορα χωρίς να σκάει ενώ ταυτόχρονα δημιουργεί ένα υπέρλευκο υπόστρωμα ιδανικό για βάψιμο. Διάρκεια ζωής: 18 μήνες από την ημερομηνία παραγωγής στην κλειστή αρχική συσκευασία μεταξύ +5°C και +25°C αποθηκευμένο σε στεγνό μέρος.

ΣΤΟΚΟΣ ΣΠΑΤΟΥΛΑΣ ΕΛΑΦΡΥΣ ΑΚΡΥΛΙΚΟΣ LASTOPLAST LIGHT WEIGHT

Barcode	Volume	Quantity
14489	250ml	48
14000	1lt	9
14001	3lt	1



• Ισχυρός εποξειδικός στόκος, κατάλληλος για γεμίματα σε ρωγμές και τρύπες σε δεξαμενές, βαρέλια, δοχεία, αντικείμενα οικιακής χρήσης, εργαλεία, αυτοκίνητα, σκάφη αναψυχής, κ.α. Παρουσιάζει εξαιρετική πρόσφυση σε μεγάλη ποικιλία υποστρωμάτων όπως μπετόν, μέταλλα, πέτρα, ξύλο και ορισμένα είδη πλαστικών, είναι ανθεκτικός σε υψηλές θερμοκρασίες έως +120°C. Είναι αδιάβροχος, κατάλληλος για εσωτερική, εξωτερική χρήση αλλά και για εφαρμογές κάτω από το νερό. Μπορεί να βαφεί, να γυαλοχαρτιστεί και να τριπηθεί. Διάρκεια ζωής: 12 μήνες από την ημερομηνία παραγωγής στην κλειστή αρχική συσκευασία μεταξύ +5°C και +25°C αποθηκευμένο σε στεγνό μέρος.

ΣΤΟΚΟΣ EPOXY REPAIR KIT

Barcode	Weight	Quantity
12030	57gr	12



• Υγρό μονωτικό επαλειπτικό με βάση ακρυλικές ρητίνες και ειδικά πρόσθετα. Χρησιμοποιείται για μόνωση ταρτασών. Εφαρμόζεται σε όλα τα υποστρώματα (σκυρόδεμα, πλάκες, αμιαντοσιμέντο, κ.α). Δεν είναι κατάλληλο για επιφάνειες μόνιμα εμβαπτισμένες σε νερό.

Διάρκεια ζωής: 12 μήνες τουλάχιστον από την ημερομηνία παραγωγής στην κλειστή αρχική συσκευασία μεταξύ +5°C και +25°C αποθηκευμένο σε στεγνό μέρος.

ΜΟΝΩΤΙΚΟ ΤΑΡΤΑΣΑΣ ΑΚΡΥΛΙΚΟ LASTOCRYL-R

Barcode	Weight	Quantity
12434	1kg	9
12435	5kg	1
12436	15kg	1



• Υγρό μονωτικό επαλειπτικό ενός συστατικού υβριδικής βάσης. Χρησιμοποιείται για μόνωση ταρτασών. Εφαρμόζεται σε όλα τα υποστρώματα (σκυρόδεμα, πλάκες, αμιαντοσιμέντο, κ.α). Δεν είναι κατάλληλο για επιφάνειες μόνιμα εμβαπτισμένες σε νερό.

Διάρκεια ζωής: 12 μήνες τουλάχιστον από την ημερομηνία παραγωγής στην κλειστή αρχική συσκευασία μεταξύ +5°C και +25°C αποθηκευμένο σε στεγνό μέρος.

ΜΟΝΩΤΙΚΟ ΤΑΡΤΑΣΑΣ ΥΒΡΙΔΙΚΗΣ ΒΑΣΗΣ LASTOFLEX-W

Barcode	Weight	Quantity
13996	3lt	1
13441	10lt	1



• Ελαστομερές επαλειπτικό ενός συστατικού με βάση τη πολυουρεθάνη, κατάλληλο για μόνιμη στεγανοποίηση επιφανειών. Αντιδρώντας με την υγρασία του αέρα μετατρέπεται σε μία ισχυρή και ελαστική μεμβράνη αδιαπέραστη στο νερό. Προσφέρει μακροχρόνια στεγανοποίηση και προστασία, υψηλή αντοχή σε λιμνάζοντα νερά χωρίς να ξεφλουδίζει. Διαθέτει εξαιρετική αντοχή στις καιρικές συνθήκες (βροχή, παγετό, ηλιακή ακτινοβολία) και διατηρεί την ελαστικότητά του ακόμη και σε πολύ χαμηλές θερμοκρασίες (-40°C).

Παρουσιάζει πολύ καλή ικανότητα γεφύρωσης τριχοειδών αρμών ή ρωγμών, είναι κατάλληλο για κυκλοφορία πεζών, παρέχει υψηλή ανακλαστικότητα, και σημαντική μείωση της θερμοκρασίας στους εσωτερικούς χώρους των κατασκευών τους καλοκαιρινούς μήνες. Διάρκεια ζωής: 12 μήνες τουλάχιστον από την ημερομηνία παραγωγής στην κλειστή αρχική συσκευασία μεταξύ +5°C και +25°C αποθηκευμένο σε στεγνό μέρος.

ΜΟΝΩΤΙΚΟ ΤΑΡΤΑΣΑΣ ΠΟΛΥΟΥΡΕΘΑΝΙΚΟ LASTOFLEX-PU

Barcode	Weight	Quantity
13997	1kg	1
13998	6kg	1
13999	25kg	1

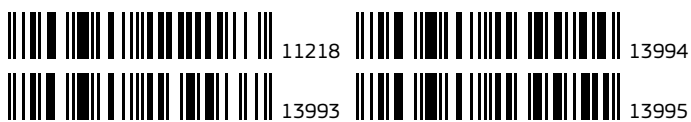

• Το ELASTOTET PRIMER VL εφαρμόζεται ως αστάρι πριν από την εφαρμογή μονωτικών ταρασών και σφραγιστικών αρμών σε υποστρώματα από μπετόν. Είναι επίσης κατάλληλο για χρήση ως αστάρι σε ξύλινα παρκέ πριν από την εφαρμογή παρκετόκολλας πολυουρεθάνης ή κόλλας με βάση πολυμερή τερματισμένα με σιλάνια.

ΑΣΤΑΡΙ ΠΟΛΥΟΥΡΕΘΑΝΙΚΟ PRIMER VL

Barcode	Weight	Quantity
11218	0,5kgr	12
13993	1kgr	6
13994	4kgr	1
13995	17kgr	1

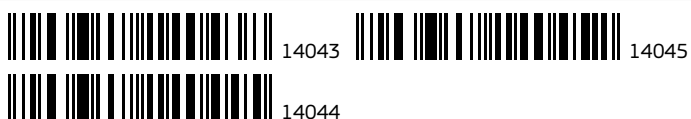

• Το ELASTOTET PRIMER DM είναι σιλανικό αστάρι για τη βελτίωση της πρόσφυσης πολυουρεθανικών υλικών σε λείες επιφάνειες. Στεγνώνει γρήγορα χωρίς να αλλοιώνει την όψη του υποστρώματος. Παρουσιάζει εξαιρετική πρόσφυση σε επιφάνειες από γυαλί, κεραμικά πλακάκια, βαμμένες μεταλλικές επιφάνειες. Είναι συμβατό με μεγάλη ποικιλία προϊόντων πολυουρεθάνης ενός ή δύο συστατικών. Εφαρμόζεται εύκολα με πινέλο ή πανί.

ΑΣΤΑΡΙ ΣΙΛΑΝΙΚΟ PRIMER DM

Barcode	Weight	Quantity
14043	0,5lt	1
14044	1lt	1
14045	4lt	1



• Αδιαβροχοποιητικό επαλειπτικό επιφανειών για προστασία από τη βροχή. Είναι ατμοπερατό και επιτρέπει την αναπνοή των δομικών στοιχείων. Είναι διαφανές και δεν αλλοιώνει τη χρωματική όψη των επιφανειών. Προστατεύει τις επιφάνειες από την εξίδρωση αλάτων (ιδιαίτερα των αλκαλικών υποστρωμάτων). Αδιαβροχοποιεί τους αρμούς πλακιδίων, προστατεύοντας από τη βρωμιά που συσσωρεύεται. Εφαρμόζεται εύκολα και γρήγορα.

ΑΔΙΑΒΡΟΧΟΠΟΙΗΤΙΚΟ ΕΠΙΦΑΝΕΙΩΝ SILIPROOF

Barcode	Weight	Quantity
14028	800ml	4

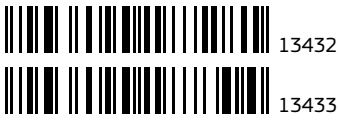

• Η μονταζόκολλα είναι κόλλα κατασκευών βασισμένη σε διαλύτες, ιδανική τόσο για εσωτερικές όσο και για εξωτερικές εφαρμογές. Το συγκολλητικό υλικό στεγνώνει γρήγορα και έχει ειδική διαμόρφωση για να αντέχει σε όλες τις καιρικές συνθήκες. Ιδανική για συγκόλληση πορωδών και μη υλικών όπως αλουμίνιο, μέταλλο, βινύλιο, ξύλο, τούβλο, σκυρόδεμα, ακρυλικό και πέτρα. Διάρκεια ζωής: 18 μήνες από την ημερομηνία παραγωγής στην κλειστή αρχική συσκευασία μεταξύ +5°C και +25°C αποθηκευμένο σε στεγνό μέρος.

ΚΟΛΛΑ MONTAGE

Barcode	Icon	Code	Icon
13432		80ml - code: 18728	12
13433		280ml - code: 18730	24

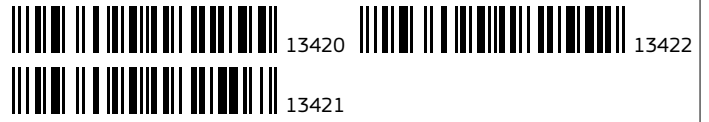

13420

13422

• Ξυλόκολλα με νέα σύνθεση, υψηλής ποιότητας, ταχείας συγκόλλησης, κατηγορίας D2. Όταν στεγνώσει γίνεται διάφανα και μπορεί να βαφτεί. Ιδανική για όλα τα είδη ξύλου: Πεύκο, έλατο, οξυά, δρύς, καρδιά κ.λπ. Διάρκεια ζωής: 24 μήνες από την ημερομηνία παραγωγής στην κλειστή αρχική συσκευασία μεταξύ +5°C και +25°C αποθηκευμένο σε στεγνό μέρος.

ΞΥΛΟΚΟΛΛΑ ΤΑΧΕΙΑΣ ΠΗΞΕΩΣ D2

Barcode	Icon	Code	Icon
13420		125gr - μπουκάλι - code: 18225	12
13421		250gr - μπιμπερό - code: 18250	6
13422		500gr - μπιμπερό - code: 18255	6



• Κυανοακρυλική κόλλα στιγμής χωρίς διαλύτες πολύ δυνατή με άμεσα αποτελέσματα συγκόλλησης. Ιδανική για τα περισσότερα υλικά όπως μέταλλο, λάστιχο, ξύλο, κεραμικά, γυαλί, πορσελάνη, χαρτόνι. Διάρκεια ζωής: 12 μήνες (φιαλίδιο) & 18 μήνες (σωληνάριο) από την ημερομηνία παραγωγής στην κλειστή αρχική συσκευασία μεταξύ +5°C και +25°C αποθηκευμένο σε στεγνό μέρος.

ΚΟΛΛΑ ΣΤΙΓΜΗΣ ΓΕΝΙΚΗΣ ΧΡΗΣΗΣ

Barcode	Icon	Code	Icon
13430		σετ 12x3gr - code: 18512	6
13431		25gr - φιαλίδιο - code: 18525	30



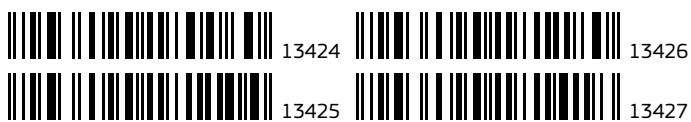

13424



13425

• Βενζινόκολλα χωρίς τολουόλη, πολύ ισχυρή για εφαρμογές τόσο σε εσωτερικούς όσο και σε εξωτερικούς χώρους. Με μεγάλη ελαστικότητα κατά τη συγκόλληση και με αντοχή στην υγρασία και το νερό.
Διάρκεια ζωής: 18 μήνες τουλάχιστον από την ημερομηνία παραγωγής στην κλειστή αρχική συσκευασία μεταξύ +5°C και +25°C αποθηκευμένο σε στεγνό μέρος.

ΒΕΝΖΙΝΟΚΟΛΛΑ

Barcode	Code	Quantity
13424	60ml - code: 18006	10
13425	100gr - code: 18110	10
13426	185gr - code: 18118	48
13427	410gr - code: 18141	36

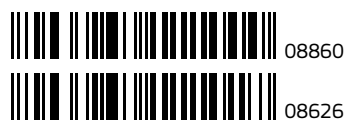

ΚΟΛΛΑ ΜΑΡΜΑΡΟΥ ΛΕΥΚΗ

Barcode	Code	Quantity
08860	250gr	30
08626	930gr	12

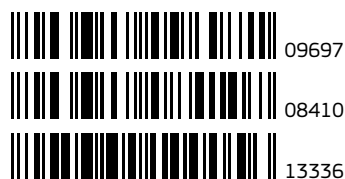

ΚΟΛΛΑ ΠΛΑΚΙΔΙΩΝ ΚΕΡΑΜΙΚΩΝ

Barcode	Code	Quantity
09697	2,5kgr	8
08410	5kgr	4
13336	25kgr	1



ΓΛΟΥΤΟΛΙΝΗ

Barcode	Code	Quantity
10390	125gr - πράσιν	5



ΠΥΡΟΚΟΛΛΑ

Barcode	Code	Quantity
08487	5kgr	4



08485



08486



10592



**ΠΑΡΕΤΙΝΑ ΕΤΟΙΜΟ
ΥΛΙΚΟ ΣΠΑΤΟΥΛΑΡΙΣΜΑΤΟΣ**

08485	2,5kgr	8
08486	5kgr	4
10592	20kgr	1



ΠΥΡΟΧΩΜΑ

09455	25kgr	1

	08317		07989
	08221		08360
	08378		08222
	07124		08402
	07217		07112
	07988		07113
	07110		08068



ΣΚΟΝΗ ΤΣΙΜΕΝΤΟΥ (ΟΞΕΙΔΙΟ ΣΙΔΗΡΟΥ)

08317	800gr - καφέ	10
08221	5kgr - καφέ	4
08378	25kgr - καφέ	1
07124	2kgr - κεραμιδί	7
07217	5kgr - κεραμιδί	4
07988	25kgr - κεραμιδί	1
07110	2kgr - μαύρη	5
07989	25kgr - μαύρη	1
08360	800gr - πράσινη	10
08222	5kgr - πράσινη	4
08402	25kgr - πράσινη	1
07112	2kgr - ώχρα	6
07113	5kgr - ώχρα	4
08068	25kgr - ώχρα	1

	07667		07670
	07668		07669



ΤΣΙΜΕΝΤΟ

07667	2,5kgr - λευκό	8
07668	5kgr - λευκό	4
07670	2,5kgr - μαύρο	10
07669	5kgr - μαύρο	4

	07672		07665
	07671		07666



GET IT NOW

ΓΥΨΟΣ

07672	2,5kgr - οικοδομών	8
07671	5kgr - οικοδομών	4
07665	2,5kg - καλλιτεχνείας	8
07666	5kg - καλλιτεχνείας	4



GET IT NOW



ΠΟΤΑΣΑ - ΣΟΔΑ (ΛΕΠΙ)

09167	20x1kg	1



09099



09101



ΣΚΟΝΗ ΤΣΙΓΚΟΥ (ΛΙΘΟΠΟΝΙΟ)

09099	2,5kg	8
09101	25kg	1



07171



07172



07173



• 100% ωμό λινέλαιο, κατάλληλο για λαδώματα εξωτερικής και εσωτερικής τοιχοποιίας, λαδώματα ξύλινων επιφανειών και για στόκους. Εφαρμόζεται σε περιπτώσεις ασταρώματος και λαδώματος σαθρών τοίχων. Βασική χρήση του είναι για την παρασκευή στόκου σπατουλαρίσματος με τον οποίο πριν τη βαφή με πλαστικό χρώμα, περνάμε την επιφάνεια του τοίχου με σκοπό να γεμίσουμε τους πόρους και τις ατέλειες που έχει.

ΛΙΝΕΛΑΙΟ ΩΜΟ

07171	750ml	20
07172	4lt	6
07173	16lt	1



ΣΤΕΓΝΩΤΙΚΟ (ΓΙΑ ΛΙΝΕΛΑΙΟ)

08279	750ml	16



• Κατάλληλο για εξωτερικούς χώρους, λάμπες, δάδες και καντήλια. ΑΟΣΜΟ, ΑΚΑΠΝΟ.

ΠΑΡΑΦΙΝΕΛΑΙΟ

07613	1lt	20

	08739		13443
	08736		12684
	08741		08740
	10451		08737
	08738		08742



• Υψηλής ποιότητας υπόστρωμα με μεγάλες αντισκληρωτικές ιδιότητες. Προστατεύει όλες τις σιδηρένιες επιφάνειες και τις προετοιμάζει για το τελικό βάψιμο. Στεγνώνει γρήγορα (20-40 λεπτά) και αντέχει σε υψηλές θερμοκρασίες (έως 100°C).

Είναι κατάλληλο για κάγκελα, δοκάρια, πόρτες και για κάθε είδους σιδηρένια επιφάνεια που έχει ανάγκη προστασίας από οξείδωση.

Δεν συνιστάται η εφαρμογή του προϊόντος σε θερμοκρασία κάτω από 6°C και πάνω από 40°C και όταν η σχετική υγρασία είναι μεγαλύτερη από 80%. Αντίξοες συνθήκες κατά την εφαρμογή μπορούν να αλλοιώσουν τις τελικές ιδιότητες του προϊόντος.

ΑΣΤΑΡΙΑ (MINIO) PRIMER

08739	375ml - γκρι	12
08736	750ml - γκρι	12
08741	2,5lt - γκρι	4
10451	375ml - κεραμιδί	12
08738	750ml - κεραμιδί	6
13443	2,5lt - κεραμιδί	4
12684	750ml - λευκό	6
08740	375ml - μαύρο	12
08737	750ml - μαύρο	6
08742	2,5lt - μαύρο	4

	10602		11518
--	-------	--	-------



• Ειδικό διαφανές αδιάβροχο υπόστρωμα με ισχυρή πρόσφυση και διεισδυτικότητα, κατάλληλο για εσωτερική και εξωτερική χρήση. Προσφέρει έτοιμη επιφάνεια για βαφή με υδατοδιαλυτά πλαστικά ή τσιμεντοχρώματα όσο και για μονωτικά ταρατσών ή κάθετων επιφανειών. Στεγνώνει πολύ γρήγορα και δεν κιτρινίζει. Είναι ιδανικό για τοίχους και ταρατσές. Δεν συνιστάται η εφαρμογή του προϊόντος σε θερμοκρασία κάτω από 6°C και πάνω από 40°C και όταν η σχετική υγρασία είναι μεγαλύτερη από 80%. Αντίξοες συνθήκες κατά την εφαρμογή μπορούν να αλλοιώσουν τις τελικές ιδιότητες του προϊόντος.

ΑΣΤΑΡΙΑ ΝΕΦΤΙΟΥ ΔΙΑΦΑΝΟ LIFE DUR

10602	750ml	6
11518	5lt	1

	12064		14538
--	-------	--	-------



• Ειδικό προϊόν, με πολύ καλή πρόσφυση σε μη σιδηρές επιφάνειες όπως αλουμίνιο, χαλκό, ανοξείδωτες και γαλβανιζέ επιφάνειες. Παρέχει υψηλή πρόσφυση και αντισκληρωτική προστασία. Στεγνώνει γρήγορα, έχει μεγάλη ελαστικότητα και δουλεύεται μαλακά με πολύ καλό άπλωμα. Δεν συνιστάται η εφαρμογή του προϊόντος σε θερμοκρασία κάτω από 6°C και πάνω από 40°C και όταν η σχετική υγρασία είναι μεγαλύτερη από 80%. Αντίξοες συνθήκες κατά την εφαρμογή μπορούν να αλλοιώσουν τις τελικές ιδιότητες του προϊόντος.

ΑΣΤΑΡΙΑ ΓΑΛΒΑΝΙΖΕ

12064	750ml	6
14538	2,5lt	4



• Πολυουρεθανικό αστάρι δύο συστατικών για την προστασία επιφανειών για πραγματικά ιδιαίτερες απαιτήσεις. Αποτελεί το ιδανικό υπόστρωμα για μεγάλη διάρκεια. Χρησιμοποιείται για ξύλα και ύφαλα σκαφών κατασκευασμένα από ξύλο, κόντρα πλακέ, πολυεστέρα ή μέταλλο και για πισίνες κατασκευασμένες από πολυεστέρα στις επιφάνειες εντός και εκτός νερού. Σαν γεμιστικό αν ο πολυεστέρας έχει ανωμαλίες, τρυπάκια κτλ. Επαναβάφεται μετά από 2-4 ώρες.



ΑΣΤΑΡΙ ΠΟΛΥΟΥΡΕΘΑΝΗΣ 2 ΣΥΣΤΑΤΙΚΩΝ (A+B) BLEND PRIMER

Barcode	Icon	Volume	Icon
11626		750ml - γκρι	4



• Ιδανικό λευκό υπόστρωμα για τοίχους και εσωτερικές ή εξωτερικές ξύλινες επιφάνειες. Εφαρμόζεται εύκολα, απλώνει θαυμάσια και προσφέρει μοναδική καλυπτική ικανότητα για την προετοιμασία του τελικού χρώματος.



ΒΕΛΑΤΟΥΡΑ ΛΕΥΚΗ VIVID

Barcode	Icon	Volume	Icon
09060		750ml	6



08800



12386



11427



10383



11428



08801



08792



11553



14037



10613



08802



09024



10384



ΒΕΡΝΙΚΟΧΡΩΜΑ STEP LAC

Barcode	Icon	Volume	Icon
08800		375ml - (653) γκρι σκούρο	12
11427		750ml - (653) γκρι σκούρο	6
11428		2,5lt - (653) γκρι σκούρο	4
08792		750ml - (618) καφέ ανοικτό	6
14037		750ml - (610) κεραμιδί	6
08802		375ml - (642) κίτρινο	12
10384		750ml - (642) κίτρινο	6
12386		375ml - (608) κόκκινο	12
10383		750ml - (608) κόκκινο	6
08801		375ml - (605) κυπαρισσί	12
11553		750ml - (605) κυπαρισσί	6
10613		2,5lt - (605) κυπαρισσί	4
09024		180ml - λευκό	12
09025		375ml - λευκό	12
08042		750ml - λευκό	12
08363		2,5lt - λευκό	4
10449		375ml - μαύρο	12
08043		750ml - μαύρο	12



09025



14903



08042



10340



08363



10386



10449



10450



08043



10387



08793



12397



• Γυαλιστερό βερνικόχρωμα (ριπολίνη) για εσωτερικές και εξωτερικές ξύλινες ή μεταλλικές επιφάνειες σπιτιών και σκαφών. Εφαρμόζεται εύκολα, απλώνει θαυμάσια, δίνει εξαιρετική γυαλάδα που διαρκεί και δεν κτρινίζει. Είναι εύκολο στη χρήση, έχει μεγάλη καλυπτικότητα και τέλειο άπλωμα.

08793	2,5lt - μαύρο	4
14903	375ml - (683) μπλε Αιγαίου	12
10340	750ml - (683) μπλε Αιγαίου	6
10386	750ml - (604) πράσινο	6
10450	375ml - (687) σοκολάτα	12
10387	750ml - (687) σοκολάτα	6
12397	180ml - χρυσό	12

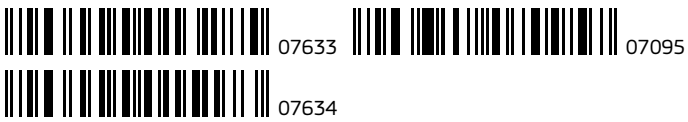

• Ειδικό στεγανωτικό υλικό, άχρωμο, ειδικά κατασκευασμένο για την διακόσμηση και την προστασία κάθε είδους πέτρας και συναφών οικοδομικών υλικών, όπως διακοσμητικά τούβλα, κεραμικά, πλάκες Καρύστου, πορόλιθο, κ.λπ. Εισχωρεί βαθιά στους πόρους και δίνει μια γυαλιστερή επιφάνεια που τονίζει τις ιδιαίτερες αποχρώσεις κάθε πετρώματος. Είναι ανθεκτικό στα κτυπήματα και στις φθορές από το περπάτημα, δεν κιτρινίζει, δεν ξεφλουδίζει και είναι εύκολο στη χρήση.

ΒΕΡΝΙΚΙ ΠΕΤΡΑΣ ΔΙΑΦΑΝΟ VIVID STONE

Barcode	Volume	Units
07633	750ml	6
07634	3lt	4
07095	20lt	1



• Βερνίκι ενός συστατικού αλκυδικής βάσεως για εσωτερική και εξωτερική χρήση. Προσφέρει μακροχρόνια προστασία και αντοχή σε όλα τα είδη ξύλου. Στεγνώνει γρήγορα και η γυαλάδα του μένει αναλλοίωτη στο χρόνο. Όσο περισσότερες στρώσεις περαστεί τόσο πιο πολύ τονίζονται τα φυσικά νερά του ξύλου

ΒΕΡΝΙΚΙ ΞΥΛΟΥ ΔΙΑΦΑΝΟ VIVID WOOD

Barcode	Volume	Units
07636	750ml	6

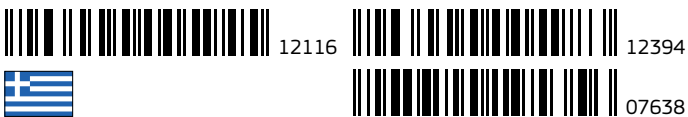

• Βερνίκι ενός συστατικού για εσωτερική και εξωτερική χρήση. Εφαρμόζεται σε πόρτες, κουφώματα, παράθυρα και κάθε είδους ξύλο. Προσφέρει μακροχρόνια προστασία και αντοχή σε όλα τα είδη ξύλου. Έχει μεγάλη ελαστικότητα και δεν ξεφλουδίζει ή φουσκώνει. Στεγνώνει γρήγορα και η γυαλάδα του μένει αναλλοίωτη στο χρόνο. Όσο περισσότερες στρώσεις εφαρμοστεί, τόσο πιο πολύ τονίζονται τα φυσικά νερά του ξύλου. Είναι σχεδόν άοσμο και εύκολο στη χρήση. Δεν συνίσταται η εφαρμογή του προϊόντος σε θερμοκρασία κάτω από 6°C και πάνω από 40°C και όταν η σχετική υγρασία είναι μεγαλύτερη από 80%. Αντίξοες συνθήκες κατά την εφαρμογή μπορούν να αλλοιώσουν τις τελικές ιδιότητες του προϊόντος.

ΒΕΡΝΙΚΙ ΞΥΛΟΥ RED SUN

Barcode	Volume	Units
12116	750ml - Καρυδιά σκούρα (858)	6
12394	750ml - Καστανιά σκούρα (859)	6
07638	20lt - Διάφανο	1





	08097		08729		07898		08755
	07631		09164		08842		09162
	07632		08077		09427		09165
	08727		13899		09428		08810
	08728		08756		09429		
	07630		09163		09430		



• Προστατευτικό ξύλινων επιφανειών, κατάλληλο για τη μακροχρόνια αντοχή όλων των ξύλινων επιφανειών που είναι εκτεθειμένες στο εξωτερικό περιβάλλον. Προσδίδει μεγάλη αντοχή στις καιρικές συνθήκες και τις προστατεύει από την υπεριώδη ακτινοβολία UVA & UVB του ηλίου.

ΣΥΝΤΗΡΗΤΙΚΟ ΞΥΛΟΥ WOOD CARE

08097	750ml - (800) διάφανο	6
07631	2,5lt - (800) διάφανο	4
07632	16lt - (800) διάφανο	1
08727	750ml - (802) δρυς	6
08728	2,5lt - (802) δρυς	4
07630	750ml - (808) καρυδιά σκούρα	6
08729	2,5lt - (808) καρυδιά σκούρα	4
09164	750ml - (803)Καρυδιά ανοικτή	6
08077	2,5lt - (803) καρυδιά ανοικτή	4
13899	2,5lt - (809) καστανιά σκούρα	4
08756	750ml - (806) μαόνι	6
09163	2,5lt - (806) μαόνι	4
07898	750ml - (807) όρεγκον	6
08842	2,5lt - (807) όρεγκον	4
09427	750ml - (811) παλίσανδρος	6



09428	2,5lt - (811) παλίσανδρος	4
09429	750ml - (814) πράσινο	6
09430	2,5lt - (814) πράσινο	4
08755	750ml - (810) τικ	6
09162	2,5lt - (810) τικ	4
09165	750ml - (805) τριαντάφυλλο	6
08810	2,5lt - (805) τριαντάφυλλο	4

	09484		07643
	07642		



• Κατάλληλο για εσωτερική και εξωτερική χρήση. Συνιστάται για την βαφή μεταλλικών επιφανειών όπως: καπνοδόχοι από σόμπες, μεταλλικές ψησταριές ή θερμάστρες.

Αντέχει στις υψηλές θερμοκρασίες (έως 400°C), στο φως, στη βροχή, στο ψύχος και γενικά στις δυσμενείς καιρικές συνθήκες.

ΑΛΟΥΜΙΝΙΟ ΦΩΤΙΑΣ

09484	170ml	12
07642	375ml	30
07643	750ml	24





14498



14496

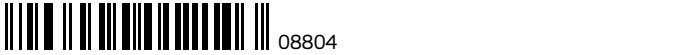

08804



• Πολυουρεθανικό χρώμα δύο συστατικών εξωτερικής χρήσεως, εξαιρετικά μεγάλης στιλπνότητας (γυαλάδας) και αντοχής. Ιδανικό όχι μόνο για την βαφή, αλλά και για την προστασία επιφανειών, με πραγματικά ιδιαίτερες απαιτήσεις όπως εξάλα σκαφών, πισίνες, μεταλλικές κατασκευές, καλοριφέρ και σωληνώσεις κλπ. Συνδυάζει πολύ καλή χημική και κατά της τριβής αντοχή με μεγάλη γυαλάδα και διατήρηση της απόχρωσης.

Έχει εξαιρετικές χημικές αντοχές. Επαναβάφεται μετά από 12 ώρες. Αποχρώσεις: διατίθεται σε Λευκό, κόκκινο, Μπλέ σκούρο, Θαλασσί.

ΧΡΩΜΑ ΠΟΛΥΟΥΡΕΘΑΝΙΚΟ 2 ΣΥΣΤΑΤΙΚΩΝ (A+B) POLYLAC (750 ml)

Barcode	Color	Volume
14498	θαλασσί (5012)	4
14496	κόκκινο	4
08804	λευκό	4
14497	μπλε σκούρο (5010)	4
04919	277ml - καταλύτης	1



14370



14371



• Υψηλής ποιότητας υπόστρωμα με μεγάλες αντισκωριακές ιδιότητες. Προστατεύει όλες τις σιδερένιες επιφάνειες και τις προετοιμάζει για το τελικό βάψιμο. Ο μηχανισμός προστασίας βασίζεται σε ιόντα φωσφορικού ψευδάργυρου. Εφαρμόζουμε εκεί όπου θέλουμε απόλυτη προστασία και πολύ μεγάλη αντοχή στην οξείδωση.



ΑΝΤΙΣΚΩΡΙΑΚΟ ΦΩΣΦΟΡΙΚΟΥ ΨΕΥΔΑΡΓΥΡΟΥ ZINC PRIMER

Barcode	Volume	Color
14370	750ml - γκρι	6
14371	2,5lt - γκρι	4



13413



• Ειδικό ανάγλυφο διακοσμτικό μεταλλίζε χρώμα. Προστατεύει όλες τις μεταλλικές επιφάνειες ενώ ταυτόχρονα προσφέρει ένα άψογο αισθητικό αποτέλεσμα. Εφαρμόζεται απευθείας στη σκουριά, χωρίς την ανάγκη αντισκωριακού ασαταριού. Λόγω της ειδικής του σύνθεσης, προσφέρει εξαιρετική αντιδιαβρωτική προστασία, σχηματίζοντας ένα αδιαπέραστο φράγμα κατά της υγρασίας τόσο σε νέες όσο και σε παλιές και ιδιαίτερα σκουριασμένες επιφάνειες. Δεν συνίσταται η εφαρμογή του προϊόντος σε θερμοκρασία κάτω από 6°C και πάνω από 40°C και όταν η σχετική υγρασία είναι μεγαλύτερη από 80%

ΧΡΩΜΑ ΜΕΤΑΛΛΙΖΕ FAST & RIGHT

Barcode	Volume	Color
13413	750ml - γκρι	6
13414	2,5lt - γκρι	4



15064

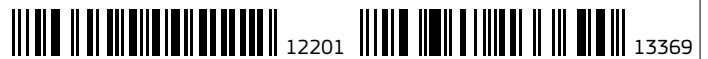

12201



• Ταχυστέγνωτο αντισκωριακό βερνικόχρωμα, ιδανικό για τη βαφή σασί αυτοκινήτων και όλων των μεταλλικών επιφανειών. Έχει μεγάλη καλυπτικότητα, ισχυρή πρόσφυση και μεγάλη ελαστικότητα. Παρουσιάζει εξαιρετική αντοχή στα χτυπήματα, στο πλύσιμο και τα πετρελαιοειδή. Μπορεί να χρησιμοποιηθεί και σαν αντισκωριακό υπόστρωμα για κάθε μεταλλική επιφάνεια.

ΧΡΩΜΑ ΣΑΣΙ CHASSIS COAT

Barcode	Volume	Color
15064	750ml - μαύρο	6
12201	750ml - κυπαρισσί	6
12202	2,5lt - κυπαρισσί	4
13369	2,5lt - κεραμίδι	4



13474



• Ειδικό χρώμα για την βαφή των πλακιδίων στο μπάνιο και την κουζίνα. Εφαρμόζεται απευθείας χωρίς υπόστρωμα και δημιουργεί άριστο αποτέλεσμα. Έχει εξαιρετική πρόσφυση και υψηλή αντοχή στο νερό, στην τριβή, στα σαπούνια κτλ.

Δεν συνίσταται η εφαρμογή του προϊόντος σε θερμοκρασία κάτω από 6°C και πάνω από 40°C και όταν η σχετική υγρασία είναι μεγαλύτερη από 80%. Αντίξοες συνθήκες κατά την εφαρμογή μπορούν να αλλοιώσουν τις τελικές ιδιότητες του προϊόντος.

ΧΡΩΜΑ ΠΛΑΚΙΔΙΩΝ ΛΕΥΚΟ TILE PAINT

Barcode	Icon	Volume	Quantity
13474		750ml	6
13475		2,5lt	4



12603



• Ιδανικό υπόστρωμα για όλες τις επιφάνειες πριν τη τελική βαφή. Έχει μεγάλη πρόσφυση και καλυπτικότητα. Ιδανικό για γυψοσανίδες, σπατουλαριστά, σοβά, χάρντμπορντ κ.λ.π. Ενισχύει την πρόσφυση του πλαστικού χρώματος και μειώνει την κατανάλωσή του. Λόγω της ακρυλικής του σύστασης μπορεί να χρησιμοποιηθεί και σε εξωτερικούς τοίχους.

Για αλλαγή της τελικής βαφής από υδρόχρωμα σε πλαστικό επιβάλλεται η εφαρμογή του.

ΑΣΤΑΡΙΑ ΠΛΑΣΤΙΚΟΥ ΒΑΣΗΣ ΝΕΡΟΥ STEP PRIMER

Barcode	Icon	Volume	Quantity
12603		750ml	6
08488		3lt	1



10429

08803



10562

10430

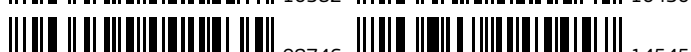

09746

14545

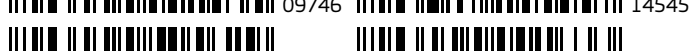

11429

14544

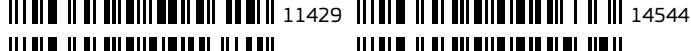

10564

10431

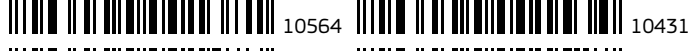

08203

10563

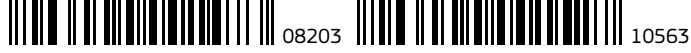

08202

08411



08434

10428

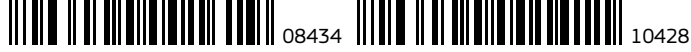

• Κορυφαία ποιότητα πλαστικό χρώμα για εσωτερική χρήση. Προσφέρει μεγάλη καλυπτικότητα. Δίνει βελούδινη επιφάνεια και απλώνει τέλεια. Δουλεύεται εύκολα με ρολό, πινέλο ή πιστόλι σε καθαρισμένη επιφάνεια. Έχει πολύ μεγάλη αντοχή στο συχνό πλύσιμο. Το προϊόν αποκτά όλες τις μηχανικές του αντοχές μετά από 20 - 30 μέρες.

Δεν συνίσταται η εφαρμογή του προϊόντος σε θερμοκρασία κάτω από 6°C και πάνω από 40°C και όταν η σχετική υγρασία είναι μεγαλύτερη από 80%. Αντίξοες συνθήκες κατά την εφαρμογή μπορούν να αλλοιώσουν τις τελικές ιδιότητες του προϊόντος.

ΧΡΩΜΑ ΒΑΣΗΣ STEP LATEX

Barcode	Icon	Volume	Quantity
10429		180ml - (405) καφέ	12
10562		750ml - (405) καφέ	6
09746		180ml - (403) κεραμιδί	12
11429		180ml - (401) κίτρινο	12
10564		750ml - (401) κίτρινο	6
08203		180ml - (404) κόκκινο	12
08202		750ml - (404) κόκκινο	6
08434		180ml - (408) μαύρο	12
08803		750ml - (408) μαύρο	12
10430		180ml - (407) μπλε	12
14545		180ml - (410) μωβ	12
14544		180ml - (409) πορτοκαλί	12
10431		180ml - (406) πράσινο	12
10563		750ml - (406) πράσινο	6
08411		180ml - (402) ώχρα	12
10428		750ml - (402) ώχρα	6



07104

07106

07105



• Ασφαλτικό γαλάκτωμα, υδατοδιαλυτό, δεν μυρίζει, δεν καίγεται και δεν περιέχει επικίνδυνους διαλύτες.

Εφαρμόζεται σαν φράγμα υδρατμών, για μονώσεις θεμελίων, τοίχων αντιστήριξης, δαπέδων, κεκλιμένων στεγών, συλλεκτήρων και αγωγών ομβρίων, προστασία οξειδωσις μπετόν, τούβλων, ξύλων.

ΠΙΣΣΑ ΝΕΡΟΥ

Barcode	Volume	Units
07104	800ml	12
07105	3lt	1
07106	9lt	1



07101

07103

07102



• Ασφαλτικό βερνίκι. Η πρόσφυσή του σε όλα τα δομικά υλικά αλλά κυρίως στο μπετόν (για το οποίο προορίζεται) είναι άριστη.

Εφαρμόζεται κυρίως για την στεγανοποίηση υπογείων τοιχίων και θεμελίων πριν την επικωμάτωση. Χρησιμοποιείται ακόμη για την στεγανοποίηση κεκλιμένων στεγών από μπετόν πριν την τοποθέτηση κεραμιδιών και για μικροεπισκευές ρωγμών σε οριζόντιες επιφάνειες.

Λόγω του υψηλού ιξώδους δημιουργεί παχύ υμένα και διευκολύνει την συγκόλληση ασφαλτικών μεμβρανών σε κατακόρυφες επιφάνειες.



ΠΙΣΣΑ ΔΙΑΛΥΤΟΥ

Barcode	Volume	Units
07101	800ml	12
07102	2lt	1
07103	16lt	1



07087



07088



07089



• Διαλυτικό χρωμάτων κατάλληλο για την αραιώση όλων των βερνικοχρωμάτων γενικής χρήσης (όχι βιομηχανικών ταχυστεγνωτων χρωμάτων). Χρησιμοποιείται για τον καθαρισμό των εργαλείων βαφής καθώς και για τον καθαρισμό χρωμολεκέδων.



ΔΙΑΛΥΤΙΚΟ WHITE SPIRIT

Barcode	Volume	Units
07087	500ml	35
07088	1lt	24
07089	4lt	6



• Διαλυτικό για υποστρώματα, βερνίκια και λάκες πολυουρεθάνης.

ΔΙΑΛΥΤΙΚΟ ΠΟΛΥΟΥΡΕΘΑΝΗΣ

Barcode	Volume	Units
08338	800ml	15



07091



07092



07093



• Το Ασετόν χρησιμοποιείται για καθαρισμό χρωμάτων-λεκέδων από οποιαδήποτε επιφάνεια, για καθαρισμό εργαλείων βαφής καθώς και για αραιώση ορισμένων χρωμάτων.



ΑΣΕΤΟΝ

Barcode	Volume	Units
07091	1lt	24
07092	4lt	6
07093	16lt	1

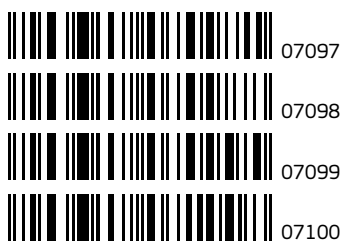

• Το γνήσιο ελληνικό νέφτι χρησιμοποιείται κατά βάση από επαγγελματίες για την κατασκευή Σέρτικου και άλλων επαγγελματικών μειγμάτων καθώς και για την αραίωση όλων των βερνικοχρωμάτων. Είναι κατάλληλο για τον καθαρισμό των εργαλείων και λεκέδων στο πάτωμα.

ΝΕΦΤΙ ΠΕΥΚΟΥ

Barcode	Quantity	Units
07097	375ml	40
07098	750ml	24
07099	4lt	5
07100	16lt	1

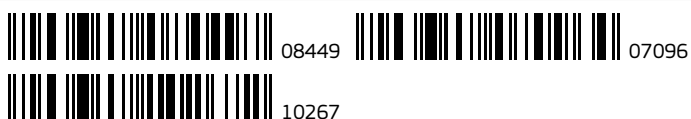

• Το διαλυτικό universal είναι άχρωμο διαλυτικό γενικής χρήσης, κατάλληλο για την αραίωση σε βερνίκια, χρώματα και αστάρια διαλύτου εξασφαλίζοντας γρήγορο στέγνωμα. Χρησιμοποιείται και για το καθαρισμό εργαλείων και εξαρτημάτων μετά το βάψιμο.

ΔΙΑΛΥΤΙΚΟ ΝΙΤΡΟΥ ΓΕΝΙΚΗΣ ΧΡΗΣΗΣ

Barcode	Quantity	Units
08449	800ml	15
10267	4lt	1
07096	16lt	1

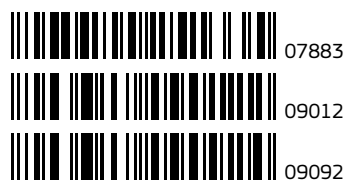

• Θιξοτροπικός πολυεστέρας κατάλληλος για κατασκευές και επισκευές ενισχυμένων πλαστικών (σκάφη αναψυχής, δεξαμενές, καλούπια), πλαστικοποιήσεις (σκάφη, βάρκες, τμήματα αυτοκινήτων, στέγαστρα), στεγανοποιήσεις (ζαρντινιέρες, δεξαμενές, ταράτσες). Χρόνος στεγνώματος: 10-30 λεπτά ανάλογα με τη θερμοκρασία του περιβάλλοντος και το ποσοστό καταλύτη.

ΠΟΛΥΕΣΤΕΡΑΣ ΣΕ ΜΕΤΑΛΛΙΚΟ ΔΟΧΕΙΟ (ΧΩΡΙΣ ΣΚΛΗΡΥΝΤΗ)

Barcode	Quantity	Units
07883	1kgr	12
09012	4kgr	4
09092	18kgr	1

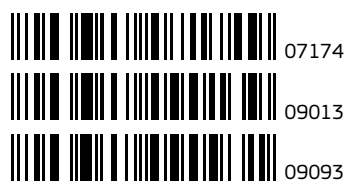

ΣΚΛΗΡΥΝΤΗΣ ΠΟΛΥΕΣΤΕΡΑ

Barcode	Quantity	Units
07174	για 1kgr	12
09013	για 4kgr	4
09093	για 18kgr	1



ΥΑΛΟΒΑΜΒΑΚΑΣ 450gr/m²

Barcode	Quantity	Units
07246	φάκελος	450gr

06343	09822
09442	09821
09487	09827
06300	06452
09486	04165
09485	12730
06458	06299
06459	06301
09829	09388
09828	09817
09823	09818
06506	09820
06297	06348
09824	09819



ΣΠΡΕΪ ΑΚΡΥΛΙΚΟ QUANTUM ΓΕΝΙΚΗΣ ΧΡΗΣΗΣ 400 ml

Barcode	Icon	Color	Quantity
06343		ασπμί γκρι (RAL 7001)	6
09442		βιολετί (RAL 4003)	6
09487		γκρι concrete (RAL 7023)	6
06300		γκρι ανοιχτό (RAL 7035)	6
09486		γκρι mouse (RAL 7005)	6
09485		γκρι signal (RAL 7004)	6
06458		καφέ ανοιχτό (RAL 8003)	6
06459		καφέ σοκολατί (RAL 8017)	6
09829		καφέ σέπια (RAL 8014)	6
09828		καφέ ελαφιού (RAL 8007)	6
09823		κίτρινο traffic (RAL 1023)	6
06506		κίτρινο κροκί (RAL 1007)	6
06297		κόκκινο traffic (RAL 3020)	6
09824		κόκκινο vermillion (RAL 2002)	6
09822		κόκκινο ρουμπινί (RAL 3003)	6
09821		κόκκινο φωτιάς (RAL 3000)	6
09827		κρεμ (RAL 9001)	6
06452		λευκό γυαλιστερό (RAL 9016)	6
04165		λευκό ματ (RAL 9016)	6

06303	07922
06645	09826
06682	06298
06674	09825
09387	06436



**HOT
SELLER**
**GET IT
NOW**

• Το quantum color spray είναι χρώμα σε μορφή σπρέι ακρυλικής βάσεως, κατάλληλο για εσωτερική και εξωτερική χρήση. Στεγνώνει γρήγορα και δεν στάζει ακόμη και όταν εφαρμόζεται σε κάθετες επιφάνειες. Έχει εξαιρετική αντοχή στην UV ακτινοβολία και μεγάλη αντοχή στην τριβή. Παρουσιάζει μεγάλη καλυπτική ικανότητα και δεν περιέχει προωθητικά που βλάπτουν το όζον. Είναι κατάλληλο για βαφή ή για σήμανση διαφόρων αντικειμένων και επιφανειών σε βιομηχανικές εφαρμογές, στον κλάδο αυτοκινήτου, σε οικοδομικές εφαρμογές καθώς και για οικιακή χρήση. Παρουσιάζει εξαιρετική πρόσφυση σε μεγάλη ποικιλία υποστρωμάτων όπως μέταλλα, αλουμίνιο, πλαστικά διαφόρων ειδών, ξύλο, γυαλί, πέτρες, σκυρόδεμα, κ.α.

12730	λευκό pure white (RAL 9010)	6
06299	μαύρο γυαλιστερό (RAL 4005)	6
06301	μαύρο ματ (RAL 4005)	6
09388	μπλε ναυτικού (RAL 5002)	6
09817	μπλε σκούρο (RAL 5003)	6
09818	μπλε traffic (RAL 5017)	6
09820	μπλε λιλά (RAL 4005)	6
06348	μπλε ουρανού (RAL 5015)	6
09819	μπλε τρκουάζ (RAL 5018)	6
06303	μπλε φωτεινό (RAL 5010)	6
06645	μπορντώ (RAL 3005)	6
06682	πορτοκαλί (RAL 2004)	6
06674	πράσινο κίτρινο (RAL 6018)	6
09387	πράσινο traffic (RAL 6024)	6
07922	πράσινο leaf (RAL 6002)	6
09826	πράσινο γρασιδιού (RAL 6010)	6
06298	πράσινο κυπαρισσί (RAL 6005)	6
09825	ρός ανοιχτό (RAL 3015)	6
06436	φίλντισι ανοιχτό (RAL 1015)	6



**QUANTUM SPRAY
COLOR GUIDE**



■ **NEW ARRIVAL** ΝΕΑ ΑΦΙΞΗ ■ **HOT SELLER** ΚΑΛΥΤΕΡΟ ΣΤΗΝ ΠΩΛΗΣΗ ■ **GET IT NOW** ΑΞΙΖΕΙ ΝΑ ΑΓΟΡΑΣΕΙΣ ΤΩΡΑ



QUANTUM COLOR SPRAY COLOR GUIDE

ΧΡΩΜΑΤΟΛΟΓΙΟ ΑΚΡΥΛΙΚΩΝ ΣΠΡΕΪ



RAL 1007
DAFFODIL YELLOW



RAL 1015
LIGHT IVORY



RAL 1023
TRAFFIC YELLOW



RAL 2002
VERMILION



RAL 2004
PURE ORANGE



RAL 3000
FLAME RED



RAL 3003
RUBY RED



RAL 3005
WINE RED



RAL 3015
LIGHT PINK



RAL 3020
TRAFFIC RED



RAL 4003
HEATHER VIOLET



RAL 4005
BLUE LILAC



RAL 5002
ULTRAMARINE BLUE



RAL 5003
SAPPHIRE BLUE



RAL 5010
GENTIAN BLUE



RAL 5015
SKY BLUE



RAL 5017
TRAFFIC BLUE



RAL 5018
TURQUOISE BLUE



RAL 6002
LEAF GREEN



RAL 6005
MOSS GREEN

ΣΠΡΕΥ ΧΡΩΜΑΤΟΣ ΑΚΡΥΛΙΚΗΣ ΒΑΣΗΣ

- Εφαρμογή σε επιφάνειες σε εξωτερικούς & εσωτερικούς χώρους
- Εξαιρετική αντοχή σε ακτινοβολία UV
- Σύνθεση γρήγορου στεγνώματος

RAL ACRYLIC ENAMEL SPRAY

- For indoor and outdoor applications
- Excellent UV radiation resistance
- Quick drying formula

ΧΡΩΜΑΤΟΛΟΓΙΟ ΑΚΡΥΛΙΚΩΝ ΣΠΡΕΪ



RAL 6010
YELLOW GREEN



RAL 6018
YELLOW GREEN



RAL 6024
TRAFFIC GREEN



RAL 7001
SILVER GREY



RAL 7004
SIGNAL GREY



RAL 7005
MOUSE GREY



RAL 7023
HEATHER VIOLET



RAL 7035
LIGHT GREY



RAL 8003
CLAY BROWN



RAL 8007
FAWN BROWN



RAL 8014
SEPIA BROWN



RAL 8017
CHOCOLATE BROWN



RAL 9001
CREAM



RAL 9005
JET BLACK GLOSS



RAL 9005
JET BLACK MATT



RAL 9010
PURE WHITE



RAL 9016
TRAFFIC WHITE GLOSS



RAL 9016
TRAFFIC WHITE MATT



QUANTUM COLOR SPRAY METALLIC

ΜΕΤΑΛΛΙΚΑ

- Εφαρμογή σε επιφάνειες σε εξωτερικούς & εσωτερικούς χώρους
- Εξαιρετική αντοχή σε ακτινοβολία UV
- Σύνθεση γρήγορου στεγνώματος

METALLIC

- For indoor and outdoor applications
- Excellent UV radiation resistance
- Quick drying formula

ΧΡΩΜΑΤΟΛΟΓΙΟ ΜΕΤΑΛΛΙΚΩΝ ΣΠΡΕΪ



LIGHT GOLD



RICH GOLD



COOPER GOLD



SILVER LIGHT



NIKEL



METAL RED



METAL BLUE



METAL BLACK



QUANTUM COLOR SPRAY HIGH TEMPERATURE

ΥΨΗΛΩΝ ΘΕΡΜΟΚΡΑΣΙΩΝ

- Αντοχή σε θερμοκρασίες έως 350°C/ 660°F

HIGH TEMPERATURE

- Resistance in temperatures up to 350°C/ 660°F

ΧΡΩΜΑΤΟΛΟΓΙΟ ΓΙΑ ΦΘΟΡΙΖΟΝΤΑ & ΣΠΡΕΪ ΥΨΗΛΗΣ ΘΕΡΜΟΚΡΑΣΙΑΣ



BLACK



RED



SILVER



WHITE



BROWN

QUANTUM COLOR SPRAY FLUORESCENT



F10 GREEN



F11 RED



F12 YELLOW



F14 ORANGE



ΦΘΟΡΙΖΟΝΤΑ

- Εφαρμογή σε επιφάνειες σε εξωτερικούς & εσωτερικούς χώρους
- Εξαιρετική αντοχή σε ακτινοβολία UV
- Σύνθεση γρήγορου στεγνώματος
- Τεχνολογία για extra φωτεινό αποτέλεσμα

FLUORESCENT

- For indoor and outdoor applications
- Excellent UV radiation resistance
- Quick drying formula
- Extra bright effect formulation



GALVANIZE

QUANTUM TECHNICAL SPRAY

ΧΡΩΜΑΤΟΛΟΓΙΟ ΤΕΧΝΙΚΩΝ ΣΠΡΕΪ



WHITE PRIMER



GLOSS VARNISH



MATT VARNISH



RED PRIMER



GRAY PRIMER



WHEEL RIM



SMALTO



• Υψηλής ποιότητας καθαριστικός αφρός ταπετσαρίας και υφασμάτων. Καθαρίζει γρήγορα και αποτελεσματικά τα υφάσματα από λίπη, λάδια, βρωμιά, ενώ ταυτόχρονα αρωματίζει ευχάριστα. Στεγνώνει γρήγορα χωρίς να αφήνει κατάλοιπα. Κατάλληλο και για τον καθαρισμό των καθισμάτων, των πατακιών, των μοκετών και των υφασμάτων των επιφανειών στο εσωτερικό των οχημάτων.



ΣΠΡΕΪ ΚΑΘΑΡΙΣΜΟΥ ΤΑΠΕΤΣΑΡΙΑΣ QUANTUM

07628	400ml	6



09402



09397



09403



06453



04655



06349



09404



09775



• Χρώμα σε μεταλλικές αποχρώσεις σε μορφή σπρέι. Στεγνώνει γρήγορα και δεν στάζει ακόμη και όταν εφαρμόζεται σε κάθετες επιφάνειες. Έχει εξαιρετική αντοχή στην UV ακτινοβολία και μεγάλη αντοχή στην τριβή. Παρουσιάζει μεγάλη καλυπτική ικανότητα και δεν περιέχει προωθητικά που βλάπτουν το όζον. Είναι κατάλληλο για βαφή ή σήμανση διαφόρων αντικειμένων και επιφανειών σε βιομηχανικές εφαρμογές, στον κλάδο αυτοκινήτου, σε οικοδομικές εφαρμογές καθώς και για διακοσμητικές εφαρμογές ή οικιακή χρήση. Παρουσιάζει εξαιρετική πρόσφυση σε μεγάλη ποικιλία υποστρωμάτων όπως μέταλλα, αλουμίνιο, ξύλο, γυαλί, πέτρες, σκυρόδεμα, πλαστικά διαφόρων ειδών, κ.α.



ΣΠΡΕΪ ΜΕΤΑΛΛΙΚΟ QUANTUM 400 ml

09402	ασμηί silver light	6
09403	κόκκινο metal red	6
04655	μαύρο metal black	6
09404	μπλε metal blue	6
09397	νίκελ	6
06453	χαλκός copper gold	6
06349	χρυσός light gold	6
09775	χρυσός rich gold	6



07622



07621



04943



• Το quantum color spray είναι χρώμα σε μορφή σπρέι ακρυλικής βάσεως, σε φθορίζουσες αποχρώσεις κατάλληλο για εσωτερική και εξωτερική χρήση. Στεγνώνει γρήγορα και δεν στάζει ακόμη και όταν εφαρμόζεται σε κάθετες επιφάνειες. Έχει εξαιρετική αντοχή στην UV ακτινοβολία και μεγάλη αντοχή στην τριβή. Παρουσιάζει μεγάλη καλυπτική ικανότητα και δεν περιέχει προωθητικά που βλάπτουν το όζον. Είναι κατάλληλο για βαφή ή για σήμανση διαφόρων αντικειμένων και επιφανειών σε βιομηχανικές εφαρμογές, στον κλάδο αυτοκινήτου, σε οικοδομικές εφαρμογές καθώς και για οικιακή χρήση. Παρουσιάζει εξαιρετική πρόσφυση σε μεγάλη ποικιλία υποστρωμάτων όπως μέταλλα, αλουμίνιο, πλαστικά διαφόρων ειδών, ξύλο, γυαλί, πέτρες, σκυρόδεμα, κ.α.



ΣΠΡΕΪ ΦΘΟΡΙΖΟΝ QUANTUM ΓΕΝΙΚΗΣ ΧΡΗΣΗΣ 400 ml

07622	κίτρινο F12	6
07621	κόκκινο F11	6
04943	πράσινο F10	6



00006



10655



• Διαφανές ακρυλικό βερνίκι σε μορφή σπρέι, κατάλληλο για τη προστασία διαφόρων επιφανειών, κατάλληλο για εσωτερική και εξωτερική χρήση. Είναι ιδιαίτερα ανθεκτικό στην ακτινοβολία UV και δεν κιτρινίζει. Γυαλίζει και προστατεύει από τις φθορές και δεν περιέχει προωθητικά που βλάπτουν το όζον. Είναι κατάλληλο για εφαρμογή σε ξύλα, μέταλλα, πέτρες, πλαστικά, κ.α. Χρησιμοποιείται για την προστασία και το γυάλισμα διαφόρων επιφανειών στην βιομηχανία, στην επιπλοποιία, στο αυτοκίνητο ή στο σπίτι.



ΣΠΡΕΪ ΒΕΡΝΙΚΙ ΔΙΑΦΑΝΟ QUANTUM 400 ml

00006	γυαλιτερό	6
10655	ματ	6



GET IT NOW



• Χρώμα σε μορφή σπρέι με αντοχή σε υψηλές θερμοκρασίες (έως 350°C). Στεγνώνει γρήγορα και δεν στάζει ακόμη και όταν εφαρμόζεται σε κάθετες επιφάνειες. Έχει εξαιρετική αντοχή στην UV ακτινοβολία και μεγάλη αντοχή στη τριβή.

Παρουσιάζει μεγάλη καλυπτική ικανότητα και δεν περιέχει προωθητικά που βλάπτουν το όζον. Είναι κατάλληλο για εφαρμογή σε σωληνώσεις θέρμανσης, εξατμίσεις αυτοκινήτων, συστήματα κεντρικής θέρμανσης κτιρίων, καμινάδες, φούρνους, σε μαγειρικές εστίες, σχάρες μπάρμπεκιου, τζάκια, κ.α. Παρουσιάζει εξαιρετική πρόσφυση σε μεγάλη ποικιλία υποστρωμάτων όπως μέταλλα, αλουμίνιο, ξύλο, γυαλί, πέτρες, σκυρόδεμα, κ.α.

ΣΠΡΕΪ ΥΨΗΛΗΣ ΘΕΡΜΟΚΡΑΣΙΑΣ QUANTUM 400 ml

Barcode	Color	Volume
07334	ασημί	6
09425	καφέ	6
09424	κόκκινο	6
07629	λευκό	6
07315	μαύρο	6



• Αστάρι μετάλλων σε μορφή σπρέι κατάλληλο για τη προστασία μεταλλικών επιφανειών. Βελτιώνει τη πρόσφυση των τελικών βαφών. Στεγνώνει γρήγορα και είναι συμβατό με όλα τα συνήθη χρώματα διαλύτου (ακρυλικά, αλκυδικά, νιτροκυταρίνης).

Δεν περιέχει προωθητικά που βλάπτουν το όζον.

Εφαρμόζεται σε μεταλλικές επιφάνειες πριν από την τελική βαφή, προσφέροντας υψηλή αντισκωριακή προστασία.

ΣΠΡΕΪ ΑΣΤΑΡΙ QUANTUM 400 ml

Barcode	Color	Volume
10010	γκρι	6
10009	κόκκινο	6
10025	λευκό	6



• Μεταλλικό χρώμα σε μορφή σπρέι κατάλληλο για βαφή σε ζάντες. Στεγνώνει γρήγορα και δεν στάζει ακόμη και όταν εφαρμόζεται σε κάθετες επιφάνειες. Έχει εξαιρετική αντοχή στην UV ακτινοβολία, μεγάλη αντοχή στη τριβή και τους ρύπους και προστατεύει από τη σκουριά. Παρουσιάζει μεγάλη καλυπτική ικανότητα και δεν περιέχει προωθητικά που βλάπτουν το όζον. Είναι κατάλληλο για βαφή όλων των τύπων των μεταλλικών ζαντών.

ΣΠΡΕΪ ΖΑΝΤΑΣ QUANTUM 400 ml

Barcode	Color	Volume
07617	νίκελ	6



• Ταχυστέγνωτο χρώμα ακρυλικής βάσεως σε μορφή σπρέι, κατάλληλο για βαθιά λευκών οικιακών συσκευών και ειδών υγιεινής. Δεν στάζει ακόμη και όταν εφαρμόζεται σε κάθετες επιφάνειες και έχει εξαιρετική αντοχή στην UV ακτινοβολία. Είναι ανθεκτικό στις γρατζουνιές, προστατεύει από τη σκουριά και παρουσιάζει άριστη καλυπτική ικανότητα με ένα πέρασμα. Δεν περιέχει προωθητικά που βλάπτουν το όζον.



ΣΠΡΕΪ ΣΜΑΛΤΟ QUANTUM 400 ml



02968

λευκό

6



• Ισχυρό αφαιρετικό χρωμάτων σε μορφή σπρέι. Αφαιρεί γρήγορα και αποτελεσματικά παλαιά χρώματα, βερνίκια, ή κόλλες από τις επιφάνειες στις οποίες εφαρμόζεται. Είναι κατάλληλο για τους περισσότερους τύπους χρωμάτων όπως οικοδομικά, βερνικοχρώματα, βαφές πολυουρεθάνης κ.α. Κατάλληλο για τον καθαρισμό των επιφανειών από χρώματα, βερνίκια ή άλλες συνθετικές ουσίες, για εφαρμογή σε μεταλλικές ή ξύλινες επιφάνειες, σε τοίχους από μπέτον ή σοβά, σε πλακάκια, σε τζάμια, κ.α. Προτείνεται δοκιμή πριν από χρήση σε ευαίσθητες επιφάνειες.



ΣΠΡΕΪ PAINT REMOVER QUANTUM 400 ml

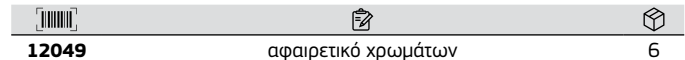

12049

αφαιρετικό χρωμάτων

6



HOT
SELLER

• Προστατευτικό επίχρισμα σε μορφή σπρέι πλούσιο σε περιεκτικότητα φυλλιδίων ψευδαργύρου (99%). Προσφέρει μακρόχρονη αντισκωριακή προστασία σε όλες τις σιδηρές κατασκευές. Προσφύεται ηλεκτροχημικά στις επιφάνειες του σιδήρου ή του χάλυβα δημιουργώντας ένα επιφανειακό φιλμ το οποίο προσφέρει εξίσου αποτελεσματική προστασία (όσον αφορά στην αντοχή στο χρόνο του φιλμ και στη προστασία διάβρωσης από άλατα) με την εμβάπτιση του θερμού γαλβανισμού. Μπορεί να χρησιμοποιηθεί και ως αστάρι για της συνήθεις βαφές ενώ παρουσιάζει καλή ηλεκτρική αγωγιμότητα και μεγάλη καλυπτική ικανότητα. Δεν στάζει ακόμη και όταν εφαρμόζεται σε κάθετες επιφάνειες και δεν περιέχει προωθητικά που βλάπτουν το όζον. Είναι ιδιαίτερα κατάλληλο για σημειακές επαναβαφές σε πολυκαιρισμένες γαλβανισμένες επιφάνειες ή επιφάνειες που έχουν αλλοιωθεί από τις συγκολλήσεις.



ΣΠΡΕΪ ΓΑΛΒΑΝΙΣΜΑ QUANTUM 400 ml



06246

ψυχρό

6



• Γυαλιστικό ταμπλό με βάση τη σιλικόνη. Προσφέρει μακρόχρονη γυαλάδα και προστασία ενώ ταυτόχρονα αρωματίζει ευχάριστα το εσωτερικό του οχήματος και εμποδίζει την επικάλυψη σκόνης. Κατάλληλο για την προστασία και το γυάλισμα των ταμπλό και των υπόλοιπων πλαστικών επιφανειών του αυτοκινήτου.



ΣΠΡΕΪ ΓΥΑΛΙΣΤΙΚΟ ΤΑΜΠΛΟ QUANTUM 400 ml



12722

cockpit

6



NEW
ARRIVAL



• Ισχυρό καθαριστικό για τα φρένα οχημάτων. Καθαρίζει από τα υπολείμματα λαδιών, κάρβουνα, σκόνης. Παρουσιάζει πολύ ισχυρή καθαριστική ικανότητα, χωρίς να αφήνει υπολείμματα. Δεν είναι αγώγιμο και δεν είναι διαβρωτικό ενώ παρουσιάζει ταχύτατο στέγνωμα. Κατάλληλο για τον καθαρισμό των δισκώφρενων, των ταμπούρων, των δαγκάνων, των τακακίων, κ.α.

ΣΠΡΕΪ ΚΑΘΑΡΙΣΤΙΚΟ ΦΡΕΝΩΝ 400 ml (BRAKE CLEANER) QUANTUM

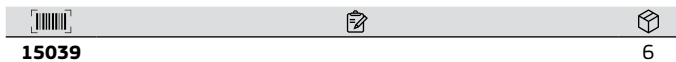

15039

6



• Χρώμα ακρυλικό σε μορφή σπρέϊ κατάλληλο για τη βαφή προφυλακτήρων. Στεγνώνει γρήγορα και δεν στάζει ακόμη και όταν εφαρμόζεται σε κάθετες επιφάνειες. Εξαιρετική αντοχή στην ηλιακή ακτινοβολία, τα κτυπήματα και τις γρατζουνιές. Διαθέτει άριστη πρόσφυση σε επιφάνειες από σκληρά πλαστικά με εξαίρεση το πολυαιθυλένιο, το πολυπροπυλένιο, και το τεφλόν. Δημιουργεί ένα σατινέ φινιρίσμα με μεγάλη αντοχή στις μηχανικές καταπονήσεις. Παρουσιάζει εξαιρετική πρόσφυση σε μεγάλη ποικιλία υποστρωμάτων όπως μέταλλα, αλουμίνιο, διαφόρων ειδών πλαστικά, ξύλο, γυαλί, πέτρες, σκυρόδεμα, κ.α.

ΣΠΡΕΪ ΠΡΟΦΥΛΑΚΤΗΡΩΝ QUANTUM 400 ml



12485

μάυρο

6



• Σπρέϊ σιλικόνης για λίπανση, προστασία και αδιαβροχοποίηση μεταλλικών, πλαστικών και ελαστικών εξαρτημάτων. Δημιουργεί ένα διάφανο και αντικολλητικό φιλμ, ενώ παρουσιάζει εξαιρετική αντοχή στην ηλιακή ακτινοβολία καθώς και στις υψηλές και χαμηλές θερμοκρασίες (από -50°C έως $+200^{\circ}\text{C}$). Λιπαίνει και προστατεύει διαφόρων ειδών εξαρτήματα (μεταλλικά, πλαστικά, ελαστικά) από τη φθορά και το τρίξιμο. Εφαρμόζεται σε πόρτες, κλειδαριές, μεντεσέδες, ράουλα, κ.α. Εμποδίζει το πάγωμα και τη σκλήρυνση των ελαστικών. Είναι κατάλληλο για αδιαβροχοποίηση επιφανειών όπως υφάσματα, ξύλα, τέπτες, ομπρέλες, κ.α. Είναι επίσης κατάλληλο σαν αντικολλητικό για εφαρμογές καλουπιών.

ΣΠΡΕΪ ΣΙΛΙΚΟΝΗΣ QUANTUM 400 ml



06243

συντήρησης

6



• Προστατευτικό από ελαστικό καουτσούκ για την προστασία των αφανών επιφανειών των αμαξωμάτων. Είναι εξαιρετικά ελαστικό με άριστη πρόσφυση στις εφαρμοζόμενες επιφάνειες και με ηχοαπορροφητικές ιδιότητες. Προστατεύει το αμάξωμα από τη διάβρωση, την υγρασία, τις πέτρες ή τα χαλίκια του οδοστρώματος. Μπορεί να βαφτεί με υδατοδιαλυτά χρώματα και με τα συνήθη χρώματα αυτοκινήτου.

ΣΠΡΕΪ ΠΙΣΣΑΣ QUANTUM 400 ml

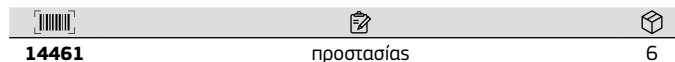

14461

προστασίας

6



NEW ARRIVAL

• Λιπαντικό σπρέϊ πολλαπλών χρήσεων για καθαρισμό, προστασία και ξεμπλοκάρισμα μηχανικών εξαρτημάτων. Ξεμπλοκάρει παξιμάδια, βίδες και μηχανικά εξαρτήματα τα οποία έχουν μπλοκαριστεί από την σκουριά. Λιπαίνει κινούμενους μηχανισμούς, ηλεκτρονικά εξαρτήματα, εξαρτήματα αυτοκινήτων, ποδηλάτων. Περιέχει ατμώδεις αναστολείς διάβρωσης που δημιουργούν ένα μοριακό ανασταλτικό στρώμα ιόντων με αποτέλεσμα την πολύ καλή προστασία από την ατμοσφαιρική προσβολή ή από τα άλατα. Προσφέρει αντιοξειδωτική λειτουργία για ηλεκτρικές και ηλεκτρονικές επαφές. Απομακρύνει το νερό ή την υγρασία από τις επιφάνειες πάνω στις οποίες εφαρμόζεται. Προστατεύει από το πάγωμα μηχανικά μέρη των αυτοκινήτων και εξαρτήματα κινητήρων. Καθαρίζει και αφαιρεί γράσα, λάδια, κόλλες, κλπ., από τις επιφάνειες πάνω στις οποίες εφαρμόζεται. Είναι κατάλληλο για ναυτιλιακές εφαρμογές για τον καθαρισμό, τη λίπανση και την προστασία σε σκάφη, εξοπλισμό ψαρέματος, και εξαρτήματα μηχανών τα οποία βρίσκονται σε επαφή με το θαλασσινό νερό.

ΣΠΡΕΪ ΑΝΤΙΣΚΩΡΙΑΚΟ 400 ml QUANTUM

14529	ειδικός ανάτπτορας	12



• Γράσο λιθίου σε μορφή σπρέϊ υψηλών απαιτήσεων, κατάλληλο για τη λίπανση αλυσίδων, ρουλεμάν και άλλων κινούμενων μηχανικών εξαρτημάτων. Παρουσιάζει υψηλή μηχανική και θερμική αντοχή, εμποδίζει τη φθορά και το κόλλημα των μηχανικών μερών. Προστατεύει από τη διάβρωση και από τις καιρικές συνθήκες. Είναι ανθεκτικό σε ήπια οξέα και βάσεις. Έχει υδατοαπωθητικές ιδιότητες και είναι εύκολο στη χρήση με στοχευμένο ψεκασμό χωρίς να στάζει.

ΣΠΡΕΪ ΓΡΑΣΟ QUANTUM 400 ml

10131	λιθίου	6



GET IT NOW

• Λιπαντικό σπρέϊ πολλαπλών χρήσεων για καθαρισμό, προστασία και ξεμπλοκάρισμα μηχανικών εξαρτημάτων. Ξεμπλοκάρει παξιμάδια, βίδες και μηχανικά εξαρτήματα τα οποία έχουν μπλοκαριστεί από την σκουριά. Λιπαίνει κινούμενους μηχανισμούς, ηλεκτρονικά εξαρτήματα, εξαρτήματα αυτοκινήτων, ποδηλάτων. Περιέχει ατμώδεις αναστολείς διάβρωσης που δημιουργούν ένα μοριακό ανασταλτικό στρώμα ιόντων με αποτέλεσμα την πολύ καλή προστασία από την ατμοσφαιρική προσβολή ή από τα άλατα. Προσφέρει αντιοξειδωτική λειτουργία για ηλεκτρικές και ηλεκτρονικές επαφές. Απομακρύνει το νερό ή την υγρασία από τις επιφάνειες πάνω στις οποίες εφαρμόζεται. Προστατεύει από το πάγωμα μηχανικά μέρη των αυτοκινήτων και εξαρτήματα κινητήρων. Καθαρίζει και αφαιρεί γράσα, λάδια, κόλλες, κλπ., από τις επιφάνειες πάνω στις οποίες εφαρμόζεται. Είναι κατάλληλο για ναυτιλιακές εφαρμογές για τον καθαρισμό, τη λίπανση και την προστασία σε σκάφη, εξοπλισμό ψαρέματος, και εξαρτήματα μηχανών τα οποία βρίσκονται σε επαφή με το θαλασσινό νερό.

ΣΠΡΕΪ ΑΝΤΙΣΚΩΡΙΑΚΟ QUANTUM

12477	200ml	12
12478	400ml	12



• Το glue spray είναι μία ταχυστέγνωτη κόλλα σε μορφή σπρέι γενικής χρήσης. Στεγνώνει γρήγορα και δεν στάζει ακόμη και όταν εφαρμόζεται σε κάθετες επιφάνειες.
 Διαθέτει εξαιρετική πρόσφυση σε μεγάλη ποικιλία υποστρωμάτων όπως γυαλί, ξύλο, μέταλλο, πλαστικό, δέρμα, ύφασμα, χαρτόνι, λάστιχο, μοκέτα, συνθετικό πάτωμα κ.α.

ΣΠΡΕΪ ΚΟΛΛΑ QUANTUM 400 ml

11907	γενικής χρήσης	6



ΕΚΘΕΤΗΡΙΟ ΣΠΡΕΪ QUANTUM (ΤΡΟΧΗΛΑΤΟ)

07923	(n x β x u) 59x48x188cm	1



Den Braven



• Το DB Zinc είναι σπρέϊ ψυχρού γαλβανίσματος εξαιρετικής ποιότητας για προστασία από τη διάβρωση. Βάφεται και αντέχει σε θερμοκρασίες έως 500οC. Εξαιρετική πρόσφυση σε όλα τα μέταλλα. Περιεκτικότητα σε ψευδάργυρο πάνω από 90%. Κατάλληλο για προστασία σε γαλβανισμένες επιφάνειες μετά από κολλήσεις, κόψιμο, τρύπημα, και γενικά όπου έχει φύγει το γαλβάνισμα. Μπορεί να χρησιμοποιηθεί και ως αστάρι.

ΣΠΡΕΪ ΓΑΛΒΑΝΙΣΜΑ 400 ml

10188 ψυχρό 12



Den Braven



• Λιπαντικό σπρέϊ υψηλής περιεκτικότητας σε σιλικόνη με αδιαβροχοποιητικές ιδιότητες. Απωθεί τη σκόνη και τη βρωμιά μειώνοντας τις τριβές. Προστατεύει λάστιχα και πλαστικά μέρη από σκλήρυνση. Λιπαίνει και προστατεύει μεντεσέδες, ράουλα, ρουλεμάν, ταμπλό κλπ. Αντέχει σε ακραίες θερμοκρασίες.

ΣΠΡΕΪ ΣΙΛΙΚΟΝΗΣ 400 ml

10187 συντήρησης 12



Den Braven



• Το DB Zinc-Alu είναι σπρέϊ ψυχρού γαλβανίσματος με περιεκτικότητα σε αλουμίνιο και γυαλιστερό φινίρισμα για προστασία από τη διάβρωση. Βάφεται και αντέχει σε θερμοκρασίες έως 200°C. Έχει την ίδια όψη με την επιφάνεια γαλβανίσματος εν θερμό. Εξαιρετική πρόσφυση σε όλα τα μέταλλα. Προστατεύει από την οξειδωση σημεία όπου έχει φύγει το γαλβάνισμα όπως: κοψίματα, κολλήσεις χτυπήματα κλπ. Για εφαρμογές στον τομέα του κλιματισμού και του εξαερισμού, των συστημάτων θέρμανσης, μεταλλικές κατασκευές κλπ

ΣΠΡΕΪ ΓΑΛΒΑΝΙΣΜΑ 400 ml

10583 αλουμινίου 12



Den Braven



• Το DB V-belt είναι σπρέϊ για ιμάντες που είναι εκτεθειμένοι σε υγρασία και διαβρωτικό περιβάλλον. Διεισδύει βαθιά στους πόρους απωθώντας την σκόνη, το νερό και την υγρασία. Σταματά τους θορύβους από την ολίσθηση και προσφέρει προστασία για μεγάλο χρονικό διάστημα. Δραστικό ακόμα και σε θαλασσινό περιβάλλον. Κατάλληλο για ιμάντες που πατινάρουν πάνω σε μηχανήματα, γεννήτριες και μοτέρ αυτοκινήτων. Κατάλληλο για ιμάντες όλων των τύπων.

ΣΠΡΕΪ ΓΙΑ ΙΜΑΝΤΕΣ 400 ml

10231 προστασίας 12



Den Braven



• Σπρέι εξαιρετικής ποιότητας για λίπανση και συντήρηση αλυσίδων. Καθιστά την κίνηση των αλυσίδων ήρεμη και συνεχή. Απωθεί την υγρασία και προστατεύει από τη διάβρωση. Έχει πολύ καλή πρόσφυση και δε στάζει κατά την εφαρμογή του. Κατάλληλο για λίπανση αλυσίδων σε μοτοσικλέτες, μηχανές, βιομηχανικά εργαλεία, ρουλεμάν, συρματόσχοινα κλπ. Δεν στάζει, δεν λεκιάζει ενώ παρουσιάζει ισχυρή πρόσφυση ακόμη και σε αλυσίδες ταχείας περιστροφής. Παράγει ομαλή και ήσυχη λειτουργία.

ΣΠΡΕΪ ΑΛΥΣΙΔΩΝ 400 ml

10232	λιπαντικό	12



Den Braven



• Σπρέι καθαρισμού καρμπυρατέρ ειδικού μείγματος για μεγαλύτερη απόδοση. Συνδυασμός καθαρισμού και λίπανσης. Δεν διαβρώνει τις ελαστικές μεμβράνες και τα μέταλλα με τα οποία έρχεται σε επαφή. Αφαιρεί κατάλοιπα, λάδια κλπ. Κατάλληλο για αποτελεσματικό καθαρίσμα εσωτερικά και εξωτερικά σε καρμπυρατέρ. Ιδανικό για τον καθαρισμό της πεταλούδας και της εισαγωγής injection σε οχήματα.

ΣΠΡΕΪ ΚΑΡΜΠΥΡΑΤΕΡ 400 ml

09950	καθαριστικό	12



Den Braven

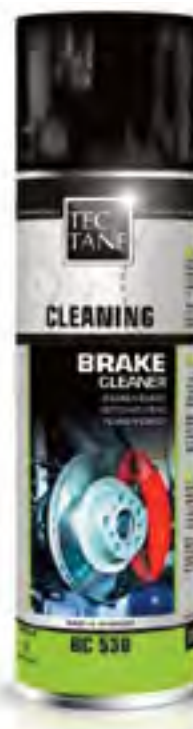

• Δραστικό καθαριστικό φρένων σε σπρέι. Καθαρίζει και βελτιώνει τη λειτουργία των φρένων χωρίς να αφήνει κατάλοιπα. Φιλικό για το χρήστη και το περιβάλλον. Κατάλληλο για όλα τα μέταλλα όπως: σίδηρο, ανοξείδωτο, αλουμίνιο, ασάλι, ντουραλουμίνιο κλπ. Δεν διαβρώνει ούτε καταστρέφει λάστιχα και πλαστικά μέρη με τα οποία θα έρθει σε επαφή. Κατάλληλο για όλους τους τύπους φρένων αλλά και εξαρτήματα σε οχήματα όπως: δισκόφρενα, ταμπούρα, εξαρτήματα φρένων, πλατό συμπλέκτη, αντλίες βενζίνης, αντλίες λαδιού κλπ.

ΣΠΡΕΪ ΦΡΕΝΩΝ 500 ml

09949	καθαριστικό	12



Den Braven



• Καθαριστικό και συντηρητικό σπρέι ηλεκτρικών επαφών με λάδι. Απωθεί το νερό και την υγρασία από ενώσεις καλωδίων. Διαλύει τη βρωμιά που εμφανίζεται σε διακόπτες, φύσες και μπουζί. Σταματά διαρροές, την απώλεια τάσης και προστατεύει από την μακροχρόνια διάβρωση. Βοηθάει στο ξεκίνημα οχημάτων με προβλήματα υγρασίας.
Κατάλληλο για διακόπτες και ηλεκτρικές επαφές οχημάτων, για διανομείς, συνδέσεις καλωδίων, μηχανές, κλαρκ κλπ

ΣΠΡΕΪ ΗΛΕΚΤΡΙΚΩΝ ΕΠΑΦΩΝ 400 ml

09271	καθαριστικό	12



Den Braven



• Το DB Penetrating Oil A-2000 είναι επαγγελματικό αντισκωριακό σπρέι με λάδι με πολύ μεγάλη διεισδυτικότητα. Πολύ δυνατό στη χρήση με γρήγορα αποτελέσματα. Χαλαρώνει κολλημένους συνδέσμους, προσφέροντας μακροχρόνια προστασία από τη διάβρωση. Απελευθερώνει σκουριασμένες αρθρώσεις, παξιμάδια και μπουλόνια, σταματά τριγμούς και θορύβους, λιπαίνει ολισθαίνουσες επιφάνειες.

ΣΠΡΕΪ ΑΝΤΙΣΚΩΡΙΑΚΟ A-2000 400 ml

09947	penetrating oil	12



Den Braven



• Σπρέι που βοηθά το γρήγορο ξεκίνημα μηχανών βενζίνης και πετρελαίου. Βοηθά στην εκκίνηση μηχανών που βρίσκονται σε κρύο περιβάλλον ή έχουν μείνει σε ακινησία για μεγάλο χρονικό διάστημα. Κατάλληλο για αυτοκίνητα, φορτηγά, γεωργικά μηχανήματα, οχήματα ελεύθερου χρόνου, γεννήτριες κλπ. Ιδανικό για περιπτώσεις μηχανών που δεν έχουν συχνή χρήση. Προστατεύει τον κινητήρα και την μπαταρία, εμποδίζει το πάγωμα των καρμπυρατέρ.

ΣΠΡΕΪ ΕΚΚΙΝΗΣΗΣ ΜΗΧΑΝΩΝ 400 ml

09951	engine starter	12



Den Braven



• Το Zwaluw Mixed Finisher Spray είναι έτοιμο προς χρήση υγρό διαμόρφωσης σφραγιστικών υλικών για επαγγελματικό φινιρίσμα. Το υλικό είναι πάνω από 99% βιοδιασπώμενο. Έχει σχεδιαστεί για την μορφοποίηση σφραγιστικών υλικών πριν την ωρίμανσή τους. Ανακινήστε καλά το περιεχόμενο πριν την εφαρμογή. Μετά την εφαρμογή του σφραγιστικού υλικού ψεκάστε την επιφάνεια και τα γύρω σημεία και μορφοποιήστε με μία σπάτουλα μορφοποίησης σφραγιστικών.

ΥΓΡΟ ΔΙΑΜΟΡΦΩΣΗΣ ΣΙΛΙΚΟΝΗΣ

10546	500ml	12



Den Braven



• Το DB Sili-Kill είναι έτοιμη προς χρήση πάστα για την αφαίρεση υπολειμμάτων στεγνής σιλικόνης. Αφαιρούμε με μηχανικά μέσα (μαχαίρι) όσο περισσότερο από την παλιά σιλικόνη και εφαρμόζουμε το υλικό στα υπολείμματα. Μετά από 20-30 λεπτά με μία ξύλινη ή πλαστική σπάτουλα απομακρύνουμε τα υπολείμματα που έχουν μαλακώσει. Εάν χρειαστεί επαναλαμβάνουμε την διαδικασία. Στο τέλος ξεπλένουμε με νερό και σαπούνι και αφήνουμε την επιφάνεια να στεγνώσει.

ΠΑΣΤΑ ΚΑΘΑΡΙΣΜΟΥ ΣΙΛΙΚΟΝΗΣ SILI-KILL

09955	100ml	12



Den Braven



• Πάστα καθαρισμού χεριών με άρωμα λεμόνι. Εξαιρετικά χρήσιμη για την εφαρμοσμένη μηχανική, τα συνεργεία, τη ναυπηγική κ.λπ. Περιέχει ενεργά συστατικά που καθαρίζουν με επιτυχία τις δύσκολες βρωμιές στις οποίες τα κοινά σαπούνια είναι αναποτελεσματικά. Αφήνει τα χέρια μαλακά και με ευχάριστο άρωμα.

ΠΑΣΤΑ ΚΑΘΑΡΙΣΜΟΥ ΧΕΡΙΩΝ

09953	1lt	12
09954	4lt	4



Den Braven



NEW ARRIVAL

• Σμάλτο ακρυλικής βάσης για την επιδιόρθωση χτυπημάτων σε οικιακές συσκευές, κεραμικά πλακάκια και επισμαλτωμένες επιφάνειες. Διαθέτει πινελάκι για ακριβή εφαρμογή και είναι εύχρηστο. Δεν επηρεάζεται από τα καθαριστικά και δεν κιτρινίζει με την πάροδο του χρόνου.

**ΣΜΑΛΤΟ ΕΠΙΔΙΟΡΘΩΣΗΣ ΧΤΥΠΗΜΑΤΩΝ
SMALTO REPAIR**

15416	20ml - λευκό	12



• Αλοιφή σε σωληνάριο που καθαρίζει, επαναφέρει και γυαλίζει όλες τις μεταλλικές επιφάνειες. Προστατεύει από τη διάβρωση και το ξεθώριασμα. Κατάλληλο για αλουμίνιο, χρώμιο, ανοξείδωτο ατσάλι, μπρούτζο, χαλκό, κασίτερο, πλατίνα, ασήμι καθώς επίσης για fiberglass και εστίες μαγειρέματος. Δεν συνίσταται για ανοδιωμένο αλουμίνιο και πολύ λεπτό ασήμι.

ΑΛΟΙΦΗ ΓΥΑΛΙΣΜΑΤΟΣ

10659	75ml	5



INTER



• Γυαλιστικό μετάλλων σε σωληνάριο το οποίο επιφέρει εξαιρετικό καθαριστικό αποτέλεσμα αφαιρώντας τους λεκέδες. Περιέχει ειδική φόρμουλα η οποία δημιουργεί ένα αδιάβροχο φιλμ το οποίο εμποδίζει τη σκουριά και τη διάβρωση για μεγάλο χρονικό διάστημα. Κατάλληλο για αλουμίνιο, χρώμιο, ανοξείδωτο ατσάλι, μπρούτζο, χαλκό.

ΑΛΟΙΦΗ ΓΥΑΛΙΣΜΑΤΟΣ

12024	75ml	24



07170

10991



• Γράσο βάσεως λιθίου με αντιοξειδωτικά και αντιδιαβρωτικά πρόσθετα υψηλών πιέσεων.

Κατάλληλο για εφαρμογές σε έδρανα, γρανάζια και ρουλεμάν. Προδιαγραφές: DIN 51825 KP2(3)K-30, ASTM LB/GB. Θερμοκρασία λειτουργίας: -30°C +125°C.

ΓΡΑΣΟ ΛΙΘΙΟΥ NLGI-3

07170	800gr	12
10991	4kgr	1

**BELLOTA**

• Γράσο γενικής χρήσης για τη λίπανση κάθε είδους μηχανισμού σε πόρτες γκαράζ, μεντεσέδες, μηχανήματα.

Παρουσιάζει μεγάλη πρόσφυση, αντοχή στο νερό και πολύ καλή προστασία κατά της διάβρωσης.

Ιδιαίτερα κατάλληλο για ρουλεμάν που χρησιμοποιούνται σε πολύ υψηλές θερμοκρασίες και φορτία.

ΓΡΑΣΟ ΛΙΘΙΟΥ 6663

05241	150ml - Σωληνάριο	24

**BELLOTA**

• Προδιαγραφή ποιότητας:
ASTM TSC-3, API TC, JASO FB

ΛΑΔΙ ΜΙΞΗΣ ΣΥΝΘΕΤΙΚΟ 3661-2T ΔΙΧΡΟΝΟΥ ΚΙΝΗΤΗΡΑ

07488	1lt	20

**BELLOTA**

ΛΑΔΙ ΑΛΥΣΙΔΑΣ ΑΛΥΣΟΠΡΙΟΝΟΥ 3660

07487	1lt	20



ΛΑΔΙΚΟ

00675	500gr	10

01065 00306

INTER



ΓΡΑΣΑΔΟΡΟΣ ΧΕΙΡΟΣ

01065	200ml	2
00306	400ml	1

PRESSOL



ΓΡΑΣΑΔΟΡΟΣ ΠΑΤΗΤΟΣ ΜΕ ΜΠΕΚ ΑΡΣΕΝΙΚΟ 12322

15639	150 ml	1

PRESSOL



ΓΡΑΣΑΔΟΡΟΣ ΧΕΙΡΟΣ

00307	500ml	1

PRESSOL



ΓΡΑΣΑΔΟΡΟΣ ΠΑΤΗΤΟΣ ΜΕ ΜΠΕΚ ΘΗΛΥΚΟ 12332

15640	150 ml	1





ΓΡΑΣΑΔΟΡΟΣ ΠΑΤΗΤΟΣ

00429	250ml	2

PRESSOL



ΜΑΡΚΟΥΤΣΙ ΓΡΑΣΑΔΟΡΟΥ

02263	Φ8x300mm	5

PRESSOL



ΜΠΕΚ ΓΡΑΣΑΔΟΡΟΥ

02555		5



ΠΙΣΤΟΛΙ ΘΕΡΜΟΚΟΛΛΑΣ

02395	72wat	6



ΚΟΛΛΑ ΘΕΡΜΗΣ ΣΙΛΙΚΟΝΗΣ ΠΟΛΥΧΡΩΜΗ

15226	Φ 7,2mm X 10 cm (σετ 12τμχ)	5



ΚΟΛΛΑ ΘΕΡΜΗΣ ΣΙΛΙΚΟΝΗΣ ΔΙΑΦΑΝΗΣ

15227	Φ 7,2mm X 10 cm (σετ 12τμχ)	5
15228	Φ 11,2mm X 10 cm (σετ 10τμχ)	5



ΠΙΣΤΟΛΙ ΘΕΡΜΟΚΟΛΛΑΣ

10268	80watt	6



ΚΟΛΛΑ ΘΕΡΜΗΣ ΣΙΛΙΚΟΝΗΣ ΔΙΑΦΑΝΗΣ

02772	Φ11,2x300mm	1kgr

ΣΥΡΜΑΤΟΒΟΥΡΤΣΕΣ

ΣΥΡΜΑΤΟΒΟΥΡΤΣΑ

02351 χειρός 24

HOT SELLER

ΣΥΡΜΑΤΟΒΟΥΡΤΣΑ ΤΡΙΧΑ PVC

04585 χειρός 24

ΣΥΡΜΑΤΟΒΟΥΡΤΣΑ ΜΕ ΜΑΚΡΙΑ ΛΑΒΗ

12532 χειρός 24

ΤΟΥΜΠΟΒΟΥΡΤΣΑ

04593	Φ20mm	6
04594	Φ30mm	6
04595	Φ40mm	6
04596	Φ50mm	6
04597	Φ60mm	6
04598	Φ70mm	6
04599	Φ80mm	6
13749	Φ100mm	6

ΠΡΟΕΚΤΑΣΗ ΣΠΙΡΑΛ ΤΟΥΜΠΟΒΟΥΡΤΣΑΣ

10170 1m (295/P) 1

ΠΡΟΕΚΤΑΣΗ ΣΠΙΡΑΛ ΤΟΥΜΠΟΒΟΥΡΤΣΑΣ ΜΕ ΧΕΙΡΟΛΑΒΗ

04601 1,5m (1921) 1



ΣΥΡΜΑΤΟΒΟΥΡΤΣΑ ΧΟΥΦΤΑΣ

06067	No8	12



09351



09352

INTER



ΣΥΡΜΑΤΟΒΟΥΡΤΣΑ ΠΙΝΕΛΟ ΔΡΑΠΑΝΟΥ

09351	Φ17mm	20
09352	Φ25mm	20



02117



06974



ΣΥΡΜΑΤΟΒΟΥΡΤΣΑ ΚΟΥΠΑ ΔΡΑΠΑΝΟΥ

02117	Φ85mm	8
06974	Φ100mm	5



00093



00094



ΑΚΟΝΙΑ

00093	μικρό 6"	5
00094	μεγάλο 8"	5



06620

06622



06621

06623



00159



ΑΚΟΝΙΑ ΠΕΤΡΑ ΚΡΗΤΗΣ ΝΕΡΟΥ

06620	0,2-0,5kgr	kgr
06621	0,5-1,0kgr	kgr
00159	1,0-1,5kgr	kgr
06622	1,5-2,0kgr	kgr
06623	2,5-5,0kgr	kgr



ΑΚΟΝΙΣΤΗΡΙ SHARP-X



05017

5



ΑΚΟΝΙΣΤΗΡΙ ΤΑΪΒΑΝ



08744

10



09664



09666



09665



09667



HOT SELLER

GET IT NOW

• Δίσκος γενικής χρήσης, κατάλληλος για λείανση όλων των τύπων μετάλλων, ιδιαίτερα κατάλληλος για χάλυβα κατασκευών και ραφές συγκόλλησης.

ΤΡΟΧΟΣ ΛΕΙΑΝΣΗΣ A 30 T PERFECT



09664

115x22,2x6,0mm (Φ x οπή x πάχος)

10

09665

125x22,2x6,0mm (Φ x οπή x πάχος)

10

09666

180x22,2x6,0mm (Φ x οπή x πάχος)

10

09667

230x22,2x6,0mm (Φ x οπή x πάχος)

10

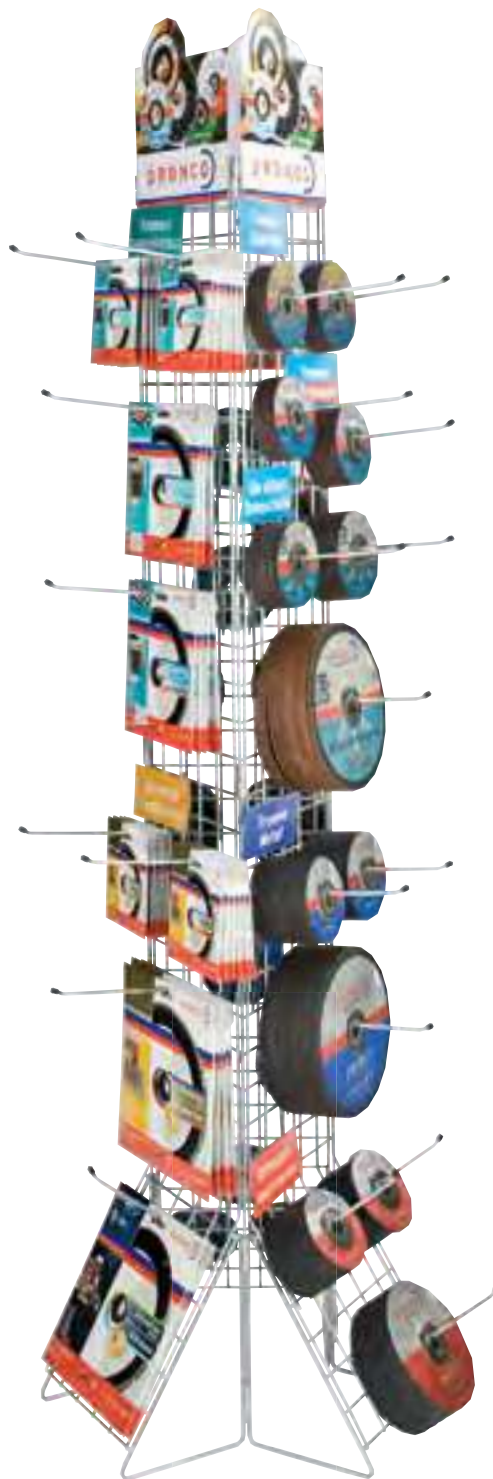

ΕΚΘΕΤΗΡΙΟ ΤΡΟΧΩΝ



09671

3 σταυτ - 26x175mm

1

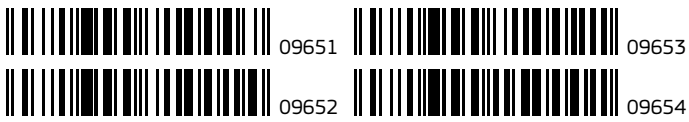

09651

09653



09652

09654



• Δίσκος γενικής χρήσης, κατάλληλος για κοπή διαφόρων μετάλλων. Πολύ καλή διάρκεια ζωής, γρήγορο κόψιμο.

ΤΡΟΧΟΣ ΚΟΠΗΣ ΣΙΔΗΡΟΥ A 24 R PERFECT

Barcode	Icon	Icon
09651	115x22,2x3,0mm (Φ x οπή x πάχος)	25
09652	125x22,2x3,0mm (Φ x οπή x πάχος)	25
09653	180x22,2x3,0mm (Φ x οπή x πάχος)	25
09654	230x22,2x3,0mm (Φ x οπή x πάχος)	25



15347

15348



NEW ARRIVAL

• Δίσκος πολύ καλής ποιότητας για τη κοπή μετάλλων, κατάλληλος για βιοτέχνες και βιομηχανικές εφαρμογές. Προσφέρει βελτιστοποιημένη απόδοση, μεγάλη διάρκεια ζωής και μείωση του χρόνου κοπής.

ΤΡΟΧΟΣ ΚΟΠΗΣ ΣΙΔΗΡΟΥ AS36T SUPERIOR

Barcode	Icon	Icon
15347	300x25,4x2,8mm (Φ x οπή x πάχος)	10
15348	350x25,4x2,8mm (Φ x οπή x πάχος)	10



09655

09656



• Δίσκος λεπτός (1,0mm) κατάλληλος για κοπή μετάλλων και inox, ιδιαίτερα κατάλληλος για προφίλ με λεπτό τοίχωμα και φύλλα μετάλλων σε εργασίες δομικών έργων. Χρησιμοποιείται πολύ συχνά στη φανοποιεία. Οικονομική εναλλακτική λύση για αποτελεσματική και γρήγορη κοπή.

ΤΡΟΧΟΣ ΚΟΠΗΣ ΙΝΟΧ A 60 R PERFECT

Barcode	Icon	Icon
09655	115x22,2x1,0mm (Φ x οπή x πάχος)	25
09656	125x22,2x1,0mm (Φ x οπή x πάχος)	25





10576



10578



10577



• Δίσκος κοπής κατάλληλος για κοπή μετάλλων και inox, ιδιαίτερα κατάλληλος για λεπτά μεταλλικά φύλλα, προφίλ και σωλήνες.
Εξαιρετική ποιότητα, καθαρή κόψη, ταχύτητα κοπής, ακρίβεια, μεγάλη διάρκεια ζωής και ελάχιστη κατανάλωση ενέργειας.

ΤΡΟΧΟΣ ΚΟΠΗΣ ΙΝΟΧ EVOLUTION

Barcode	Icon	Code	Quantity
10576		115x22,2x1,0mm (Φ x οπή x πάχος) - code: AS60V	25
10577		125x22,2x1,0mm (Φ x οπή x πάχος) - code: AS60V	25
10578		125x22,2x1,9mm (Φ x οπή x πάχος) - code: AS46V	25



NEW ARRIVAL

GET IT NOW



15318



15319



• Δίσκος κοπής κατάλληλος για κοπή μετάλλων και inox, ιδιαίτερα κατάλληλος για λεπτά μεταλλικά φύλλα, προφίλ και σωλήνες.
Εξαιρετική ποιότητα, καθαρή κόψη, ταχύτητα κοπής, ακρίβεια, μεγάλη διάρκεια ζωής και ελάχιστη κατανάλωση ενέργειας.

ΔΙΑΤΙΘΕΤΑΙ ΣΕ ΜΕΤΑΛΛΙΚΟ ΚΟΥΤΙ περιεχόμενο 10 τεμαχίων

ΤΡΟΧΟΣ ΚΟΠΗΣ ΙΝΟΧ EVOLUTION

Barcode	Icon	Code	Quantity
15318		115x22,2x1,0mm (Φ x οπή x πάχος) - code: AS60V	1
15319		125x22,2x1,0mm (Φ x οπή x πάχος) - code: AS60V	1



NEW ARRIVAL



12141



09744



12142



09745



• Δίσκος λεπτός πολύ καλής ποιότητας για τη κοπή μετάλλων και inox, κατάλληλος για φύλλα μετάλλων και λεπτού τοιχώματος προφίλ. Ιδιαίτερα κατάλληλος για τη βιομηχανία κατασκευής δεξαμενών.
Δεν περιέχει σίδηρο και θείο, έχει υψηλή ταχύτητα κοπής, μακρά διάρκεια ζωής και απαιτεί ελάχιστη προσπάθεια από το χρήστη.

ΤΡΟΧΟΣ ΚΟΠΗΣ ΙΝΟΧ SUPERIOR

Barcode	Icon	Code	Quantity
12141		115x22,2x1,0mm (Φ x οπή x πάχος) - code: AS60T	25
12142		125x22,2x1,0mm (Φ x οπή x πάχος) - code: AS60T	25
09744		180x22,2x1,6mm (Φ x οπή x πάχος) - code: AS46T	25
09745		230x22,2x1,9mm (Φ x οπή x πάχος) - code: AS46T	25



NEW ARRIVAL

GET IT NOW



12707



12708

osborn

• Δίσκος λεπτός πολύ καλής ποιότητας κατάλληλος για κοπή μετάλλων και inox, ιδιαίτερα κατάλληλος για φύλλα μετάλλων και λεπτού τοιχώματος προφίλ. Ιδιαίτερα κατάλληλος για τη βιομηχανία κατασκευής δεξαμενών και τη φανοποιεία. Επιτρέπει την επίτευξη καθαρής τομής, σε ελάχιστο χρόνο, χωρίς κραδασμούς και με ελάχιστη δύναμη από το χρήστη.

ΔΙΑΤΙΘΕΤΑΙ ΣΕ ΜΕΤΑΛΛΙΚΟ ΚΟΥΤΙ περιεχόμενο 10 τεμαχίων

ΤΡΟΧΟΣ ΚΟΠΗΣ ΙΝΟΧ AS60T SUPERIOR

Barcode	Dimensions (Φ x οπή x πάχος)	Quantity
12707	115x22,2x1,2mm (Φ x οπή x πάχος)	1
12708	125x22,2x1,2mm (Φ x οπή x πάχος)	1



NEW ARRIVAL



13680



13682



13681

osborn

• Δίσκος λεπτός πολύ καλής ποιότητας κατάλληλος για κοπή μετάλλων και inox, ιδιαίτερα κατάλληλος για φύλλα μετάλλων και λεπτού τοιχώματος προφίλ. Ιδιαίτερα κατάλληλος για τη βιομηχανία κατασκευής αμαξωμάτων. Η οικονομική εναλλακτική λύση για λεπτούς δίσκους κοπής χάλυβα. Πολύ καλό αποτέλεσμα κοπής με καλή διάρκεια ζωής.

ΤΡΟΧΟΣ ΚΟΠΗΣ ΙΝΟΧ ATTACK

Barcode	Dimensions (Φ x οπή x πάχος) - code:	Quantity
13680	115x22,2x1,0mm (Φ x οπή x πάχος) - code: A60R	25
13681	125x22,2x1,0mm (Φ x οπή x πάχος) - code: A60R	25
13682	230x22,2x1,9mm (Φ x οπή x πάχος) - code: A46R	25



NEW ARRIVAL



12709



12710

osborn

• Δίσκος ειδικά σχεδιασμένος για να κόβει αλουμίνιο και μη σιδηρούχα μέταλλα όπως χαλκό, ορείχαλκο, χαλκό. Επίσης κατάλληλος για τα περισσότερα συνθετικά υλικά. Τα εξαιρετικά χαρακτηριστικά των λεπτών δίσκων κοπής είναι τώρα διαθέσιμα για το αλουμίνιο και τα μη σιδηρούχα μέταλλα επίσης. Γρήγορη κοπή χωρίς φράξιμο, μεγάλη διάρκεια ζωής.

ΤΡΟΧΟΣ ΚΟΠΗΣ ΑΛΟΥΜΙΝΙΟΥ CS 60 ALU SUPERIOR

Barcode	Dimensions (Φ x οπή x πάχος)	Quantity
12709	115x22,2x1,2mm (Φ x οπή x πάχος)	25
12710	125x22,2x1,2mm (Φ x οπή x πάχος)	25



NEW ARRIVAL



13493



13494

osborn

• Δίσκος για χρήση σε ανοξείδωτο χάλυβα, μαλακό χάλυβα, πέτρα, πλακίδια τοίχου. Η ειδική σύσταση αυτού του νέου combi-δίσκου επιτρέπει την κοπή πλακιδίων και μετάλλων χωρίς αλλαγή δίσκου. Καλή απόδοση, άνετη, γρήγορη και καθαρή κοπή.

ΤΡΟΧΟΣ ΚΟΠΗΣ ΠΟΛΛΑΠΛΩΝ ΕΦΑΡΜΟΓΩΝ ACS 60 T MULTI SUPERIOR

Barcode	Product Code	Dimensions (Φ x οπή x πάχος)	Quantity
	13493	115x22,2x1,2mm (Φ x οπή x πάχος)	25
	13494	125x22,2x1,2mm (Φ x οπή x πάχος)	25



**NEW
ARRIVAL**



09657



09659



09658



09660

osborn

• Δίσκος για τη κοπή δομικών υλικών όπως σκυρόδεμα, πέτρα, κεραμίδια, ασβεστολιθική πέτρα. Μεγάλη διάρκεια ζωής και γρήγορη κοπή σε λογική τιμή.

ΤΡΟΧΟΣ ΚΟΠΗΣ ΜΑΡΜΑΡΟΥ C 24 R PERFECT

Barcode	Product Code	Dimensions (Φ x οπή x πάχος)	Quantity
	09657	115x22,2x3,0mm (Φ x οπή x πάχος)	25
	09658	125x22,2x3,0mm (Φ x οπή x πάχος)	25
	09659	180x22,2x3,0mm (Φ x οπή x πάχος)	25
	09660	230x22,2x3,0mm (Φ x οπή x πάχος)	25



**NEW
ARRIVAL**



09661



09663

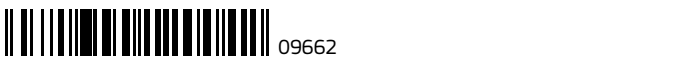

09662

osborn

• Δίσκος για την κοπή πέτρας, πλακών, πλακιδίων διαπέδου, πλακιδίων τοίχου, μαρμάρου κλπ. Απίστευτα γρήγορη και καθαρή κοπή. Άνετη χρήση λόγω μειωμένης απόδοσης θορύβου και κραδασμών. Μέχρι και 50% λιγότερη λειαντική σκόνη κατά την κοπή.

ΤΡΟΧΟΣ ΚΟΠΗΣ ΜΑΡΜΑΡΟΥ ΨΙΛΟΣ PERFECT

Barcode	Product Code	Dimensions (Φ x οπή x πάχος) - code:	Quantity
	09661	115x22,2x1,2mm (Φ x οπή x πάχος) - code: C60R	25
	09662	125x22,2x1,2mm (Φ x οπή x πάχος) - code: C60R	25
	09663	230x22,2x1,9mm (Φ x οπή x πάχος) - code: C46R	25



**NEW
ARRIVAL**

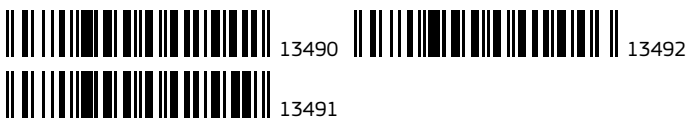

• Διαμαντόδισκος με ειδική λεπίδα για σκληρές φυσικές πέτρες όπως γρανίτη, σχιστόλιθο, κλίνκερ, και πορφυρόλιθο. Κοπτικά τμήματα υψηλής απόδοσης, συγκόλλησης με λέιζερ, για την εύκολη κοπή φυσικών λίθων. Άνετη κοπή και μεγάλη διάρκεια ζωής.

ΔΙΣΚΟΣ ΔΙΑΜΑΝΤΕ SUPERIOR G4

Barcode	Product Name	Quantity
13490	115x22,2x2,0mm (Φ x οπή x πάχος)	1
13491	125x22,2x2,0mm (Φ x οπή x πάχος)	1
13492	230x22,2x2,4mm (Φ x οπή x πάχος)	1

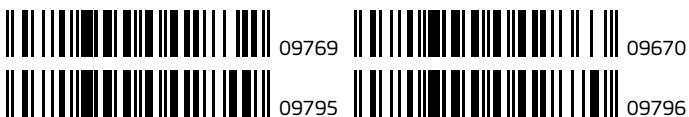

• Διαμαντόδισκος κοπής κατάλληλος για δομικά υλικά όπως: σκυρόδεμα, εκτεθειμένο αδρανές σκυρόδεμα, τούβλα. Συγκόλληση με λέιζερ, λεπίδα που έχει σχεδιαστεί για να κόβει τα δομικά υλικά στεγνά ή υγρά. Μέγιστη ασφάλεια και πολύ καλά αποτελέσματα κοπής σε λογική τιμή.

ΔΙΣΚΟΣ ΔΙΑΜΑΝΤΕ SUPERIOR U4

Barcode	Product Name	Quantity
09769	115x22,2x2,2mm (Φ x οπή x πάχος)	1
09795	125x22,2x2,2mm (Φ x οπή x πάχος)	1
09670	180x22,2x2,4mm (Φ x οπή x πάχος)	1
09796	230x22,2x2,4mm (Φ x οπή x πάχος)	1



• Διαμαντόδισκος κατάλληλος για τη κοπή πλακιδίων τοίχου, πλακιδίων δαπέδου, κεραμιδιών. Λεπίδα κοπής συνεχούς στεφάνης για καθαρό και γρήγορο κόψιμο.

ΔΙΣΚΟΣ ΔΙΑΜΑΝΤΕ PERFECT F3

Barcode	Product Name	Quantity
09797	115x22,2x2,0mm (Φ x οπή x πάχος)	1
09770	125x22,2x2,0mm (Φ x οπή x πάχος)	1



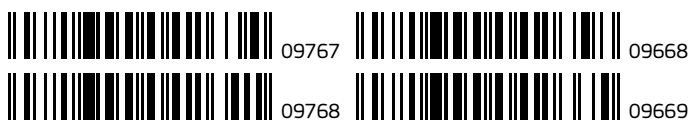

• Διαμαντόδισκος κατάλληλος για κοπή σε σκυρόδεμα, πλακάκια σκυροδέματος, πυρίμακες πέτρες, γρανίτη, τούβλα.
Λεπίδα συνεχούς στεφάνης που παράγει καθαρή τομή χωρίς σπασίματα.
Το βάθος κοπής δεν πρέπει να υπερβαίνει τα 2cm.

ΔΙΣΚΟΣ ΔΙΑΜΑΝΤΕ PERFECT S3 TURBO

Barcode	Product Name	Quantity
09767	115x22,2x2,1mm (Φ x οπή x πάχος)	1
09768	125x22,2x2,1mm (Φ x οπή x πάχος)	1
09668	180x22,2x2,6mm (Φ x οπή x πάχος)	1
09669	230x22,2x2,8mm (Φ x οπή x πάχος)	1



• Λεπτός δίσκος κοπής υψηλών επιδόσεων με σταφάνι κοπής turbo. Ιδανικός για κοπή κεραμικών, πλακιδίων, σκληρής πέτρας και γρανίτη. Εξαιρετική ταχύτητα κοπής, μεγάλη διάρκεια ζωής, καθαρή κοπή.

ΔΙΣΚΟΣ ΔΙΑΜΑΝΤΕ SUPERIOR F4 CERA SPEED

Barcode	Product Name	Quantity
15320	115x22,2x1,4mm (Φ x οπή x πάχος)	1
15321	125x22,2x1,4mm (Φ x οπή x πάχος)	1



NEW
ARRIVAL



• Διαμαντόδισκος κατάλληλος για την κοπή πλακιδίων, πλακών από πέτρα και γρανίτη. Χάρη στο πάχος του μόλις 1,2 mm και την ειδική γεωμετρία του συνεχούς χείλους, εξασφαλίζει τόσο εξαιρετική ταχύτητα κοπής όσο και άνετη και ομαλή λειτουργία.
Προσφέρει ασφάλεια λειτουργίας, μέγιστη διάρκεια ζωής, ευκολία στη χρήση, και καθαρή κοπή.

ΔΙΣΚΟΣ ΔΙΑΜΑΝΤΕ EVOLUTION F5 CERA SPEED

Barcode	Product Name	Quantity
13482	115x22,2x1,2mm (Φ x οπή x πάχος)	1
13483	125x22,2x1,2mm (Φ x οπή x πάχος)	1





smirdex



ΕΚΘΕΤΗΡΙΟ ΔΙΠΛΗΣ ΟΨΗΣ

04973 διαστάσεις (Π x Β x Υ): 80x30x200cm 1



smirdex



ΕΚΘΕΤΗΡΙΟ ΜΟΝΗΣ ΟΨΗΣ

13976 διαστάσεις (Π x Β x Υ): 100x36x200cm 1

ΚΕΡΑΜΙΚΟ ΔΙΧΤΥ ΠΟΥ ΠΡΟΣΦΕΡΕΙ ΤΕΛΕΙΟ ΤΡΙΨΙΜΟ ΧΩΡΙΣ ΣΚΟΝΗ

Η δομή του δικτύου επιτρέπει τη μέγιστη απορρόφηση της σκόνης κατά το τρίψιμο παρέχοντας έτσι καθαρότερες επιφάνειες επεξεργασίας. Αυτό συμβάλλει σε ένα υγιές περιβάλλον εργασίας, όπου απαιτείται λιγότερος χρόνος και προσπάθεια για τον καθαρισμό του, ενώ ο εργαζόμενος προστατεύεται από την επικίνδυνη σκόνη που δημιουργείται.

Το SMIRDEX CERAMIC NET προσφέρει καλύτερη παραγωγικότητα και κερδοφορία αφού ελαχιστοποιείται το μπουκώμα, προσφέροντας έτσι τη δυνατότητα για υψηλότερες επιδόσεις.

Χάρη στους κεραμικούς κόκκους που περιέχει, το δίχτυ Smirdex είναι ιδανικό για πιο δύσκολες και απαιτητικές εφαρμογές, όπως σκληρό ξύλο, σκληρούς στόκους και άλλα σιβαρά υλικά. Προσφέρει επίσης μια εξαιρετική απόδοση και διάρκεια ζωής για τρίψιμο σε αστάρι.

Εφαρμογές: Φανοποιία Επιπλοποιία

Η δομή του πλέγματος επιτρέπει τη μέγιστη απορρόφηση της σκόνης κατά το τρίψιμο και δεν αφήνει τον δίσκο να μπουκώσει.

	14853		12451
	12446		12452
	12447		12453
	12448		12454
	12449		12455
	12450		

smirdex



**VELCRO CERAMIC NET 750
Φ125 mm ΧΩΡΙΣ ΤΡΥΠΕΣ**

14853	P60	50
12446	P80	50
12447	P100	50
12448	P120	50
12449	P150	50
12450	P180	50
12451	P220	50
12452	P240	50
12453	P320	50
12454	P400	50
12455	P500	50

	14854		12405
	12400		12406
	12401		12407
	12402		12408
	12403		12409
	12404		

smirdex



**VELCRO CERAMIC NET 750
Φ150mm ΧΩΡΙΣ ΤΡΥΠΕΣ**

14854	P60	50
12400	P80	50
12401	P100	50
12402	P120	50
12403	P150	50
12404	P180	50
12405	P220	50
12406	P240	50
12407	P320	50
12408	P400	50
12409	P500	50



	14856		12414
	12999		12415
	12410		12416
	12411		12614
	12412		12731
	12413		12701

smirdex

NEW ARRIVAL



VELCRO CERAMIC NET 750 ΡΟΛΟ 25 m

14856	115mm - P60	25
12999	70mm - P80	25
12410	115mm - P80	25
12411	115mm - P100	25
12412	115mm - P120	25
12413	115mm - P150	25
12414	115mm - P180	25
12415	115mm - P220	25
12416	115mm - P240	25
12614	115mm - P320	25
12731	115mm - P400	25
12701	115mm - P500	25

	15307		14389
	14387		14390
	14388		

NEW ARRIVAL

smirdex

ΥΨΗΛΗ ΑΠΟΔΟΣΗ ΓΙΑ ΣΚΛΗΡΕΣ ΔΟΥΛΕΙΕΣ!

Οι νέοι κεραμικοί δίσκοι 740 προσφέρουν βελτιωμένες επιδόσεις που διαρκούν πολύ περισσότερο από ό, τι τα συμβατικά λειαντικά. Η επίστρωση στεατικού τσίγκου αποτρέπει την συσσώρευση σκόνης και το μπουκώμα του δίσκου, επεκτείνοντας έτσι τη διάρκεια ζωής του προϊόντος.

Ο κεραμικός κόκκος που χρησιμοποιείται έχει αιχμηρές άκρες, που απομακρύνονται σταδιακά κατά την τριβή παρέχοντας έτσι μεγάλη διάρκεια ζωής και καλύτερο φινίρισμα. Οι κεραμικοί δίσκοι είναι ιδανικοί για λείανση οποιουδήποτε τύπου υλικού, συμπεριλαμβανομένων των βερνικιών που είναι ανθεκτικά στις γρατσουνιές (antiscratch technology), τα αστάρια και συνθετικά (composites) εξαλείφοντας την ανάγκη για ειδικά προϊόντα. Τα δισκάκια αυτά μπορούν να δεχθούν υψηλές πιέσεις κατά την χρήση, κάνοντας έτσι εύκολο το τρίψιμο αφού προσδίδουν υψηλά ποσοστά απομάκρυνσης υλικού από την επιφάνεια επεξεργασίας. Τέλος, η βέλτιστη απορρόφηση μέσω των 15 τρυπών συμβάλλει σε ένα περιβάλλον χωρίς σκόνη, προστατεύοντας τον εργαζόμενο από την σκόνη.

Εφαρμογές: Φανοποιία Ναυπηγεία

Ο κεραμικός κόκκος έχει αιχμηρές άκρες, που απομακρύνονται σταδιακά κατά την τριβή, παρέχοντας έτσι μεγάλη διάρκεια ζωής και καλύτερο φινίρισμα.



VELCRO CERAMIC NET 740 Φ115mm ΡΟΛΟ 25 m

15307	P40	25
14387	P220	25
14388	P320	25
14389	P400	25
14390	P600	25

	13510		13514
	13511		13515
	13512		13516
	13513		

smirdex

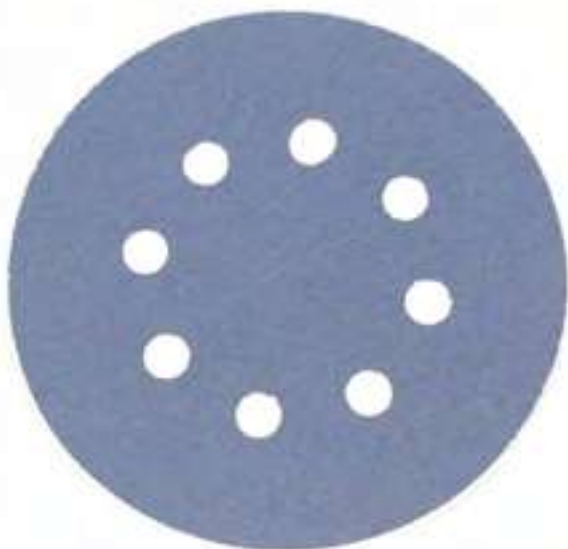

VELCRO CERAMIC LINE 740 Φ125 mm 8 ΤΡΥΠΕΣ

13510	P40	50
13511	P60	50
13512	P80	100
13513	P100	100
13514	P120	100
13515	P150	100
13516	P180	100

	13789		13796
	13790		13797
	13791		13798
	13792		13887
	13793		14527
	13794		14380
	13795		14381

smirdex

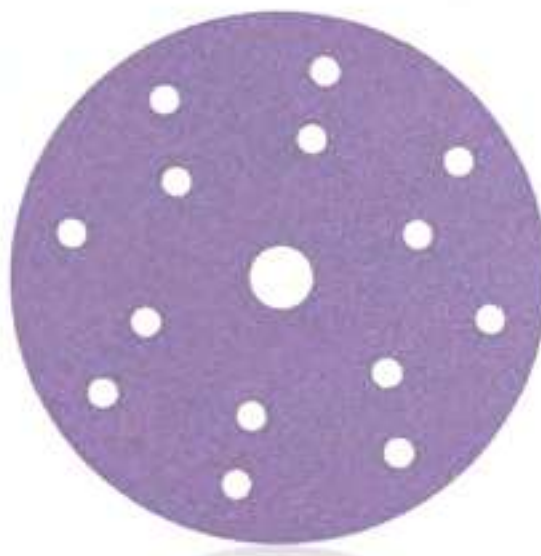

VELCRO CERAMIC LINE 740 Φ150 mm 15 ΤΡΥΠΕΣ

13789	P40	50
13790	P60	50
13791	P80	100
13792	P100	100
13793	P120	100
13794	P150	100
13795	P180	100
13796	P220	100
13797	P240	100
13798	P320	100
13887	P400	100
14527	P600	100
14380	P800	100
14381	P1000	100



ΙΔΑΝΙΚΗ ΓΙΑ ΣΚΑΦΗ & ΑΥΤΟΚΙΝΗΤΑ!

Η σειρά 820 αποτελεί το ιδανικό λειαντικό στην βιομηχανία αυτοκινήτου και θαλάσσιων σκαφών.

Είναι κατάλληλη για επιφάνειες ασαριού, στόκου, βερνικιού. Επίσης είναι ιδανική για την λείανση ξύλινων επιφανειών. Η ανοικτή δομή των ειδικών κόκκων και η επιπλέον στεατική επιστρώση αυξάνουν την διάρκεια απόδοσης και αποτρέπουν το γρήγορο μπούκωμα του γυαλόχαρτου.

Οι ειδικής επεξεργασίας κόκκοι Οξειδίου του Αλουμινίου προσδίδουν πολύ γρήγορα αποτελέσματα λείανσης και υψηλές αποδόσεις.

Εφαρμογές: Φανοποιία Ναυπηγεία Επιπλοποιία

	11908		11915
	11909		11916
	11910		11917
	11911		11918
	11912		12789
	11913		12699
	11914		12790

smirdex

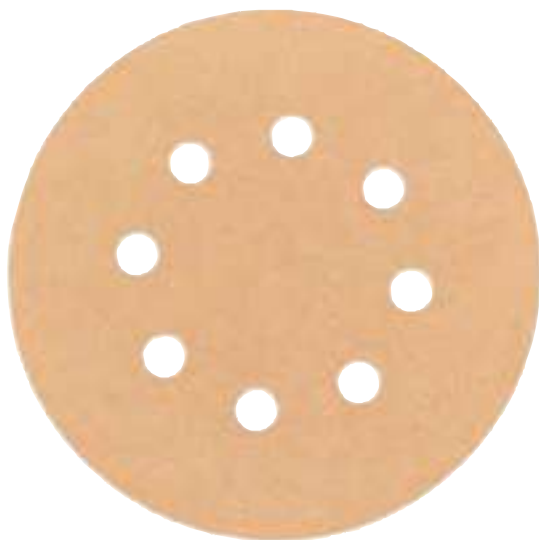

VELCRO YELLOW LINE 820 Φ125 mm 8 ΤΡΥΠΕΣ

11908	P40	50
11909	P60	50
11910	P80	100
11911	P100	100
11912	P120	100
11913	P150	100
11914	P180	100
11915	P220	100
11916	P240	100
11917	P320	100
11918	P400	100
12789	P600	100
12699	P800	100
12790	P1000	100

	11919		11926
	11920		11927
	11921		11928
	11922		12333
	11923		12791
	11924		12792
	11925		12793

smirdex



VELCRO YELLOW LINE 820 Φ150 mm 8+1 ΤΡΥΠΕΣ

11919	P40	50
11920	P60	50
11921	P80	100
11922	P100	100
11923	P120	100
11924	P150	100
11925	P180	100
11926	P220	100
11927	P240	100
11928	P320	100
12333	P400	100
12791	P600	100
12792	P800	100
12793	P1000	100

	14823		14832
	14824		14833
	14825		14834
	14826		14835
	14827		14836
	14828		14837
	14829		14838
	14830		14839
	14831		

smirdex

NEW
ARRIVAL



VELCRO YELLOW LINE 820 Φ150 mm 17 ΤΡΥΠΕΣ

14823	P40	50
14824	P60	50
14825	P80	100
14826	P100	100
14827	P120	100
14828	P150	100
14829	P180	100
14830	P220	100
14831	P240	100
14832	P280	100
14833	P320	100
14834	P360	100
14835	P400	100
14836	P500	100
14837	P600	100
14838	P800	100
14839	P1000	100

	13299		13304
	13300		13305
	13301		13306
	13302		13307
	13303		13308

smirdex



ΣΜΥΡΙΔΟΧΑΡΤΟ YELLOW LINE 820 ΦΥΛΛΟ 230x280 mm

13299	P60	50
13300	P80	50
13301	P100	50
13302	P120	50
13303	P150	50
13304	P180	50
13305	P220	50
13306	P240	50
13307	P280	50
13308	P320	50



03126	03888	06932	05572
03123	12392	06933	04338
03124	03889	05243	
03125	03890	06934	
03127	05242	06935	
02230	06930	06936	
06929	06931	06178	

smirdex

ΙΔΑΝΙΚΗ ΓΙΑ ΕΠΙΦΑΝΕΙΕΣ ΜΕ ΣΤΟΚΟ, ΑΣΤΑΡΙ, ΒΕΡΝΙΚΙ!

• Η σειρά 510 προτείνεται για την λείανση επιφανειών αυτοκινήτου και θαλάσσιων σκαφών. Είναι ιδανική για την τριβή επιφανειών με στόκο, αστάρι, βερνίκι. Επίσης προτείνεται και για την λείανση ξύλινων επιφανειών.

Η ανοικτή δομή κατανομής των κόκκων και η επιπλέον στεατική επίστρωση αποτρέπει το γρήγορο μπουκωμα του γυαλόχαρτου και αυξάνει την διάρκεια ζωής του.

Η σειρά 510 προτείνεται επίσης και για την οικοδομή και ειδικότερα για την τριβή γυψοσανίδων και σπατουλαριστών.

Εφαρμογές: Φανοποιία, Ναυπηγεία, Επιπλοποιία, Οικοδομή



VELCRO ΛΕΥΚΟ (510) Φ125mm ΧΩΡΙΣ ΤΡΥΠΕΣ

03126	P40	50
03123	P60	50
03124	P80	100
03125	P100	100
03127	P120	100
02230	P150	100
06929	P180	100
03888	P220	100
12392	P240	100
03889	P320	100
03890	P400	100

VELCRO ΛΕΥΚΟ (510) Φ150mm ΧΩΡΙΣ ΤΡΥΠΕΣ

05242	P40	50
06930	P60	50
06931	P80	100
06932	P100	100
06933	P120	100
05243	P150	100
06934	P180	100
06935	P220	100
06936	P240	100
06178	P320	100

VELCRO ΛΕΥΚΟ (510) Φ203mm ΧΩΡΙΣ ΤΡΥΠΕΣ

05572	P150	100
04338	P180	100

	03462		05850
	03463		05851
	03464		06016
	03465		06625
	03466		06681
	04320		06626
	04321		06403
	04322		
	03749		

smirdex

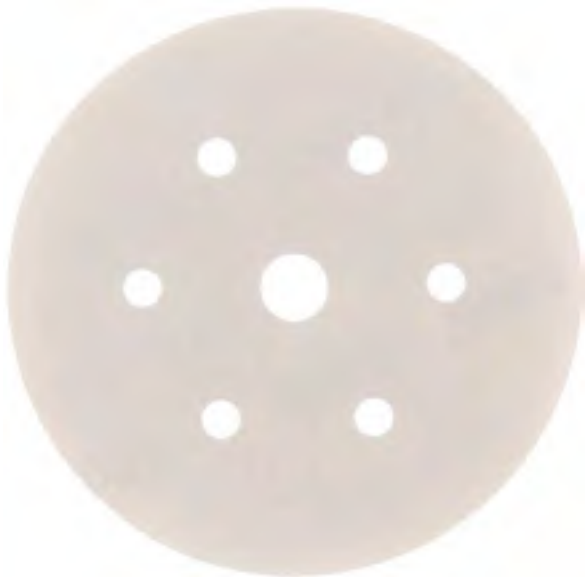

**VELCRO ΛΕΥΚΟ (510) Φ150mm
6+1 ΤΡΥΠΕΣ**

03462	P40	50
03463	P60	50
03464	P80	100
03465	P100	100
03466	P120	100
04320	P150	100
04321	P180	100
04322	P220	100
03749	P240	100
05850	P280	100
05851	P320	100
06016	P360	100
06625	P400	100
06681	P500	100
06626	P600	100
06403	P800	100

	03908		07356
	03909		07357
	03910		12255
	03911		05263
	04323		13646
	04845		13647
	04846		13648
	04847		
	05261		

smirdex



**VELCRO ΛΕΥΚΟ (510) Φ125mm
8 ΤΡΥΠΕΣ**

03908	P40	50
03909	P60	50
03910	P80	100
03911	P100	100
04323	P120	100
04845	P150	100
04846	P180	100
04847	P220	100
05261	P240	100
07356	P280	100
07357	P320	100
12255	P360	100
05263	P400	100
13646	P500	100
13647	P600	100
13648	P800	100



	07067		00445
	05383		12253
	03157		05384
	05582		12254
	05583		05385
	00132		12489
	07031		13587
	13074		

smirdex



VELCRO ΛΕΥΚΟ (510) Φ150mm 8+1 ΤΡΥΠΕΣ

07067	P40	50
05383	P60	50
03157	P80	100
05582	P100	100
05583	P120	100
00132	P150	100
07031	P180	100
13074	P220	100
00445	P240	100
12253	P280	100
05384	P320	100
12254	P360	100
05385	P400	100
12489	P500	100
13587	P600	100

	12373		12380
	12374		12381
	12375		12382
	12376		12383
	12377		14393
	12378		14394
	12379		

smirdex



VELCRO ΛΕΥΚΟ (510) Φ150mm 15 ΤΡΥΠΕΣ

12373	P40	50
12374	P60	50
12375	P80	100
12376	P100	100
12377	P120	100
12378	P150	100
12379	P180	100
12380	P220	100
12381	P240	100
12382	P280	100
12383	P320	100
14393	P400	100
14394	P600	100



smirdex



VELCRO ΛΕΥΚΟ (510) 93X185mm 8 ΤΡΥΠΕΣ

Barcode	Product Code	Quantity
06758	P40	50
06759	P 60	50
06232	P 80	50
06233	P100	50
06234	P120	50
05349	P150	50
05350	P180	50
05351	P220	50
05352	P240	50
05353	P320	50
05354	P400	50
05355	P500	50



smirdex



VELCRO ΛΕΥΚΟ (510) 115X230mm ΧΩΡΙΣ ΤΡΥΠΕΣ

Barcode	Product Code	Quantity
05836	P40	50
05837	P60	50
05838	P80	50
05839	P100	50
14819	P120	50
04936	P150	50
04937	P180	50
04938	P220	50
04940	P240	50
04939	P320	50

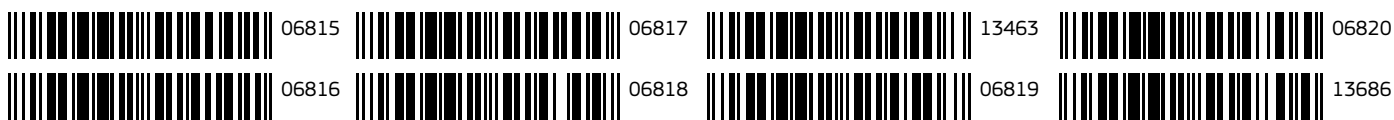

smirdex

VELCRO ΛΕΥΚΟ (510) 115X230mm 10 ΤΡΥΠΕΣ

Barcode	Code	Quantity
06815	P 60	50
06816	P 80	50
06817	P100	50
06818	P120	50
13463	P150	50
06819	P180	50
06820	P240	50
13686	P320	50

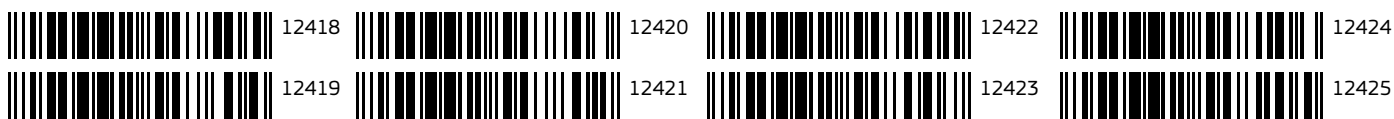

smirdex

VELCRO ΛΕΥΚΟ ΤΡΙΓΩΝΟ (510) 95X95X95mm 6 ΤΡΥΠΕΣ

Barcode	Code	Quantity
12418	P40	50
12419	P60	50
12420	P80	100
12421	P100	100
12422	P120	100
12423	P150	100
12424	P180	100
12425	P220	100
12426	P240	100

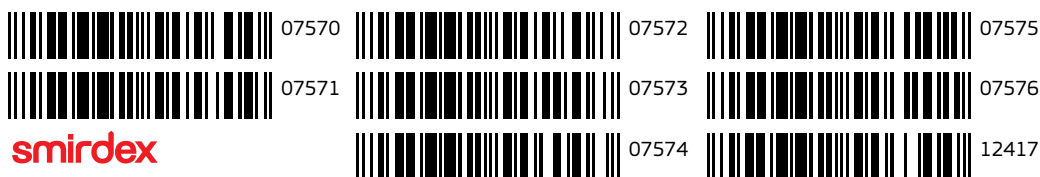

smirdex

VELCRO ΛΕΥΚΟ ΤΡΙΓΩΝΟ (510) 100X147X147MM 7 ΤΡΥΠΕΣ

Barcode	Code	Quantity
07570	P40	50
07571	P60	50
07572	P80	100
07573	P100	100
07574	P120	100
07575	P150	100
07576	P180	100
12417	P220	100
15223	P320	100



	11941		11948
	11942		11949
	11943		11950
	11944		11951
	11945		14006
	11946		14007
	11947		14008

smirdex



ΣΜΥΡΙΔΟΧΑΡΤΟ (510) ΦΥΛΛΟ 230X280mm

11941	P40	50
11942	P60	50
11943	P80	50
11944	P100	50
11945	P120	50
11946	P150	50
11947	P180	50
11948	P220	50
11949	P240	50
11950	P320	50
11951	P400	50
14006	P500	50
14007	P600	50
14008	P800	50

	11952		11956
	11953		11957
	11954		
	11955		

smirdex



ΦΥΛΛΟ ΡΑΣΠΑ VELCRO (510) 70X420mm ΧΩΡΙΣ ΤΡΥΠΕΣ

11952	P60	50
11953	P80	50
11954	P100	50
11955	P120	50
11956	P150	50
11957	P180	50

	12969
	12970
	13822
	12971

smirdex



ΦΥΛΛΟ ΡΑΣΠΑ VELCRO (510) 70X420mm 14 ΤΡΥΠΕΣ

12969	P60	50
12970	P80	50
13822	P100	50
12971	P120	50



13635	05071	06117	07797
13636	05072	07791	07798
13637	05073	07792	07799
13638	05858	07793	07800
13639	05809	07794	07801
05069	05859	07795	
05070	06116	07796	

smirdex



VELCRO ΛΕΥΚΟ (510) ΡΟΛΟ 70mm X 25m

13635	P40	25
13636	P60	25
13637	P80	25
13638	P100	25
13639	P120	25

VELCRO ΛΕΥΚΟ (510) ΡΟΛΟ 115mm X 25m

05069	P40	25
05070	P60	25
05071	P80	25
05072	P100	25
05073	P120	25
05858	P150	25
05809	P180	25
05859	P220	25
06116	P240	25
06117	P320	25



ΠΑΤΟΧΑΡΤΟ ΛΕΥΚΟ (510) ΡΟΛΟ 115mm X 50m

07791	P40 (25m)	25
07792	P60	50
07793	P80	50
07794	P100	50
07795	P120	50
07796	P150	50
07797	P180	50
07798	P220	50
07799	P240	50
07800	P280	50
07801	P320	50

	11633		14508		12252
	14018		14509		11965
	14019		11964		07342
	14507		06305		11966
	14020		06306		11967
	14503		06646		12700
	14504		11632		14058

smirdex

ΙΔΑΝΙΚΗ ΓΙΑ ΔΥΣΚΟΛΕΣ ΕΠΙΦΑΝΕΙΕΣ!

• Η σειρά 135 αποτελεί την ιδανική λύση για λείανση δύσκολων επιφανειών αυτοκινήτου και ξύλου. Ο ειδικά επεξεργασμένος κόκκος Οξειδίου του Αλουμινίου καθιστά την σειρά 135 ιδανική για τρίψιμο επιφανειών επιστρωμένων με στόκο, αστάρι, βερνίκι, ξύλο. Επιπλέον, η ειδικής σύστασης στεατική επιστροφή βοηθά στην επιβράδυνση του μπουκώματος και στην επιμήκυνση του χρόνου ζωής του γυαλόχαρτου. Το 135sr με σφουγγάρι στο πίσω μέρος του γυαλόχαρτου είναι ιδανικό για λείανση με το χέρι επιφανειών που έχουν ακμές, καμπύλες, γωνίες και κάθε λογής δύσκολο σχήμα. Τέλος, η σειρά 135sr μπορεί να χρησιμοποιηθεί και εν μέρει σε υγρά τριβή μιας και το προϊόν με σφουγγαράκι είναι ημι-αδιάβροχο.

Εφαρμογές: Φανοποιία, Επιπλοποιία



ABRASOFT 135SP 115mm X 25m ΧΩΡΙΣ ΠΕΡΦΟΡΕ

11633	P120	25
14018	P150	25
14019	P180	25
14507	P220	25
14020	P240	25
14503	P320	25
14504	P400	25
14508	P600	25
14509	P800	25

ABRASOFT 135SP 115mm X 25m ΜΕ ΠΕΡΦΟΡΕ

11964	P120	25
06305	P150	25
06306	P180	25
06646	P220	25
11632	P240	25
12252	P280	25
11965	P320	25
07342	P400	25
11966	P500	25
11967	P600	25
12700	P800	25
14058	P1000	25



smirdex

ΥΓΡΗ ΤΡΙΒΗ ΓΙΑ ΜΑΤΑΡΙΣΜΑ ΑΥΤΟΚΙΝΗΤΩΝ!

• Η σειρά 922 Mat είναι κατάλληλη για υγρή τριβή βερνικωμένων και βαμμένων επιφανειών αυτοκινήτου. Η μεγάλη διάρκεια ζωής και το ομοιόμορφο αποτέλεσμα που προσδίδει στην επιφάνεια που τρίβεται, καθιστούν την σειρά 922 την καλύτερη επιλογή στο ματάρισμα βαμμένων και βερνικωμένων επιφανειών αυτοκινήτου και σκαφών θαλάσσης.

Εφαρμογές: Ματάρισμα στη Φανοποιία, Φινίρισμα



VELCRO MAT Φ150mm ΧΩΡΙΣ ΤΡΥΠΕΣ (922)

Barcode	Code	Quantity
12702	P1000	15
12703	P2000	15
12704	P3000	15
12705	P4000	15



smirdex

ΣΙΛΕΡΟΧΑΡΤΟ ALOX 135 ΦΥΛΛΟ 230X280mm

Barcode	Code	Quantity
02662	P60	50
02663	P80	50
02664	P100	50
02665	P120	50
02666	P150	50
02667	P180	50
02668	P220	50
02669	P240	50
13940	P280	50
07029	P320	50



	14021		02691		02694		04682
	13815		02843		02845		12738
	13816		02692		02804		13462
	13298		13026		02846		14885
	05810		02693		02847		13650
	04848		02844		04681		
	02793		02841				

smirdex

ΥΓΡΗ ΤΡΙΒΗ & ΛΕΙΑΝΣΗ ΒΕΡΝΙΚΩΜΕΝΩΝ ΕΠΙΦΑΝΕΙΩΝ

• Η σειρά 270 αποτελεί την επιτομή της ποιότητας των γυαλόχαρτων υγρής τριβής. Είναι η κατάλληλη σειρά για υγρή τριβή σε επιφάνειες αυτοκινήτου, πάνω σε αστάρι, στόκο, βερνίκι. Ο κόκκος ανθρακοपुरитίου λειάνει ομοιόμορφα την επιφάνεια, δίνοντάς της ποιοτικά αποτελέσματα γραμμών. Το εύκαμπτο χαρτί, που περιέχει 30% latex, επιτρέπει την λείανση και των πιο δύσκολων επιφανειών. Η σειρά 270 υπερέρχει στην λείανση βερνικωμένων επιφανειών όπου στα πολύ ψιλόκοκκα νούμερα (P800 και πάνω), η ποιότητα και η τραχύτητα των λειασμένων επιφανειών είναι υψίστης ομοιομορφίας και η διάρκεια ζωής πολύ μεγάλη. Οι δίσκοι νελοου 270 είναι κατάλληλοι για το σβήσιμο του φαινομένου «πορτοκάλι» μετά τη βαφή και το σβήσιμο των μπιμπικιών πριν το γυάλισμα με αλοιφές. Επίσης χρησιμοποιούνται για τέλειο ξεθάμπωμα των φαναριών των αυτοκινήτων. Εφαρμογές: Υγρή τριβή, Φινίρισμα στη Φανοποιία

Εφαρμογές: Ματάρισμα στη Φανοποιία, Φινίρισμα



VELCRO ΝΤΟΥΚΟΧΑΡΤΟ (270) Φ125 ΧΩΡΙΣ ΤΡΥΠΕΣ

14021	P3000	100
13815	P4000	100
13816	P5000	100

ΝΤΟΥΚΟΧΑΡΤΟ (270) ΦΥΛΛΟ 230X280mm

13298	P80	50
05810	P100	50
04848	P120	50
02793	P150	50
02691	P180	50
02843	P220	50
02692	P240	50
13026	P280	50
02693	P320	50
02844	P360	50
02841	P400	50
02694	P500	50
02845	P600	50
02804	P800	50
02846	P1000	50
02847	P1200	50
04681	P1500	50
04682	P2000	50
12738	P2500	50
13462	P3000	50
14885	P4000	50
13650	P5000	50





	11929		06995		11935
	11930		06996		11936
	11931		11932		11937
	06993		11933		11938
	06994		11934		11939

smirdex

ΙΔΑΝΙΚΟ ΓΙΑ ΞΥΛΙΝΑ ΠΑΤΩΜΑΤΑ & ΠΟΡΤΕΣ!

• Προτείνεται για το τρίψιμο και την λείανση παντός τύπου ξύλινων επιφανειών. Η σειρά 330 είναι το ιδανικό λειαντικό για ξύλινα πατώματα, έπιπλα, ξύλινες πόρτες και κάθε λογής ξύλο. Το βαρύ αντιστατικό χαρτί, είναι κατάλληλο για να αντέχει τις υψηλές πιέσεις κατά την διάρκεια τριβής και να αποτρέπει το γυαλόχαρτο από το να μπουκώνει. Ο ειδικής επεξεργασίας κόκκος Οξειδίου του Αλουμινίου επιταχύνει την λείανση και αυξάνει την διάρκεια ζωής του γυαλόχαρτου, αποδίδοντας εξαιρετικά αποτελέσματα τριβής.

Εφαρμογές: Ξύλο



VELCRO ΚΟΚΚΙΝΟ (330) Φ125mm ΧΩΡΙΣ ΤΡΥΠΕΣ

11929	P40	50
11930	P60	50
11931	P80	50
06993	P100	50
06994	P120	100
06995	P150	100
06996	P180	100
11932	P220	100

VELCRO ΚΟΚΚΙΝΟ (330) Φ150mm ΧΩΡΙΣ ΤΡΥΠΕΣ

11933	P40	50
11934	P60	50
11935	P80	50
11936	P100	50
11937	P120	100
11938	P150	100
11939	P180	100

	13555		13558		13561
	13556		13559		
	13557		13560		

smirdex

VELCRO ΚΟΚΚΙΝΟ (330) Φ150mm 6+1 ΤΡΥΠΕΣ

13555	P40	50
13556	P60	50
13557	P80	50
13558	P100	50
13559	P120	100
13560	P150	100
13561	P180	100

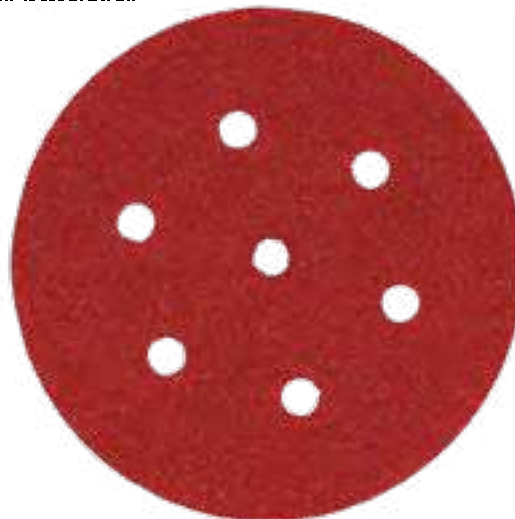

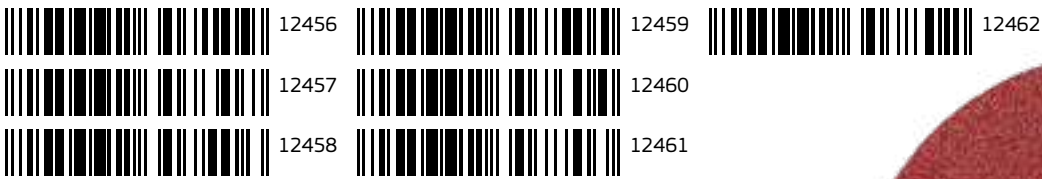

smirdex

VELCRO ΚΟΚΚΙΝΟ (330) Φ125mm 8 ΤΡΥΠΕΣ

Barcode	Icon	Quantity
12456	P40	50
12457	P60	50
12458	P80	50
12459	P100	50
12460	P120	100
12461	P150	100
12462	P180	100



smirdex

VELCRO ΚΟΚΚΙΝΟ (330) Φ150mm 8+1 ΤΡΥΠΕΣ

Barcode	Icon	Quantity
12463	P40	50
12464	P60	50
12465	P80	50
12466	P100	50
12467	P120	100
12468	P150	100
12469	P180	100



smirdex

VELCRO ΚΟΚΚΙΝΟ ΤΡΙΓΩΝΟ (330) 95X95X95mm 6 ΤΡΥΠΕΣ

Barcode	Icon	Quantity
06740	P40	50
06741	P60	50
06742	P80	50
06743	P100	50
06744	P120	50
06745	P150	50
06746	P180	50





02848	01878	02679	04849
02670	04982	02680	00829
02671	12972	01624	08403
02672	02792	03153	04229
02673	02676	06419	04230
02674	02677	15425	04231
02796	02678	15426	13054
02675			

smirdex

GET IT NOW

ΠΑΤΟΧΑΡΤΟ ΚΟΚΚΙΝΟ (330) ΡΟΛΟ 115mm X 25m

02848	P24	25
02670	P36	25
02671	P40	25
02672	P60	25
02673	P80	25
02674	P100	25
02796	P120	25
02675	P150	25
01878	P180	25
04982	P220	25
12972	P240	25



ΡΟΛΟ 200mm X 25m

02792	P24	25
02676	P36	25
02677	P40	25
02678	P60	25
02679	P80	25
02680	P100	25
01624	P120	25
03153	P150	25
06419	P180	25
15425	P320	25
15426	P400	25

ΡΟΛΟ 300mm X 25m

04849	P24	25
00829	P36	25
08403	P40	25
04229	P60	25
04230	P80	25
04231	P100	25
13054	P120	25

 07176	 01464	 02798
 03555	 02600	 02799
 03556	 04156	 02800
 03596	 02802	 02794
 03558	 13596	 02801
 02442	 05110	 02377
 01463	 02797	 05189

smirdex



ΚΑΤΑΛΛΗΛΟ ΓΙΑ ΣΚΛΗΡΕΣ ΞΥΛΙΝΕΣ ΕΠΙΦΑΝΕΙΕΣ!

• Η σειρά 350 αποτελεί την ιδανική επιλογή για τριβή σκληρών επιφανειών ξύλου και δέρματος. Ο κόκκος ανθρακοπυριτίου δρα καταλυτικά στην ποιοτική τριβή δίνοντας ομοιόμορφα λειασμένες επιφάνειες. Όλων των ειδών τα έπιπλα, ξύλινα πατώματα, ξύλινες πόρτες και κάθε είδος σκληρού ξύλου μπορούν να λειανθούν με την σειρά 350. Το βαρύ αντιστατικό χαρτί, είναι κατάλληλο για να αντέχει τις υψηλές πιέσεις κατά την διάρκεια τριβής και να αποτρέπει το γυαλόχαρτο από το να μπουκώσει.



Εφαρμογές: σκληρά ξύλα, πάτωμα, οικοδομή





ΠΑΤΟΧΑΡΤΟ ΜΑΥΡΟ (350) ΡΟΛΟ 115mm X 25m

		
07176	P24	25
03555	P36	25
03556	P40	25
03596	P60	25
03558	P80	25
02442	P100	25
01463	P120	25
01464	P150	25
02600	P180	25
04156	P220	25

ΡΟΛΟ 200mm X 25m

		
02802	P36	25
13596	P40	25
05110	P60	25
02797	P80	25
02798	P100	25
02799	P120	25
02800	P150	25
02794	P180	25
02801	P240	25

ΡΟΛΟ 300mm X 25m

		
02377	P24	25
05189	P36	25



	02842		02838
	00455		00781
	02805		05446
	02837		01746
	02806		01744

smirdex

GET IT NOW

ΚΑΤΑΛΛΗΛΟ ΓΙΑ ΑΣΤΑΡΩΜΕΝΕΣ ΕΠΙΦΑΝΕΙΕΣ!

• Η σειρά αυτή είναι κατάλληλη για ομοιόμορφη λείανση ξύλινων και ασταρομένων επιφανειών. Η ανοικτή δομή των κόκκων ανθρακοπυρίτιου δημιουργεί τέλειο φινίρισμα και σε συνδυασμό με την ειδική στεατική επιστρώση δεν αφήνει το φύλλο να μπουκώσει γρήγορα, χαρίζοντάς του επιπλέον διάρκεια ζωής.

Εφαρμογές: Ξύλο/βερνίκι (Επιλοποιία)



ΦΡΙ-KAT (140) ΦΥΛΛΟ 230X280mm

02842	P80	50
00455	P100	100
02805	P120	100
02837	P150	100
02806	P180	100
02838	P220	100
00781	P240	100
05446	P280	100
01746	P320	100
01744	P400	100

	06184		06783
	06185		06106
	04341		00826
	04340		06649
	04333		06650
	04342		06651

smirdex

ΚΑΤΑΛΛΗΛΟ ΓΙΑ ΜΕΤΑΛΛΟ & ΞΥΛΟ!

• Η σειρά J-Cloth 650 από εύκαμπτο βαμβακερό πανί τύπου J, είναι κατάλληλη για την λείανση μετάλλων και σκληρού ξύλου. Η εύκαμπτη βαμβακερή δομή του πανιού προσδίδει εξαιρετική αντοχή στην λείανση δύσκολων επιφανειών και προσαρμοστικότητα στις καμπυλόγραμμες επιφάνειες. Η κλειστή δομή κόκκων του Οξειδίου του Αλουμινίου δρα καταλυτικά στην άριστη απόδοση τριβής των μεταλλικών επιφανειών και σκληρών ξύλινων επιφανειών.

Εφαρμογές: Ξύλο, μέταλλο



ΣΜΥΡΙΔΟΠΑΝΟ (650) ΦΥΛΛΟ 230X280mm

06184	P36	50
06185	P40	50
04341	P60	50
04340	P80	50
04333	P100	50
04342	P120	50
06783	P150	50
06106	P180	50
00826	P220	50
06649	P240	50
06650	P320	50
06651	P400	50

	06978		06511		04151		05569
	03423		06512		06579		05570
	03424		15481		06580		04800
	03425		15482		11044		04801
	03426		06247		15483		06572
	03427		06248		11204		06573
	03428		04149		11101		06574
	04984		04150		15484		06575
	03429		04797		11205		13248
	06949		06576		06958		13649
	03430		06577		04798		13249
	04500		06578		04799		

smirdex

GET IT NOW

ΚΑΤΑΛΛΗΛΗ ΓΙΑ ΜΑΡΜΑΡΟ!

• Η σειρά 355 αποτελεί την ιδανική επιλογή για τριβή μαρμάρων. Ο κόκκος ανθρακοκυριτίου δρα καταλυτικά στην ποιοτική τριβή δίνοντας ομοιόμορφα λειασμένες επιφάνειες και η υψηλή σκληρότητά του επιδρά θετικά στην γρήγορη τριβή και στην μακρά διάρκεια ζωής. Η εξαιρετικά δυνατή κόλληση των κόκκων με ειδικές ρητίνες, δίνουν ένα λειαντικό υψηλής αντοχής και σκληρότητας, ικανό να αντέξει στην εφαρμογή υψηλών πιέσεων σε πολύ σκληρές επιφάνειες όπως αυτές του μαρμάρου. Το βαρύ αντιστατικό χαρτί, είναι κατάλληλο για να αντέχει τις υψηλές πιέσεις και θερμοκρασίες κατά την διάρκεια τριβής και να αποτρέπει το γυαλόχαρτο από το να μπουκώσει.

Εφαρμογές: μάρμαρο



VELCRO ΜΑΥΡΟ (355) Φ115mm ΧΩΡΙΣ ΤΡΥΠΕΣ

06978	P36	50
03423	P40	50
03424	P60	50
03425	P80	50
03426	P100	50
03427	P120	50
03428	P150	50
04984	P180	100
03429	P220	100
06949	P240	100
03430	P320	100
04500	P400	100
06511	P600	100
06512	P800	100
15481	P1000	100
15482	P1200	100

Φ125mm ΧΩΡΙΣ ΤΡΥΠΕΣ

06247	P36	50
06248	P40	50
04149	P60	50
04150	P80	50
04797	P100	50
06576	P120	50
06577	P150	50
06578	P180	100
04151	P220	100
06579	P240	100
06580	P320	100
11044	P400	100
15483	P500	100
11204	P600	100
11101	P800	100
15484	P1000	100
11205	P1200	100

Φ150mm ΧΩΡΙΣ ΤΡΥΠΕΣ

06958	P36	50
04798	P40	50
04799	P60	50
05569	P80	50
05570	P100	50
04800	P120	50
04801	P150	50
06572	P180	50
06573	P220	50
06574	P240	50
06575	P320	50
13248	P400	50
13649	P600	50
13249	P1000	50



13088	06736	01998
01959	06751	03092
02860	06752	00324
02122	06753	01995
02435	06754	03093
03091	06755	02541
01085	07577	03160
01211		

smirdex

ΔΙΣΚΟΙ ΓΙΑ ΜΑΡΜΑΡΟ & ΤΣΙΜΕΝΤΟ!

ΔΙΣΚΟΣ SUPER ΦΙΜΠΕΡ (935) Φ115m

13088	P16	5
01959	P24	5
02860	P36	5
02122	P40	5
02435	P60	5
03091	P80	5
01085	P100	5
01211	P120	5

(935) Φ125m

06736	P24	5
06751	P36	5
06752	P40	5
06753	P60	5
06754	P80	5
06755	P100	5
07577	P120	5

(935) Φ180m

01998	P24	5
03092	P36	5
00324	P40	5
01995	P60	5
03093	P80	5
02541	P100	5
03160	P120	5



 11252	 04737	 13521
 04733	 04738	 13522
 04734	 05032	 13523
 04501	 13517	 13524
 04735	 13518	 13525
 04502	 13519	 13526
 04736	 13520	 13678

smirdex



ΚΑΤΑΛΛΗΛΟ ΓΙΑ ΣΚΛΗΡΕΣ ΕΠΙΦΑΝΕΙΕΣ!

• Η σειρά J-Superflex 640 κατασκευασμένη από δυνατό βαμβακερό και πολύ εύκαμπτο πανί τύπου J, είναι κατάλληλη για την λείανση μετάλλων και σκληρού ξύλου. Η πολύ εύκαμπτη βαμβακερή δομή του πανιού προσδίδει εξαιρετική αντοχή στην λείανση δύσκολων επιφανειών και προσαρμοστικότητα στις καμπυλόγραμμες επιφάνειες. Η κλειστή δομή κόκκων ειδικά επεξεργασμένου Οξειδίου του Αλουμινίου δρα καταλυτικά στην άριστη απόδοση τριβής των μεταλλικών επιφανειών και σκληρών ξύλινων επιφανειών.



Εφαρμογές: ξύλο, μέταλλο



ΣΜΥΡΙΔΟΠΑΝΟ ΚΟΚΚΙΝΟ J-SUPERFLEX (640) ΡΟΛΟ 115mmX25m

		
11252	P40	25
04733	P60	25
04734	P80	25
04501	P100	25
04735	P120	25
04502	P150	25
04736	P180	25
04737	P220	25
04738	P240	25
05032	P320	25

ΡΟΛΟ 200mmX25m

		
13517	P40	25
13518	P60	25
13519	P80	25
13520	P100	25
13521	P120	25
13522	P150	25
13523	P180	25
13524	P220	25
13525	P240	25
13526	P320	25
13678	P400	25



12795



13784



05485



03645



13461

smirdex



ΣΜΥΡΙΔΟΠΑΝΟ X-CLOTH (630) ΡΟΛΟ 50mm X 25m

Barcode	Icon	Quantity
12795	P30	25
13784	P80	25

ΡΟΛΟ 115mm X 25m

Barcode	Icon	Quantity
05485	P36	25
03645	P40	25

ΡΟΛΟ 200mm X 25m

Barcode	Icon	Quantity
13461	30	12
14042	P36	12
14120	P40	12
14121	P60	12
14122	P80	12



14042



14120



14121



14122



ΚΑΤΑΛΛΗΛΟ ΓΙΑ ΣΚΛΗΡΕΣ ΕΠΙΦΑΝΕΙΕΣ!

• Η σειρά 630 είναι λειαντικά με υπόστρωμα πολύ ανθεκτικού βαμβακερού πανιού τύπου X, κατάλληλα για λείανση επιφανειών σκληρού ξύλου. Το πολύ δυνατό βαμβακερό πανί προσδίδει εξαιρετική αντοχή στην λείανση δύσκολων επιφανειών και η κλειστή δομή κόκκων του Οξειδίου του Αλουμινίου δρα καταλυτικά στην άριστη απόδοση τριβής των ξύλινων επιφανειών. Η σειρά 630 προσφέρεται και σε ιμάντες.

Εφαρμογές: ξύλο

ΙΜΑΝΤΑΣ ΠΑΝΙ X-CLOTH (630) 50X220mm

Barcode	Icon	Quantity
08950	P60	12
08951	P100	12
10238	P150	12
08984	P180	12
14574	P220	12

50X686mm

Barcode	Icon	Quantity
14967	P60	12
13438	P80	12
10447	P100	12
10448	P120	12
13439	P150	12
13399	P220	12
13400	P240	12

50X800mm

Barcode	Icon	Quantity
05437	P120	12
14968	P240	12

08950	05437	14460	14876
08951	14968	14522	14546
10238	14915	07890	13817
08984	14916	07891	04471
14574	13693	05924	13818
14967	14917	05925	13689
13438	07044	05926	06598
10447	07045	05927	06771
10448	07046	08943	13081
13439	07047	08944	13082
13399	07048	14875	14505
13400	07084		

smirdex



ΙΜΑΝΤΑΣ ΠΑΝΙ Χ-CLOTH (630) 50X1800mm

14915	P40	9
14916	P80	9
13693	P100	12
14917	P120	9

75X457mm

07044	P40	5
07045	P60	5
07046	P80	5
07047	P100	5
07048	P120	5
07084	P150	5
14460	P320	5

75X510mm

14522	P40	5
07890	P60	5
07891	P80	5

75X535mm

05924	P40	5
05925	P60	5
05926	P80	5
05927	P100	5
08943	P120	5
08944	P180	5

100X560mm

14875	P60	5
14876	P100	5

100X610mm

14546	P40	5
13817	P60	5
04471	P80	5
13818	P100	5
13689	P120	5

100X620mm

06598	P120	5
06771	P150	5

100X915mm

13081	P60	10
13082	P120	10
14505	P400	5



14463	13395	12630
13602	13644	12631
14567	14697	12632
13477	14698	12633
13393	14080	12634
13394	14699	12635
13642	14557	12636
13643		

smirdex

ΙΔΑΝΙΚΟ ΓΙΑ ΣΚΛΗΡΕΣ ΕΠΙΦΑΝΕΙΕΣ!

• Η σειρά ZX 635 σε υπόστρωμα ανθεκτικού βαμβακερού πανιού τύπου X, είναι κατάλληλη για τη λείανση επιφανειών σκληρών ξύλων, πατωμάτων και μεταλλικών επιφανειών. Το πολύ δυνατό βαμβακερό πανί προσδίδει εξαιρετική αντοχή στην λείανση δύσκολων επιφανειών και η κλειστή δομή κόκκων Ζιρκονίου Αλουμινίου δρα καταλυτικά στην άριστη απόδοση τριβής. Η σειρά ZX-635 έχει χαρακτηριστικά πολύ γρήγορους ρυθμούς τριβής χάρη στους κόκκους ζιρκονίου. Προσφέρεται και σε ιμάντες.

Εφαρμογές: πολύ σκληρό ξύλο, παρκέ, μέταλλο



ΙΜΑΝΤΑΣ ΠΑΝΙ ΖΙΡΚΟΝΙΟΥ (ZX-635) 200mmX480m

13393	P36	5
13394	P60	10
13642	P80	10
13643	P100	10
13395	P120	5
13644	P150	5



ΠΑΤΟΧΑΡΤΟ ΖΙΡΚΟΝΙΟΥ (ZX-635) ΡΟΛΟ 115mmX25m













14463	P60	25
13602	P80	25
14567	P100	25
13477	P120	25

200mmX550m

14697	P36	5
14698	P60	5
14080	P120	10
14699	P150	10

200mmX750m



14557	P24	10
12630	P36	10
12631	P40	10
12632	P60	10
12633	P80	10
12634	P100	5
12635	P120	5
12636	P150	5

 03453	 05502	 02808	 00030
 05268	 05503	 01480	 03736
 03454	 05504	 02646	 02045
 03455	 05505	 00877	 01637
 03456	 05448	 01900	 03118
 03457	 05766	 02015	 01756
 03458	 05447	 01387	 00119
 03459	 05452	 02795	 03116
 03460	 05449	 01367	 01601
 00776	 05453	 00814	 03117

smirdex



Εφαρμογές: Μάρμαρο

ΔΙΣΚΟΣ ΜΑΥΡΟΣ ΦΙΜΠΕΡ (932) Φ115mm



		
03453	P24	50
05268	P36	50
03454	P40	50
03455	P60	50
03456	P80	50
03457	P100	50
03458	P120	50
03459	P150	50
03460	P180	50
00776	P220	50





Φ125mm

		
05502	P24	50
05503	P36	50
05504	P40	50
05505	P60	50
05448	P80	50
05766	P100	50
05447	P120	50
05452	P150	50
05449	P180	50
05453	P220	50

Φ150mm

		
02808	P24	50
01480	P36	50
02646	P40	50
00877	P60	50
01900	P80	50
02015	P100	50
01387	P120	50
02795	P150	50
01367	P180	50
00814	P220	50

Φ180mm

		
00030	P24	50
03736	P36	50
02045	P40	50
01637	P60	50
03118	P80	50
01756	P100	50
00119	P120	50
03116	P150	50
01601	P180	50
03117	P220	50



	15313		13284		13588		13597
	02682		07013		02644		02653
	02683		07014		02645		02654
	02684		07015		01926		02655
	02685		07016		02647		02656
	02686		07017		02648		02657
	02687		06979		02649		02658
	02688		07018		02650		02659
	02689		11297		02651		02660
	02690				02652		02661

smirdex

Εφαρμογές: Μέταλλο/Ξύλο

ΔΙΣΚΟΣ ΚΟΚΚΙΝΟΣ ΦΙΜΠΕΡ (930) Φ115mm

15313	P16	25
02682	P24	50
02683	P36	50
02684	P40	50
02685	P60	50
02686	P80	50
02687	P100	50
02688	P120	50
02689	P150	50
02690	P180	50

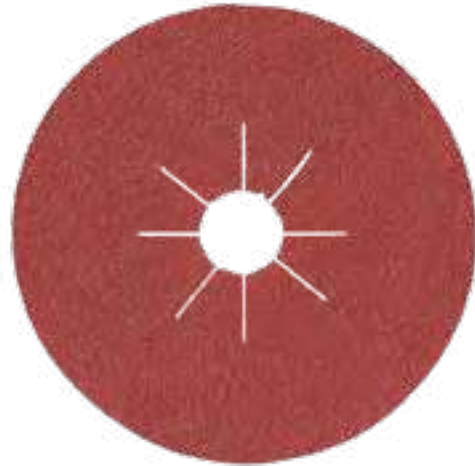

Φ125mm

13284	P16	25
07013	P24	50
07014	P36	50
07015	P40	50
07016	P60	50
07017	P80	50
06979	P100	50
07018	P120	50
11297	P150	50

Φ150mm

13588	P16	25
02644	P24	50
02645	P36	50
01926	P40	50
02647	P60	50
02648	P80	50
02649	P100	50
02650	P120	50
02651	P150	50
02652	P180	50

Φ180mm

13597	P16	25
02653	P24	50
02654	P36	50
02655	P40	50
02656	P60	50
02657	P80	50
02658	P100	50
02659	P120	50
02660	P150	50
02661	P180	50

	01386		07230
	01067		07231
	03208		07578
	03209		03461
	00603		02973
	00425		02774
	07306		02783
	07228		02972
	07229		03939

smirdex

GET IT NOW

Εφαρμογές: Μέταλλο, inox



ΔΙΣΚΟΣ ΛΕΙΑΝΣΗΣ ΜΕ ΠΤΕΡΥΓΙΑ ΜΠΛΕ (915) Φ115mm

01386	P36	10
01067	P40	10
03208	P60	10
03209	P80	10
00603	P100	10
00425	P120	10

Φ125mm

07306	P36	10
07228	P40	10
07229	P60	10
07230	P80	10
07231	P100	10
07578	P120	10

Φ180mm

03461	P36	10
02973	P40	10
02774	P60	10
02783	P80	10
02972	P100	10
03939	P120	10

	12813		12818
	12814		12819
	12815		12820
	12816		12821
	12817		12822

smirdex

Εφαρμογές: Σκληρό μέταλλο



ΔΙΣΚΟΣ ΛΕΙΑΝΣΗΣ ΜΕ ΠΤΕΡΥΓΙΑ ΚΟΚΚΙΝΟΣ (915) Φ115mm

12813	P36	10
12814	P40	10
12815	P60	10
12816	P80	10
12817	P100	10

Φ125mm

12818	P36	10
12819	P40	10
12820	P60	10
12821	P80	10
12822	P100	10



	05805		06634
	05806		06850
	05807		06635
	05808		06639
	06633		06640

smirdex



VELCRO FLEX ΛΕΥΚΟ (510) Φ225mm ΧΩΡΙΣ ΤΡΥΠΕΣ

05805	P60	50
05806	P80	100
05807	P100	100
05808	P120	100
06633	P150	100
06634	P180	100
06850	P220	100
06635	P240	100
06639	P320	100
06640	P400	100

	06862		06871
	06863		06872
	06866		06864
	06870		06975

smirdex



VELCRO FLEX ΛΕΥΚΟ (510) Φ220mm 1 ΤΡΥΠΑ

06862	P60	50
06863	P80	100
06866	P100	100
06870	P120	100
06871	P150	100
06872	P180	100
06864	P220	100
06975	P240	100

	15336		13030
	13027		13031
	13028		13032
	13029		13033

smirdex

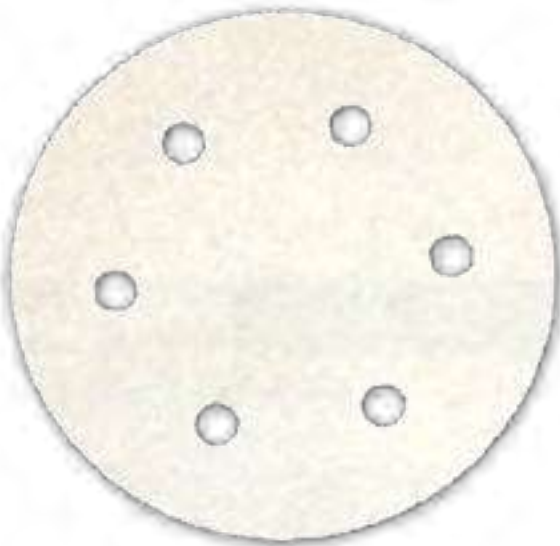

**VELCRO FLEX ΛΕΥΚΟ (510) Φ225mm
6 ΤΡΥΠΕΣ**

15336	P40	50
13027	P60	50
13028	P80	100
13029	P100	100
13030	P120	100
13031	P150	100
13032	P180	100
13033	P220	100

	15158		15162
	15159		15163
	15160		15164
	15161		15165

smirdex

NEW
ARRIVAL

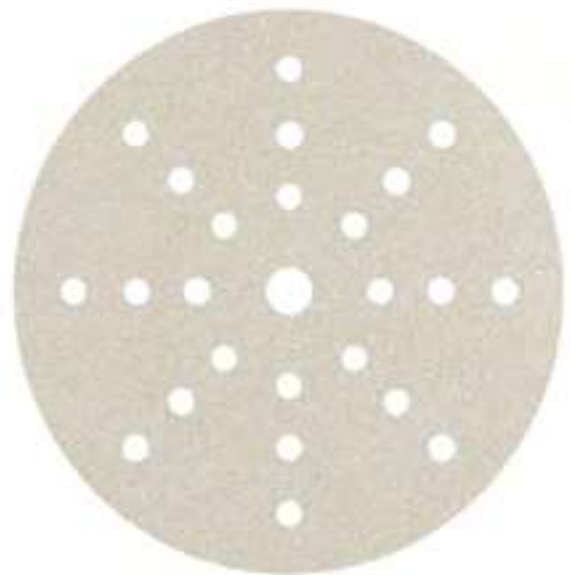

**VELCRO FLEX ΛΕΥΚΟ (510) Φ225mm
24+1 ΤΡΥΠΕΣ**

15158	P40	50
15159	P60	50
15160	P80	100
15161	P100	100
15162	P120	100
15163	P150	100
15164	P180	100
15165	P220	100



	14956		13246		10597		06779
	13241		13247		10598		06789
	13242		14409		10599		14514
	13243		10594		10600		
	13244		10595		06969		
	13245		10596		06778		

smirdex



VELCRO FLEX CERAMIC NET (750) Φ225mm

14956	P60	50
13241	P80	50
13242	P100	50
13243	P120	50
13244	P150	50
13245	P180	50
13246	P220	50
13247	P240	50
14409	P400	50



VELCRO FLEX ΜΑΥΡΟ (350) DURAL Φ225mm ΧΩΡΙΣ ΤΡΥΠΕΣ

10594	P16	25
10595	P24	50
10596	P36	50
10597	P40	50
10598	P60	50
10599	P80	50
10600	P100	50

VELCRO FLEX ΜΑΥΡΟ (350) DURAL Φ220mm ΧΩΡΙΣ ΤΡΥΠΕΣ

06969	P16	25
06778	P24	50
06779	P36	50
06789	P40	50

VELCRO FLEX ΜΑΥΡΟ (355) DURAL Φ220mm 1 ΤΡΥΠΑ

14514	P80	50



smirdex



**ΠΕΤΣΕΤΑΚΙ ΚΑΘΑΡΙΣΜΟΥ (925) Φ150mm
ΧΩΡΙΣ ΤΡΥΠΕΣ**

Barcode	Product Name	Quantity
12615	AVF P320 κόκκινο	10



07052



06030



13651

smirdex



**ΠΕΤΣΕΤΑΚΙ ΚΑΘΑΡΙΣΜΟΥ (925) ΦΥΛΛΟ
150X230mm**

Barcode	Product Name	Quantity
07052	AVF P320 κόκκινο	10
06030	SUF P600 γκρι	10
13651	SMF P1000 κίτρινο	10



06748



06749



06750

smirdex



**ΠΕΤΣΕΤΑΚΙ ΚΑΘΑΡΙΣΜΟΥ (925) ΡΟΛΛΟ
115mm X 10m**

Barcode	Product Name	Quantity
06748	AVF P320 κόκκινο	10
06749	SUF P600 γκρι	10
06750	SMF P1000 κίτρινο	10

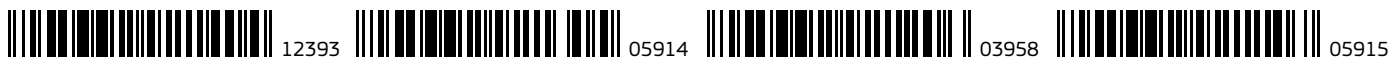

smirdex

GET IT NOW

ΛΕΙΑΝΤΙΚΟ ΣΦΟΥΓΓΑΡΑΚΙ (920) ΔΙΠΛΕΥΡΟ 2Χ2

Barcode	Icon	Quantity
12393	Πολύ ψιλό	24
05914	Ψιλό	24
03958	Μεσαίο	24
05915	Χοντρό	24



smirdex

HOT SELLER

GET IT NOW

ΛΕΙΑΝΤΙΚΟ ΣΦΟΥΓΓΑΡΑΚΙ (920) ΤΕΤΡΑΠΛΕΥΡΟ 4Χ4

Barcode	Icon	Quantity
03165	Πολύ ψιλό	24
03166	Ψιλό	24
02681	Μεσαίο	24
02362	Χοντρό	24



smirdex

GET IT NOW

ΛΕΙΑΝΤΙΚΟ ΣΦΟΥΓΓΑΡΑΚΙ (920) ΠΟΛΥΜΟΡΦΙΚΟ 4Χ4

Barcode	Icon	Quantity
11969	Πολύ ψιλό	24
07818	Ψιλό	24
07819	Μεσαίο	24
07820	Χοντρό	24





smirdex

NEW
ARRIVAL



ΠΟΥΔΡΑ (ΦΟΥΜΟ) ΟΔΗΓΟΣ ΞΗΡΑΣ ΤΡΙΒΗΣ ΜΕ ΤΑΚΟ ΕΦΑΡΜΟΓΗΣ (975)

15308	100gr	12



14733



14735



14734



14736

smirdex

NEW
ARRIVAL



ΑΛΟΙΦΗ ΓΥΑΛΙΣΜΑΤΟΣ

14733	Χονδρή (923) - 250ml	6
14734	Χονδρή (923) - 1000ml	6
14735	Ψιλή (924) - 250ml	6
14736	Ψιλή (924) - 1000ml	6



smirdex



ΤΡΙΒΙΔΙ ΠΑΛΑΜΗΣ ΓΙΑ VELCRO (967)

12697	70x125mm	1



smirdex



ΚΟΡΔΟΝΙ ΜΑΣΚΑΡΙΣΜΑΤΟΣ (921)

11968	Φ13mm x 50m	1

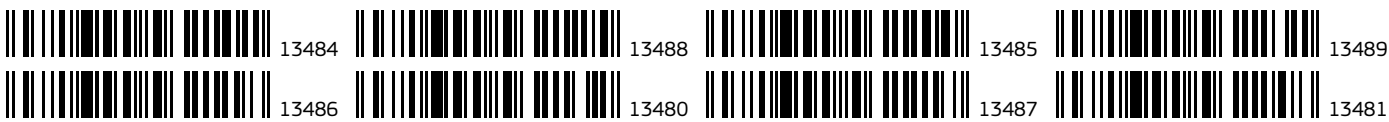

13484

13488

13485

13489



13486



13480



13487



13481

smirdex

ΔΙΣΚΟΣ ΓΥΑΛΙΣΜΑΤΟΣ ΡΟΛΙΜΑΧΧ Φ115mm

Barcode	Icon	Quantity
13484	Τραχύς (No1)	10
13486	Μεσαίος (No2)	10
13488	Ψιλός (No3)	10
13480	Πολύ ψιλός (No4)	10

Φ125mm

Barcode	Icon	Quantity
13485	Τραχύς (No1)	10
13487	Μεσαίος (No2)	10
13489	Ψιλός (No3)	10
13481	Πολύ ψιλός (No4)	10



14577



14578

osborn

NEW ARRIVAL



ΔΙΣΚΟΣ ΓΥΑΛΙΣΜΑΤΟΣ - ΚΑΘΑΡΙΣΜΟΥ

Barcode	Icon	Quantity
14577	Φ115mm	10
14578	Φ125mm	10



osborn

NEW ARRIVAL



ΔΙΣΚΟΙ ΓΥΑΛΙΣΜΑΤΟΣ - ΚΑΘΑΡΙΣΜΟΥ Φ115mm & Φ125mm ΣΕ ΕΚΘΕΤΗΡΙΟ 36τμχ.

Barcode	Icon	Quantity
14579	18τμχ. Φ115mm & 18τμχ. Φ 125mm	1

10650 10651
06939

smirdex



GET IT NOW

ΒΑΣΗ VELCRO ΠΟΛΥΟΥΡΕΘΑΝΗΣ ΓΩΝΙΑΚΟΥ ΤΡΟΧΟΥ (944)

Barcode	Icon	Box
10650	Φ115mm	5
06939	Φ125mm	5
10651	Φ150mm	5

14431 14957
14439

smirdex



NEW ARRIVAL

ΒΑΣΗ VELCRO ΠΟΛΥΟΥΡΕΘΑΝΗΣ ΓΩΝΙΑΚΟΥ ΤΡΟΧΟΥ ΕΠΑΓΓΕΛΜΑΤΙΚΗ (944)

Barcode	Icon	Box
14431	Φ115mm	5
14439	Φ125mm	5
14957	Φ150mm	5

05952 06801
05748

smirdex



GET IT NOW

ΒΑΣΗ VELCRO ΠΛΑΣΤΙΚΗ ΓΩΝΙΑΚΟΥ ΤΡΟΧΟΥ (946)

Barcode	Icon	Box
05952	Φ115mm	5
05748	Φ125mm	5
06801	Φ150mm	5

00961 00385
00807



ΒΑΣΗ VELCRO ΓΩΝΙΑΚΟΥ ΤΡΟΧΟΥ

Barcode	Icon	Box
00961	Φ115mm	5
00807	Φ125mm	5
00385	Φ150mm	5

15275 14137
14759

smirdex



NEW ARRIVAL

ΒΑΣΗ ΜΑΛΑΚΗ ΕΝΔΙΑΜΕΣΗ 97 ΤΡΥΠΕΣ Φ150mm (950)

Barcode	Icon	Box
15275	2mm	10
14759	5mm	10
14137	10mm	10

smirdex



ΒΑΣΗ VELCRO ΕΠΑΓΓΕΛΜΑΤΙΚΗ 6, 7, 8, 9, 15 ΤΡΥΠΕΣ (960)

Barcode	Icon	Box
12698	Φ150mm	1



smirdex



ΒΑΣΗ VELCRO ΑΥΤΟΚΟΛΛΗΤΗ ΓΩΝΙΑΚΟΥ ΤΡΟΧΟΥ (5104)

Barcode	Icon	Quantity
03625	Φ115mm χωρίς τρύπες	5
03936	Φ125mm χωρίς τρύπες	5
11514	Φ125mm με 8 τρύπες	5
03031	Φ150mm χωρίς τρύπες	5
11515	Φ150mm με 7 τρύπες	5
12533	Φ150mm με 9 τρύπες	5
13733	Φ203mm χωρίς τρύπες	5
06641	Φ220mm χωρίς τρύπες	5
12802	Φ115x230mm χωρίς τρύπες	5
12803	Φ115x230mm με 10 τρύπες	5



smirdex

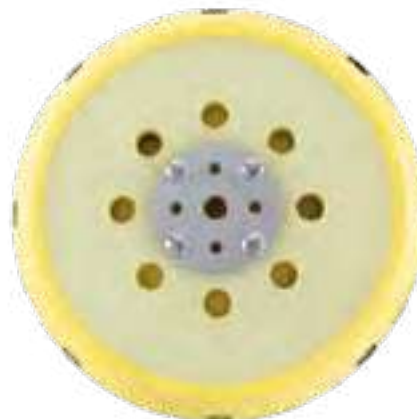

ΒΑΣΗ VELCRO ΕΚΚΕΝΤΡΩΝ ΤΡΙΒΕΙΩΝ (960)

Barcode	Icon	Quantity
10307	Φ125mm χωρίς τρύπες	1
11970	Φ125mm με 8 τρύπες	1
10308	Φ150mm χωρίς τρύπες	1
12431	Φ150mm με 7 τρύπες	1
11971	Φ150mm με 9 τρύπες	1
13154	Φ150mm με 15 τρύπες	1



smirdex

Ιδανική για
τα λειαντικά
της σειράς
CERAMIC-NET



ΒΑΣΗ ΠΟΛΥΤΡΥΠΗ 97 ΤΡΥΠΕΣ (960)

Barcode	Icon	Quantity
13155	Φ150mm	1



smirdex



ΒΑΣΗ VELCRO (948) ΓΙΑ FLEX (ΠΛΑΤΟ)

Barcode	Icon	Quantity
06823	Φ210mm	10

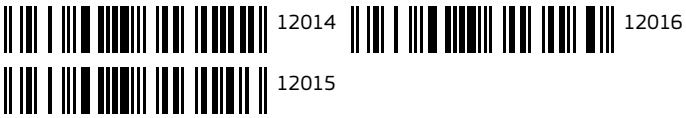

12014

12016



12015

INTER



ΒΑΣΗ VELCRO ΠΟΛΥΟΥΡΕΘΑΝΗΣ ΓΩΝΙΑΚΟΥ ΤΡΟΧΟΥ

Barcode	Icon	Quantity
12014	☑	12
12015	☑	12
12016	☑	12



02086

02590



00672

02591



ΒΑΣΗ ΦΙΜΠΕΡ ΛΕΥΚΗ ΓΩΝΙΑΚΟΥ ΤΡΟΧΟΥ

Barcode	Icon	Quantity
02086	☑	10
00672	☑	10
02590	☑	10
02591	☑	10

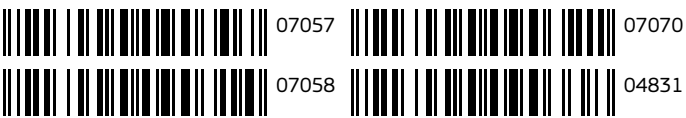

07057

07070



07058

04831



ΒΑΣΗ ΦΙΜΠΕΡ ΛΕΥΚΗ ΣΕΤ ΓΩΝΙΑΚΟΥ ΤΡΟΧΟΥ

Barcode	Icon	Quantity
07057	☑	10
07058	☑	10
07070	☑	10
04831	☑	10



ΒΑΣΗ ΦΙΜΠΕΡ ΔΡΑΠΑΝΟΥ

Barcode	Icon	Quantity
02087	☑	10



ΠΑΞΙΜΑΔΙΑ - ΤΡΟΧΟΚΛΕΙΔΑ



ΠΑΞΙΜΑΔΙ ΤΡΟΧΟΥ ΚΩΝΙΚΟ ΓΙΑ ΦΙΜΠΕΡ

03250	M14	10



ΠΑΞΙΜΑΔΙ ΤΡΟΧΟΥ ΙΣΙΟ

01253	M14	10



ΑΞΟΝΑΚΙ ΑΝΤΑΠΤΟΡΑΣ ΔΡΑΠΑΝΟΥ ΓΙΑ ΒΑΣΗ VELCRO M14

01516	M14	10



ΤΡΟΧΟΚΛΕΙΔΟ ΤΑΪΒΑΝ

03416	Ρυθμιζόμενο	5

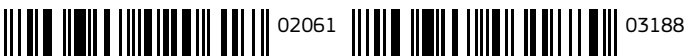

02061

03188



03187



ΤΡΟΧΟΚΛΕΙΔΟ ΓΙΑ ΠΑΞΙΜΑΔΙ

02061	No 1	10
03187	No 2	10
03188	No 3	10



ΤΡΟΧΟΚΛΕΙΔΟ ΓΙΑ ΑΞΟΝΑ

03189	No 17	10



ΠΟΛΥΜΠΡΙΖΟ ΣΟΥΚΟ 3Χ1,0mm²

01288	3 υποδοχές	5



ΑΝΤΑΠΤΟΡΑΣ ΣΟΥΚΟ ΣΤΑΥΡΟΥ

09300	3 υποδοχές	5



ΠΟΛΥΜΠΡΙΖΟ ΣΟΥΚΟ ΜΕ ΔΙΑΚΟΠΤΗ 3Χ1,0mm²

02775	4 υποδοχές	5
00064	5 υποδοχές	5



ΑΝΤΑΠΤΟΡΑΣ ΣΟΥΚΟ ΤΑΦ

09299	2 υποδοχές	5



ΦΙΣ ΣΟΥΚΟ

09292	Αρσενικό	10
09293	Θηλυκό	10



ΠΡΟΕΚΤΑΣΗ ΚΑΛΩΔΙΟ ΣΟΥΚΟ ΓΩΝΙΑΚΟ 3Χ1,5mm²

09288	3 υποδοχές	5
09289	5 υποδοχές	5
11462	10 υποδοχές	3



ΠΡΟΕΚΤΑΣΗ ΚΑΛΩΔΙΟ ΣΟΥΚΟ ΕΥΘΥ 3Χ1,5mm²

Barcode	Icon	Box
09290	15m	5
09291	30m	5



ΜΠΑΛΑΝΤΕΖΑ ΠΛΑΣΤΙΚΟ ΚΑΡΟΥΛΙ ΧΩΡΙΣ ΚΑΛΩΔΙΟ

Barcode	Icon	Box
09282	Μικρή	1
09283	Μεγάλη	1



ΜΠΑΛΑΝΤΕΖΑ ΠΛΑΣΤΙΚΟ ΚΑΡΟΥΛΙ ΜΕ ΚΑΛΩΔΙΟ

Barcode	Icon	Box
04024	3x1,5mm ² - 25m	1
07568	3x1,5mm ² - 33m	1
01476	3x1,5mm ² - 50m	1
05699	3x2,5mm ² - 33m	1
05700	3x2,5mm ² - 50m	1



ΜΠΑΛΑΝΤΕΖΑ ΜΕΤΑΛΛΙΚΟ ΚΑΡΟΥΛΙ ΜΕ ΚΑΛΩΔΙΟ

Barcode	Icon	Box
15616	3x2,5mm ² - 50m	1

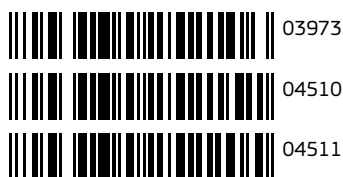

ΜΠΑΛΑΝΤΕΖΑ ΚΛΕΙΣΤΟΥ ΤΥΠΟΥ 3Χ1,5mm²

Barcode	Icon	Box
03973	2 ΥΠΟΔΟΧΕΣ - 10m	1
04510	4 ΥΠΟΔΟΧΕΣ - 15m	1
04511	4 ΥΠΟΔΟΧΕΣ - 20m	1

 11153
 11154



ΦΑΚΟΣ ΦΛΑΣ ΣΙΝΙΑΛΟ ΚΙΝΔΥΝΟΥ

		
11153	Κίτρινος	2
11154	Μπαταρία 6V	6





ΜΠΑΛΑΝΤΕΖΑ ΣΥΝΕΡΓΕΙΟΥ

		
03995	220Volt - 10m	3

 14248
 14249



NEW
ARRIVAL

ΛΑΜΠΑ LED E14 ΚΕΡΑΚΙ

		
14248	5.2W 470Lm - θερμό 3000K - S16591	5
14249	5.2W 480Lm - ψυχρό 6500K - S16593	5

 14250
 14251



NEW
ARRIVAL

ΛΑΜΠΑ LED E14 ΣΦΑΙΡΙΚΗ

		
14250	5.2W 470Lm - θερμό 3000K - S16579	5
14251	5.2W 480Lm - ψυχρό 6500K - S16581	5

 14252
 14253



NEW
ARRIVAL

ΛΑΜΠΑ LED E27 ΣΦΑΙΡΙΚΗ

		
14252	5.2W 470Lm - θερμό 3000K - S16577	5
14253	5.2W 480Lm - ψυχρό 6500K - S16578	5





NEW
ARRIVAL

ΛΑΜΠΑ LED E27 B22 GLS BAYONET

		
14257	8.2W 820Lm - λευκό 6500K - S16602	5



14254



14258



14261



14255



14259



14256



14260



ΛΑΜΠΑ LED E27 GLS

Barcode	Icon	Box
14254	8.2W 806Lm - θερμό 3000K - S16603	5
14255	8.2W 820Lm - ημέρας 4000K - S16604	5
14256	8.2W 820Lm - λευκό 6500K - S16605	5
14258	10.5W 1060Lm - θερμό 3000K - S15236	5
14259	10.5W 1060Lm - λευκό 6500K - S15237	5
14260	13.2W 1521Lm - θερμό 3000K - S16609	5
14261	13.2W 1560Lm - λευκό 6500K - S16611	5



NEW ARRIVAL



NEW ARRIVAL

ΛΑΜΠΑ LED E27 R63

Barcode	Icon	Box
14262	7.8W 630Lm - θερμό 3000K - S16615	5



14263



14264



NEW ARRIVAL

ΛΑΜΠΑ LED GU 10 SPOT

Barcode	Icon	Box
14263	4.2W 345Lm - θερμό 3000K - S16569	5
14264	4.2W 370Lm - ημέρας 4000K - S16570	5



14265



14267

PHILIPS



NEW ARRIVAL

ΜΠΑΤΑΡΙΕΣ ΑΛΚΑΛΙΚΕΣ POWER ALKALINE (4 PACK)

Barcode	Icon	Box
14265	1.5V - AA - LR6P4B	24
14267	1.5V - AAA - LR03P4B	24



PHILIPS



NEW ARRIVAL

ΜΠΑΤΑΡΙΕΣ ΑΛΚΑΛΙΚΕΣ POWER ALKALINE (2 PACK)

Barcode	Icon	Box
14269	1.5V - C - LR14P2B	12



PHILIPS



NEW
ARRIVAL

ΜΠΑΤΑΡΙΕΣ ΑΛΚΑΛΙΚΕΣ POWER ALKALINE (2 PACK)

14270	1.5V - D - LR20P2B	12



PHILIPS



NEW
ARRIVAL

ΜΠΑΤΑΡΙΑ ΑΛΚΑΛΙΚΗ POWER ALKALINE

14271	9V - LR61P1B	12



14266



14268

PHILIPS

ΜΠΑΤΑΡΙΕΣ ΨΕΥΔΑΡΓΥΡΟΥ LONG LIFE (10 PACK)

14266	1.5V - AA - R6L10BP	24
14268	1.5V - AAA - R03L10BP	24



NEW
ARRIVAL



Kodak



NEW
ARRIVAL

ΦΑΚΟΣ ΑΔΙΑΒΡΟΧΟΣ LED + 3 ΜΠΑΤΑΡΙΕΣ ΑΑΑ

14953	9 λυχνίες, 46Lm, 25m εμβέλεια	12



02730



00335



ΦΑΚΟΣ ΑΔΙΑΒΡΟΧΟΣ

02730	Μικρός (XK201)	12
00335	Μεγάλος (XK203)	12



ΚΟΦΤΗΣ ΚΑΛΩΔΙΩΝ

15224	600mm	1



ΚΟΦΤΗΣ ΚΑΛΩΔΙΩΝ

15225	250mm	6



09284



09285



09286



ΚΡΟΚΟΔΕΙΛΑΚΙΑ

09284	11cm	10
09285	14cm	10
09286	18cm	10



03242



01273



ΑΚΡΟΔΕΚΤΗΣ ΜΕ ΚΑΛΩΔΙΑ

03242	300Amp	1
01273	500Amp	1



02082



02511



ΑΤΣΑΛΙΝΑ ΗΛΕΚΤΡΟΛΟΓΩΝ

02082	5m	10
02511	10m	10



ΑΤΣΑΛΙΝΑ ΝΑΪΛΟΝ ΗΛΕΚΤΡΟΛΟΓΩΝ

02517	10m	5

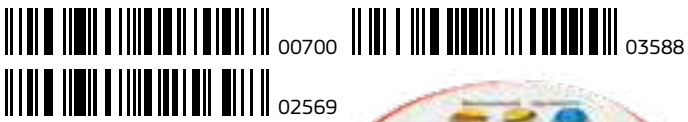

WETEC



ΚΟΛΛΗΣΗ ΡΟΛΟ 250gr

Barcode	Icon	Icon
00700	☑	📦 10
02569	☑	📦 10
03588	☑	📦 5



ΣΟΛΑΝΤΕΡΙΝΗ

Barcode	Icon	Icon
01304	☑	📦 5

50gr



ΚΟΛΛΗΤΗΡΙΑ ΗΛΕΚΤΡΙΚΟ ΠΙΣΤΟΛΙ ΒΑΡΕΩΣ ΤΥΠΟΥ 05C

Barcode	Icon	Icon
07396	☑	📦 1

250W



NEW
ARRIVAL

ΚΟΛΛΗΤΗΡΙΑ ΗΛΕΚΤΡΙΚΟ ΣΤΥΛΟ WLE6023C

Barcode	Icon	Icon
15027	☑	📦 1

60W - LED



ΚΟΛΛΗΤΗΡΙΑ ΗΛΕΚΤΡΙΚΟ ΠΙΣΤΟΛΙ ΜΕ 6 ΜΥΤΕΣ ΤΒ100ΕΥ

Barcode	Icon	Icon
07697	☑	📦 1

130W

	09177		09189
	09178		09191
	09179		09192
	09180		09193
	09181		14992
	09182		09195
	09183		09196
	09184		09197
	09185		09174
	09186		09175
	09187		



ΡΟΚΑ ΣΤΡΟΓΓΥΛΟ

09177	5/20mm	100
09178	6/25mm	100
09179	6/35mm	100
09180	7/25mm	100
09181	7/35mm	100
09182	8/25mm	100
09183	8/35mm	100
09184	9/25mm	100
09185	9/35mm	100
09186	10/25mm	100
09187	10/35mm	100
09189	12/35mm	100
09191	14/35mm	100
09192	14/45mm	100
09193	15/45mm	100
14992	16/45mm	50
09195	17/45mm	50
09196	19/45mm	50
09197	22/45mm	50



ΡΟΚΑ ΠΛΑΚΕ

09174	4/20mm	100
09175	5/20mm	100



ΕΚΘΕΤΗΡΙΟ ΔΕΜΑΤΙΚΩΝ

15326	100x50x215mm	5

	12539		12551		12562		12574
	12540		12552		12563		12575
	12541		12553		12564		12576
	12542		12554		12565		12577
	12543		12555		12566		12578
	12544		12556		12567		12579
	12545		12557		12568		12580
	12546		12558		12569		12581
	12547		12559		12570		12582
	12548		12560		12571		12583
	12549		12561		12572		12584
	12550				12573		



GET IT NOW
HOT SELLER

ΔΕΜΑΤΙΚΑ ΚΑΛΩΔΙΩΝ ΑΣΠΡΑ

12539	2,5x100mm (πλάτος X μήκος)	100άδα 5
12540	2,5x135mm (πλάτος X μήκος)	100άδα 5
12541	2,5x160mm (πλάτος X μήκος)	100άδα 5
12542	2,5x200mm (πλάτος X μήκος)	100άδα 5
12543	3,5x140mm (πλάτος X μήκος)	100άδα 5
12544	3,5x200mm (πλάτος X μήκος)	100άδα 5
12545	3,5x250mm (πλάτος X μήκος)	100άδα 5
12546	3,5x280mm (πλάτος X μήκος)	100άδα 5
12547	4,5x200mm (πλάτος X μήκος)	100άδα 5
12548	4,5x250mm (πλάτος X μήκος)	100άδα 5
12549	4,5x280mm (πλάτος X μήκος)	100άδα 5
12550	4,5x360mm (πλάτος X μήκος)	100άδα 5
12551	4,5x430mm (πλάτος X μήκος)	100άδα 5
12552	7,5x280 mm(πλάτος X μήκος)	100άδα 5
12553	7,5x360mm (πλάτος X μήκος)	100άδα 5
12554	7,5x450mm (πλάτος X μήκος)	100άδα 5
12555	7,5x500mm (πλάτος X μήκος)	100άδα 5
12556	7,5x750mm (πλάτος X μήκος)	100άδα 5
12557	9,0x550mm (πλάτος X μήκος)	100άδα 5
12558	9,0x780mm (πλάτος X μήκος)	100άδα 5
12559	9,0x920mm (πλάτος X μήκος)	100άδα 5
12560	12,5x500mm (πλάτος X μήκος)	50άδα 5
12561	12,5x750mm (πλάτος X μήκος)	50άδα 5

ΔΕΜΑΤΙΚΑ ΚΑΛΩΔΙΩΝ ΜΑΥΡΑ

12562	2,5x100mm (πλάτος X μήκος)	100άδα 5
12563	2,5x135mm (πλάτος X μήκος)	100άδα 5
12564	2,5x160mm (πλάτος X μήκος)	100άδα 5
12565	2,5x200mm (πλάτος X μήκος)	100άδα 5
12566	3,5x140mm (πλάτος X μήκος)	100άδα 5
12567	3,5x200mm (πλάτος X μήκος)	100άδα 5
12568	3,5x250mm (πλάτος X μήκος)	100άδα 5
12569	3,5x280mm (πλάτος X μήκος)	100άδα 5
12570	4,5x200mm (πλάτος X μήκος)	100άδα 5
12571	4,5x250mm (πλάτος X μήκος)	100άδα 5
12572	4,5x280mm (πλάτος X μήκος)	100άδα 5
12573	4,5x360mm (πλάτος X μήκος)	100άδα 5
12574	4,5x430mm (πλάτος X μήκος)	100άδα 5
12575	7,5x280 mm(πλάτος X μήκος)	100άδα 5
12576	7,5x360mm (πλάτος X μήκος)	100άδα 5
12577	7,5x450mm (πλάτος X μήκος)	100άδα 5
12578	7,5x500mm (πλάτος X μήκος)	100άδα 5
12579	7,5x750mm (πλάτος X μήκος)	100άδα 5
12580	9,0x550mm (πλάτος X μήκος)	100άδα 5
12581	9,0x780mm (πλάτος X μήκος)	100άδα 5
12582	9,0x920mm (πλάτος X μήκος)	100άδα 5
12583	12,5x500mm (πλάτος X μήκος)	50άδα 5
12584	12,5x750mm (πλάτος X μήκος)	50άδα 5



ΠΙΣΤΟΛΙ ΔΕΜΑΤΙΚΩΝ ΣΕΤ ΤΑΪΒΑΝ

05823		6



07436

03140



ΑΝΑΡΤΗΡΑΣ ΝΤΟΥΛΑΠΙΩΝ ΙΣΙΟΣ

Barcode	Icon	Quantity
07436	E.T. No50	200
03142	E.T. No60	200
03140	E.T. No80	200
00281	E.T. No100	200



00125

01954



ΑΝΑΡΤΗΡΑΣ ΝΤΟΥΛΑΠΙΩΝ ΤΑΦ

Barcode	Icon	Quantity
00125	B.T.	150
01954	E.T.	100



ΣΤΟΠΕΡ ΡΟΛΩΝ ΓΩΝΙΑ

Barcode	Icon	Quantity
02621		100



10070

02338

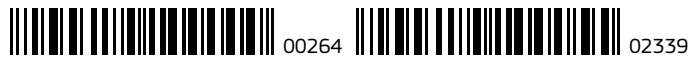

00264

02339



00265

14597



00266

14598

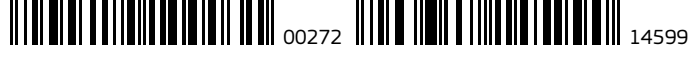

00272

14599



GET IT NOW

ΓΩΝΙΑ ΜΑΡΑΓΚΩΝ ΝΙΚΕΛ

Barcode	Icon	Quantity
10070	20x20mm	200
00264	30x30mm	100
00265	40x40mm	100
00266	50x50mm	100
00272	60x60mm	100
02338	80x80mm	100
02339	100x100mm	100

ΓΩΝΙΑ ΜΑΡΑΓΚΩΝ ΙΝΟΧ

Barcode	Icon	Quantity
14597	40x40mm	30
14598	50x50mm	30
14599	60x60mm	100



ΓΩΝΙΑ ΟΒΑΛ

Barcode	Icon	Quantity
01951	50x50mm	100



ΛΑΜΑΚΙ ΣΥΝΔΕΣΕΩΝ ΜΑΡΑΓΚΩΝ ΓΑΛΒΑΝΙΖΕ

Barcode	Icon	Quantity
06891		60 x 16 x 1,5mm 100
04727		80 x 16 x 1,5mm 100
04728		100 x 16 x 2,0mm 100
04729		120 x 25 x 2,0mm 100
01255		160 x 25 x 2,0mm 100
04754		200 x 25 x 2,5mm 100



ΓΩΝΙΑ ΝΕΥΡΟΥ

Barcode	Icon	Quantity
00269		50x60mm 100



ΜΙΛΙΑ ΚΡΕΒΑΤΙΩΝ

Barcode	Icon	Quantity
10153		3 δόντια 10



ΣΧΑΡΑΚΙ ΕΞΑΕΡΙΣΜΟΥ 150X150mm

Barcode	Icon	Quantity
14107		Καφέ σκούρο 50
14104		Κίτρινο 50
14103		Λευκό 50
14108		Μαύρο 50
14106		Μπεζ 50
14105		Νίκελ 50



ΠΟΔΙΑ ΝΤΟΥΛΑΠΙΩΝ

Barcode	Icon	Quantity
10656		7cm Λεπτό σπείρωμα 200
05624		10cm Λεπτό σπείρωμα 150
10579		10cm Χοντρό σπείρωμα 250
06553		15cm Λεπτό σπείρωμα 100



13352

13351

ΦΟΥΡΚΕΤΑ

Barcode	Icon	Icon
13351	Μεγάλη	100
13352	Μικρή	100



ΓΩΝΙΑ ΡΑΦΙΟΥ

Barcode	Icon	Icon
00257	100x125mm (4x5")	20
00258	125x150mm (5x6")	20
00259	150x200mm (6x8")	20
00260	200x250mm (8x10")	20
00261	250x300mm (10x12")	20
02145	300x350mm (12x14")	20
02110	350x400mm (14x16")	10
06256	400x450mm (16x18")	10



ΣΤΗΡΙΓΜΑ ΣΩΛΗΝΩΝ ΝΤΟΥΛΑΠΑΣ (ΠΕΤΑΛΟ)

Barcode	Icon	Icon
13043	Λευκό	200

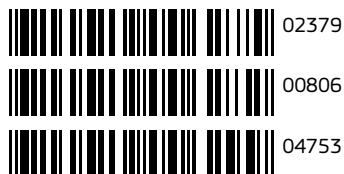

ΓΩΝΙΑ ΡΑΦΙΟΥ ΓΑΛΒΑΝΙΖΕ ΒΑΡΕΩΣ ΤΥΠΟΥ

Barcode	Icon	Icon
02379	200x300mm	10
00806	250x400mm	10
04753	330x500mm	10



ΓΩΝΙΑ ΚΡΥΣΤΑΛΛΩΝ ΠΤΥΣΣΟΜΕΝΗ

Barcode	Icon	Icon
00254	130-180mm	12
00255	150-250mm	12
00256	200-300mm	12

14399 14401
14400

DOMUS

NEW ARRIVAL

ΣΟΥΣΤΑ ΠΟΡΤΑΣ 40-80Kg (ΤΥΠΟΥ CISA)

Barcode	Color	Weight	Quantity
14399	Ασημί (S110Z)	1	1
14400	Λευκή (S110L)	1	1
14401	Μαύρη (S110M)	1	1

14402 14404
14403

DOMUS

NEW ARRIVAL

ΣΟΥΣΤΑ ΠΟΡΤΑΣ 40-80Kg (ΤΥΠΟΥ YALE)

Barcode	Color	Weight	Quantity
14402	Ασημί (S120Z)	1	1
14403	Λευκή (S120L)	1	1
14404	Μαύρη (S120M)	1	1

Barcode

ΣΟΥΣΤΑ ΜΠΡΑΤΣΟΥ

Barcode	Dimensions	Quantity
03975	90x250mm	10

03976 13167

MARTIN

ΣΟΥΣΤΑ ΠΟΡΤΑΣ

Barcode	Weight	Code	Quantity
03976	45-60Kg	code 08900	1
13167	60-80Kg	code 08902	1



14807
14808



ΜΕΝΤΕΣΕΣ ΒΑΡΕΩΣ ΤΥΠΟΥ ΙΡΙΔΙΟΥ ΤΕΤΡΑΓΩΝΟΣ

Barcode	Icon	Quantity
14807		2 1/2" x 2 1/2" 1
14808		3" x 3" 1



14810



ΜΕΝΤΕΣΕΣ ΤΕΤΡΑΓΩΝΟΣ ΓΑΛΒΑΝΙΖΕ

Barcode	Icon	Quantity
14810		2 1/2" x 2 1/2" 48

12644
08863
03505
03506
03507





ΜΕΝΤΕΣΕΣ ΒΑΡΕΩΣ ΤΥΠΟΥ ΚΙΤΡΙΝΟΣ ΤΕΤΡΑΓΩΝΟΣ

HOT SELLER
GET IT NOW

Barcode	Icon	Quantity
12644		2" x 2" x 1,2mm - code 93120 5
08863		2 1/2" x 2 1/2" x 1,3mm - code 93122 5
03505		3" x 3" x 1,8mm - code 93124 5
03506		3 1/2" x 3 1/2" x 2mm - code 93126 5
03507		4" x 4" x 2mm - code 93128 5

02920
02921
02922
02923

ΜΕΝΤΕΣΕΣ ΚΙΤΡΙΝΟΣ

Barcode	Icon	Quantity
02920		1 1/2" - code 93222 12
02921		2" - code 93224 12
02922		2 1/2" - code 93226 12
02923		3" - code 93228 12

13902
11465
13903
11473



ΜΕΝΤΕΣΕΣ ΙΝΟΧ

Barcode	Icon	Quantity
13902		40x40mm 25
11465		40x60mm 25
13903		50x80mm 20
11473		60x80mm 25

09325
09327
09326
09328

ΜΕΝΤΕΣΕΣ ΜΑΥΡΟΣ





Barcode	Icon	Quantity
09325		1 1/2" - code 93202 12
09327		2" - code 93204 12
09326		2 1/2" - code 93206 12
09328		3" - code 93208 12

 00892  10082
 00893  10083

 10082

ΜΑΣΚΟΥΛΟ

Barcode	Material	Quantity
00892	8" Γαλβανιζέ	12
00893	10" Γαλβανιζέ	12
10082	8" Μαύρο	12
10083	10" Μαύρο	12

 01919
 00909
 05425



ΜΕΝΤΕΣΕΣ ΤΑΦ ΙΡΙΔΙΟΥ

Barcode	Material	Quantity
01919	3"	24
00909	4"	24
05425	5"	24

ΜΕΝΤΕΣΕΣ ΕΞΑΦΥΛΛΩΝ

Barcode	Material	Quantity
00899	50x130mm	24

ΜΕΝΤΕΣΕΣ ΜΑΚΡΟΣΤΕΝΟΣ 3/4

Barcode	Material	Quantity
02075	20x74mm	48

 14805
 14806
 14818



ΜΕΝΤΕΣΕΣ ΔΙΠΛΟΣ

Barcode	Material	Quantity
14805	3"	24
14806	4"	24
14818	5"	24

 07331
 05506
 05507
 05508



ΟΔΗΓΟΣ ΔΑΠΕΔΟΥ ΝΑΥΛΟΝ ΛΕΥΚΟΣ

Barcode	Material	Quantity
07331	083.3040	10



ΟΔΗΓΟΣ ΠΛΑΣΤΙΚΟΣ ΣΥΡΟΜΕΝΗΣ ΠΟΡΤΑΣ

Barcode	Material	Quantity
05506	080.2538	20
05507	080.3038	20
05508	080.4060	15

06328
07153
09002



ΡΑΓΕΣ

06328	No100 - code 100.100	6m
07153	No300 - code 100.300	6m
09002	No400 - code 100.400	6m



ΦΑΡΟΣ ΗΛΕΚΤΡΟΝΙΚΟΣ LED FL10

13341	code 320.018	1



ΣΤΗΡΙΓΜΑ ΟΡΟΦΗΣ ΓΙΑ ΡΑΓΑ Νο100

13885	code 100.140	1



ΟΔΗΓΟΣ ΚΙΝΗΣΗΣ 1m

13342	11x30mm - code 311.1230	1

07332
07333



ΒΑΣΗ ΡΥΘΜΙΖΟΜΕΝΗ ΧΩΡΙΣ ΠΛΑΣΤΙΚΟΥΣ ΟΔΗΓΟΥΣ

07332	Μονή - code 100.611	10
07333	Διπλή - code 100.612	10



ΜΟΤΕΡ ΣΥΡΟΜΕΝΗΣ ΠΟΡΤΑΣ DM850

13340	code 320.000	1



ΡΑΟΥΛΟ ΜΕ ΒΑΣΗ ΧΩΝΕΥΤΟ - ΓΩΝΙΑ

Barcode	Dimensions	Code	Quantity
05554	Φ80mm	code 155.820	4

05617

05663

06088



ΡΑΟΥΛΟ ΜΕ ΒΑΣΗ ΒΙΔΩΤΟ - ΓΩΝΙΑ

Barcode	Dimensions	Code	Quantity
05617	Φ60mm	code 154.617	6
05663	Φ80mm	code 154.820	4
06088	Φ100mm	code 154.1020	4

13162

13163

13164

13165

13166



ΡΑΟΥΛΟ ΜΕ ΒΑΣΗ ΒΙΔΩΤΟ - ΓΩΝΙΑ

Barcode	Dimensions	Code	Quantity
13162	Φ50mm	code 93342	6
13163	Φ60mm	code 93343	6
13164	Φ70mm	code 93344	6
13165	Φ80mm	code 93345	4
13166	Φ100mm	code 93347	4

05542

05559

05543

06089

06090



ΡΑΟΥΛΟ ΜΕ ΒΙΔΑ 1 ΡΟΥΛΕΜΑΝ - ΓΩΝΙΑ

Barcode	Dimensions	Code	Quantity
05542	Φ60mm	code 151.617	10
05559	Φ70mm	code 151.717	10
05543	Φ80mm	code 151.820	6
06089	Φ100mm	code 151.1020	6
06090	Φ120mm	code 151.1222	6

13157

13158

13159

13160

13161



ΡΑΟΥΛΟ ΜΕ ΒΙΔΑ 1 ΡΟΥΛΕΜΑΝ - ΓΩΝΙΑ

Barcode	Dimensions	Code	Quantity
13157	Φ60mm	code 93328	10
13158	Φ70mm	code 93329	10
13159	Φ80mm	code 93330	6
13160	Φ100mm	code 93332	6
13161	Φ120mm	code 93333	4

08276

08959



ΡΑΟΥΛΟ ΜΕ ΒΑΣΗ ΒΙΔΩΤΟ - ΣΤΡΟΓΓΥΛΟ

Barcode	Dimensions	Code	Quantity
08276	Φ60mm	code 154.61702	6
08959	Φ80mm	code 154.82002	4



05537



05515



05541



05665



06977

DELTA



ΡΑΟΥΛΟ ΜΕ ΠΛΑΪΝΗ ΒΑΣΗ 1 ΡΟΥΛΕΜΑΝ - ΓΩΝΙΑ

Barcode	Product Code	Code	Quantity
	05537	Φ60mm - code 150.617	8
	05515	Φ70mm - code 150.717	8
	05541	Φ80mm - code 150.820	6
	05665	Φ100mm - code 150.1020	4
	06977	Φ120mm - code 150.1222	2



10012



10013



10014



10015



13156

M MARTIN
LIFTING SOLUTIONS

ΡΑΟΥΛΟ ΜΕ ΠΛΑΪΝΗ ΒΑΣΗ 1 ΡΟΥΛΕΜΑΝ - ΓΩΝΙΑ

Barcode	Product Code	Code	Quantity
	10012	Φ60mm - code 93360	8
	10013	Φ70mm - code 93362	6
	10014	Φ80mm - code 93364	4
	10015	Φ100mm - code 93366	4
	13156	Φ120mm - code 93368	4



08130



08131



09015

DELTA



ΡΑΟΥΛΟ ΜΕ ΠΛΑΪΝΗ ΒΑΣΗ 1 ΡΟΥΛΕΜΑΝ - ΣΤΡΟΓΓΥΛΟ

Barcode	Product Code	Code	Quantity
	08130	Φ70mm - code 150.71702	8
	08131	Φ80mm - code 150.82002	6
	09015	Φ100mm - code 150.10202	4



DELTA



ΡΑΟΥΛΟ ΓΙΑ ΣΥΡΜΑΤΟΣΧΟΙΝΟ

Barcode	Product Code	Code	Quantity
	08574	Φ60mm - code 151.6602	10



11362



11363



ΡΑΟΥΛΟ ΙΝΟΧ ΣΤΡΟΓΓΥΛΟ

Barcode	Product Code	Code	Quantity
	11362	Φ25mm	5
	11363	Φ32mm	5



DELTA



ΡΑΟΥΛΟ ΚΥΛΙΣΗΣ ΓΙΑ ΓΕΡΑΝΟ

Barcode	Product Code	Code	Quantity
	13339	20.80100	1

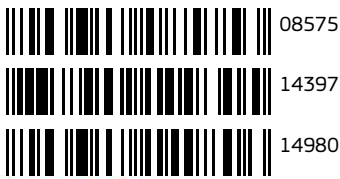

DELTA



ΒΑΣΗ ΓΙΑ ΡΑΟΥΛΑ ΜΕ ΒΙΔΑ

Barcode	Description	Quantity
08575	Φ60mm - code 153.600	10
14397	Φ70mm - code 153.700	10
14980	Φ80mm - code 153.800	10

NEW
ARRIVAL



DELTA



ΛΑΜΑ ΜΕ ΠΑΣΟ ΓΙΑ ΣΥΓΚΟΛΛΗΣΗ

Barcode	Description	Quantity
13883	No100 - code 100.116	1
13884	No300 - code 100.316	1

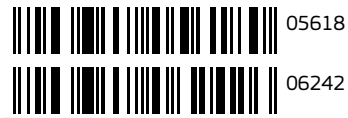

DELTA



ΡΑΟΥΛΟ ΜΟΝΟΖΕΥΓΟ

Barcode	Description	Quantity
05618	No100 - code 100.111	30
06242	No300 - code 100.311	30

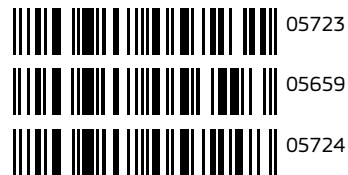

DELTA



ΡΑΟΥΛΟ ΔΙΠΛΟΖΕΥΓΟ

Barcode	Description	Quantity
05723	No100 - code 100.110	50
05659	No300 - code 100.310	30
05724	No400 - code 100.410	20

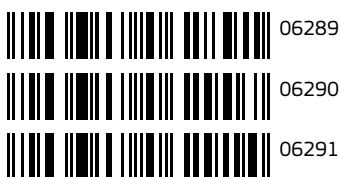

DELTA



ΜΕΝΤΕΣΕΣ ΜΠΙΛΙΑΣ

Barcode	Description	Quantity
06289	20x90mm (Φ x ύψος) - code 290.120	30
06290	25x110mm (Φ x ύψος) - code 290.125	15
06291	30x130mm (Φ x ύψος) - code 290.130	10



DELTA



ΜΕΝΤΕΣΕΣ ΜΠΙΛΙΑΣ ΣΤΡΟΓΓΥΛΟ ΚΕΦΑΛΙ

Barcode	Description	Quantity
05510	30x130mm (Φ x ύψος) - code 295.130	10



ΜΕΝΤΕΣΕΣ ΣΙΔΗΡΟΥΡΓΩΝ

Barcode	Code	Size	Code	Quantity
00900	00900	Φ12mm	code 93412	40
00901	00901	Φ14mm	code 93414	30
00902	00902	Φ16mm	code 93416	20
00903	00903	Φ18mm	code 93418	20
00904	00904	Φ20mm	code 93420	15
00905	00905	Φ22mm	code 93422	15
00906	00906	Φ25mm	code 93425	10
01473	01473	Φ30mm	code 93430	10



ΜΕΝΤΕΣΕΣ ΓΩΝΙΑ

Barcode	Code	Size	Code	Quantity
08503	08503	25x112mm (Φ x ύψος)	code 230.225	40



ΜΕΝΤΕΣΕΣ ΜΟΝΟΠΤΕΡΟΣ (ΜΕΓΑΛΗ ΠΛΕΥΡΑ)

Barcode	Code	Size	Code	Quantity
09879	09879	12x60mm (Φ x ύψος)	code 240.212	50
09880	09880	14x66mm (Φ x ύψος)	code 240.214	40
09881	09881	16x70mm (Φ x ύψος)	code 240.216	40
09882	09882	18x76mm (Φ x ύψος)	code 240.218	40
09677	09677	20x82mm (Φ x ύψος)	code 240.220	30
09678	09678	25x112mm (Φ x ύψος)	code 240.225	50
09883	09883	30x112mm (Φ x ύψος)	code 240.230	30



ΜΕΝΤΕΣΕΣ ΜΟΝΟΠΤΕΡΟΣ ΓΑΛΒΑΝΙΖΕ (ΜΕΓΑΛΗ ΠΛΕΥΡΑ)

Barcode	Code	Size	Code	Quantity
13913	13913	12x60mm (Φ x ύψος)	code 02.240.212	50
13914	13914	14x66mm (Φ x ύψος)	code 02.240.214	40
13915	13915	16x70mm (Φ x ύψος)	code 02.240.216	40
13916	13916	18x76mm (Φ x ύψος)	code 02.240.218	40
13917	13917	20x82mm (Φ x ύψος)	code 02.240.220	30
13918	13918	25x112mm (Φ x ύψος)	code 02.240.225	50
13919	13919	30x112mm (Φ x ύψος)	code 02.240.230	30



DELTA



ΜΕΝΤΕΣΕΣ ΔΙΠΤΕΡΟΣ

Barcode	Code	Quantity
01079	12x60mm (Φ x ύψος) - code 250.212	50
01063	14x65mm (Φ x ύψος) - code 250.214	40
00600	16x70mm (Φ x ύψος) - code 250.216	40
01372	18x75mm (Φ x ύψος) - code 250.218	40
02324	20x82mm (Φ x ύψος) - code 250.220	30
00818	25x110mm (Φ x ύψος) - code 250.225	50
03440	30x110mm (Φ x ύψος) - code 250.230	30



MARTIN
LIFT SYSTEMS

ΜΕΝΤΕΣΕΣ ΔΙΠΤΕΡΟΣ

Barcode	Code	Quantity
11466	Φ12mm - code 93512	40
11467	Φ14mm - code 93514	30
11468	Φ16mm - code 93516	20
11469	Φ18mm - code 93518	20
11470	Φ20mm - code 93520	15
11471	Φ25mm - code 93525	10
11472	Φ30mm - code 93530	10



NEW
ARRIVAL

ΡΟΔΑ ΣΤΑΘΕΡΗ (RUBBER)

Barcode	Code	Quantity
15178	75mm	2
15179	85mm	2
15180	100mm	2
15181	125mm	1
15182	160mm	1
15297	200mm	1

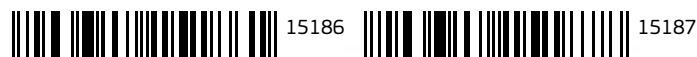

NEW
ARRIVAL

ΡΟΔΑ ΣΤΑΘΕΡΗ (PVC)

Barcode	Code	Quantity
15186	50mm	4
15187	65mm	4



NEW
ARRIVAL

ΡΟΔΑ ΠΕΡΙΣΤΡΕΦΟΜΕΝΗ ΔΙΠΛΗ ΜΕ ΦΡΕΝΟ (TPR)

Barcode	Code	Quantity
15189	50mm	2

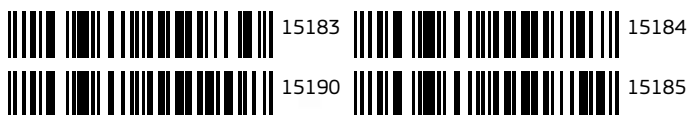

15183

15184



15190

15185



NEW ARRIVAL

ΡΟΔΑ ΠΕΡΙΣΤΡΕΦΟΜΕΝΗ (PVC)

Barcode	Size	Quantity
15183	50mm	4
15190	65mm	4
15184	75mm	2
15185	100mm	2



NEW ARRIVAL

ΡΟΔΑ ΠΕΡΙΣΤΡΕΦΟΜΕΝΗ ΔΙΠΛΗ (PVC)

Barcode	Size	Quantity
15192	50mm	2



NEW ARRIVAL

ΡΟΔΑ ΠΕΡΙΣΤΡΕΦΟΜΕΝΗ ΜΕ ΦΡΕΝΟ ΒΑΡΕΩΣ ΤΥΠΟΥ (PU)

Barcode	Size	Quantity
15193	100mm	1



09446

03794

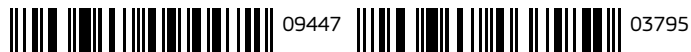

09447

03795

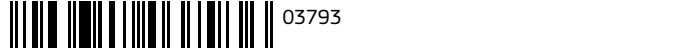

03793



ΡΟΔΑ ΕΠΙΠΛΩΝ ΠΕΡΙΣΤΡΕΦΟΜΕΝΗ

Barcode	Size	Quantity
09446	25mm	16
09447	30mm	16
03793	40mm	4
03794	50mm	4
03795	65mm	4



15298

07709



15299

07710

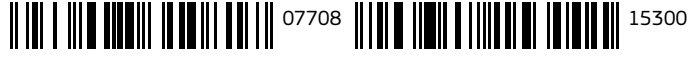

07708

15300



NEW ARRIVAL

ΡΟΔΑ ΠΕΡΙΣΤΡΕΦΟΜΕΝΗ ΜΕ ΦΡΕΝΟ (RUBBER)



Barcode	Size	Quantity
15298	75mm	4
15299	85mm	4
07708	100mm	4
07709	125mm	4
07710	160mm	2
15300	200mm	1

	04292		04295
	04293		15194
	04294		15296



NEW
ARRIVAL



ΡΟΔΑ ΠΕΡΙΣΤΡΕΦΟΜΗΝΗ (RUBBER)

		
04292	75mm	4
04293	85mm	4
04294	100mm	4
04295	125mm	2
15194	160mm	1
15296	200mm	1



NEW
ARRIVAL

ΡΟΔΑ ΠΕΡΙΣΤΡΕΦΟΜΗΝΗ ΒΑΡΕΩΣ ΤΥΠΟΥ (PU)

		
00858	100mm	2





03150



03151





ΚΑΤΕΒΑΤΗΣ

		
03150	No3	50
03151	No4	50





ΚΑΤΕΒΑΤΗΣ ΜΠΑΟΥΛΩΝ

		
11619		50



ΚΑΤΕΒΑΤΗΣ INOX

		
10126	100x28mm	12



DOMUS



ΑΕΡΟΠΛΑΝΑΚΙ

		
04460		25



ΣΥΡΤΗΣ ΣΥΡΟΜΕΝΟΣ

Barcode	Icon	Icon
01316	Γαλβανιζέ	24



09061



09062



ΣΥΡΤΗΣ ΕΛΑΤΗΡΙΟΥ

Barcode	Icon	Icon
09061	150mm - code 120.150	25
09062	200mm - code 120.200	20



06671



02861



02431



02429



02430



04834



ΣΥΡΤΗΣ ΛΟΥΚΕΤΟΥ ΓΑΛΒΑΝΙΖΕ

Barcode	Icon	Icon
06671	120mm - code 93000	12
02429	160mm - code 93002	12
02861	200mm - code 93004	6

Barcode	Icon	Icon
02430	250mm - code 93006	12
02431	300mm - code 93008	12
04834	500mm - code 34.02.06.02	15

GET IT NOW



01309



01326



01310



01327



01309



01326

ΣΥΡΤΗΣ ΠΛΑΚΑ ΟΒΑΛ

Barcode	Icon	Icon
01309	No100	12
01310	No120	12

Barcode	Icon	Icon
01326	Λουκέτου No100	12
01327	Λουκέτου No120	12

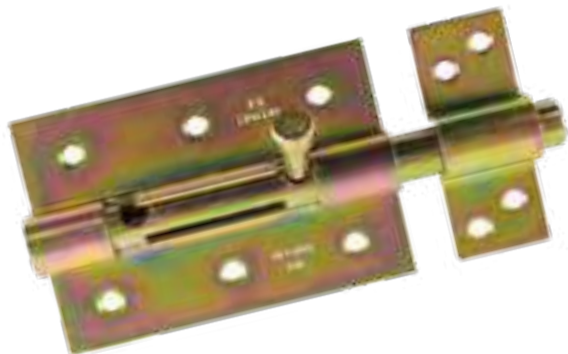

ΣΥΡΤΗΣ ΒΑΡΕΩΣ ΤΥΠΟΥ ΣΤΡΟΓΓΥΛΟΣ ΚΙΤΡΙΝΟΣ

Barcode	Code	Quantity
01147	70mm - code 93600	12
00583	85mm - code 93602	8
01898	100mm - code 93604	8
02243	125mm - code 93606	8

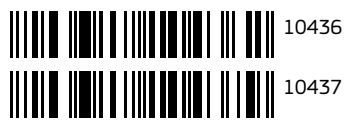

ΣΥΡΤΗΣ ΙΝΟΧ

Barcode	Code	Quantity
10436	50mm	4
10437	75mm	2



ΣΥΡΤΗΣ ΓΚΡΑ

Barcode	Code	Quantity
01498	2½" - 60mm	12



ΣΥΡΤΗΣ ΕΠΙΠΛΩΝ Νο70

Barcode	Code	Quantity
01319	Γώνα	50
01336	Ίσιο	50



ΣΥΡΤΗΣ ΑΛΟΥΜΙΝΙΟΥ ΒΑΡΕΩΣ ΤΥΠΟΥ ΑΣΗΜΙ

Barcode	Code	Quantity
08296	40 x 8mm (μήκος x Φ)	30
08298	60 x 8mm (μήκος x Φ)	25

Barcode	Code	Quantity
08300	80 x 8mm (μήκος x Φ)	20
08302	100 x 8mm (μήκος x Φ)	20



ΣΥΡΤΗΣ ΑΛΟΥΜΙΝΙΟΥ ΒΑΡΕΩΣ ΤΥΠΟΥ ΚΑΦΕ

Barcode	Icon	Volume
08766	40 x 8mm (μήκος x Φ)	30
08767	60 x 8mm (μήκος x Φ)	25
08768	80 x 8mm (μήκος x Φ)	20
08769	100 x 8mm (μήκος x Φ)	20
08770	100 x 12mm (μήκος x Φ)	12
08771	120 x 12mm (μήκος x Φ)	12
08772	150 x 12mm (μήκος x Φ)	12
08773	200 x 12mm (μήκος x Φ)	10



ΣΥΡΤΗΣ ΑΛΟΥΜΙΝΙΟΥ ΒΑΡΕΩΣ ΤΥΠΟΥ ΜΑΥΡΟΣ

Barcode	Icon	Volume
12622	40 x 8mm (μήκος x Φ)	30
12623	60 x 8mm (μήκος x Φ)	25
12624	80 x 8mm (μήκος x Φ)	20
12625	100 x 8mm (μήκος x Φ)	20
12626	100 x 12mm (μήκος x Φ)	12
12627	120 x 12mm (μήκος x Φ)	12
12628	150 x 12mm (μήκος x Φ)	12
12629	200 x 12mm (μήκος x Φ)	10

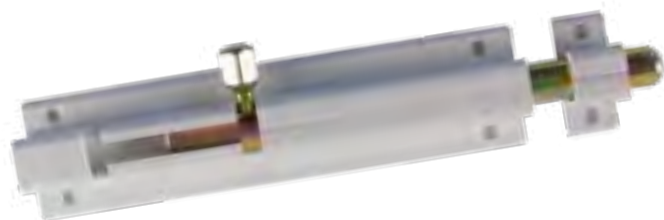
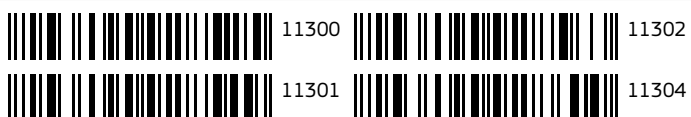

ΣΥΡΤΗΣ ΑΛΟΥΜΙΝΙΟΥ ΒΑΡΕΩΣ ΤΥΠΟΥ ΛΕΥΚΟΣ

Barcode	Icon	Volume
11300	60 x 8mm (μήκος x Φ) - code 92852	10
11301	80 x 8mm (μήκος x Φ) - code 92854	10
11302	100 x 8mm (μήκος x Φ) - code 92856	10
11304	150 x 12mm (μήκος x Φ) - code 92860	10



ΣΥΡΤΗΣ ΑΛΟΥΜΙΝΙΟΥ ΒΑΡΕΩΣ ΤΥΠΟΥ ΛΕΥΚΟΣ

Barcode	Icon	Volume
08295	40 x 8mm (μήκος x Φ)	30
08297	60 x 8mm (μήκος x Φ)	25
08299	80 x 8mm (μήκος x Φ)	20
08301	100 x 8mm (μήκος x Φ)	20
07596	100 x 12mm (μήκος x Φ)	12
07595	120 x 12mm (μήκος x Φ)	12
07981	150 x 12mm (μήκος x Φ)	12
05290	200 x 12mm (μήκος x Φ)	10



ΠΕΛΜΑ Φ ΕΞΩΤΕΡΙΚΟ PVC

Barcode	Code	Quantity
15048	Φ10mm - code 176	1000
07824	Φ12mm - code 121	1000
07825	Φ14mm - code 116	1000
07826	Φ16mm - code 116	1000

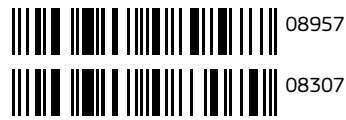

ΠΕΛΜΑ Φ ΕΣΩΤΕΡΙΚΟ

Barcode	Code	Quantity
08957	Φ42mm - 1¼" - code 104	250
08307	Φ48mm - 1½" - code 103	1000



ΠΕΛΜΑ Φ ΕΣΩΤΕΡΙΚΟ

Barcode	Code	Quantity
07119	Φ21mm - 1/2" - code 147	1000

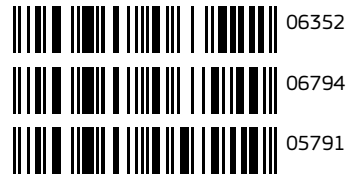

ΠΕΛΜΑ Φ ΕΞΩΤΕΡΙΚΟ PVC

Barcode	Code	Quantity
09198	Φ19mm - 1/2" - code 114	500
06359	Φ21mm - 1/2" - code 112	500
06773	Φ26mm - 3/4" - code 111	500
06355	Φ33mm - 1" - code 189	350

ΠΕΛΜΑ Φ ΕΣΩΤΕΡΙΚΟ ΕΝΙΣΧΥΜΕΝΟ

Barcode	Code	Quantity
06352	Φ42mm - 1¼" - code 104N	250
06794	Φ48mm - 1½" - code 103N	200
05791	Φ60mm - 2" - code 156N	150



ΠΕΛΜΑ Φ ΕΞΩΤΕΡΙΚΟ PVC

Barcode	Code	Quantity
15647	Φ 22mm - code 110	500
13554	Φ25mm - code 109	500
10073	Φ30mm - code 108	400

ΠΕΛΜΑ ΓΙΑ ΜΑΓΚΟΥΡΑ

Barcode	Code	Quantity
10031	Λάστιχο Βακτηριών	20

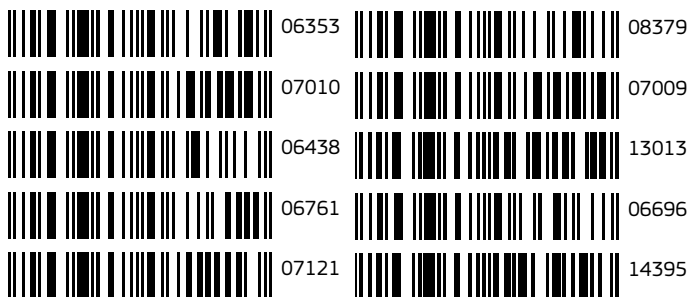

ΠΕΛΜΑ Φ ΕΣΩΤΕΡΙΚΟ

Barcode	Icon	Code	Quantity
06353		Φ10mm - code 138	2000
07010		Φ12mm - code 160	2000
06438		Φ14mm - code 159	2000
06761		Φ16mm - code 132	2000
07121		Φ19mm - code 131	2000
08379		Φ25mm-3/4" - code 128 Ενισχ.	1000
07009		Φ26mm - 3/4" - code 126	1000
13013		Φ28mm - code 180	1000
06696		Φ30mm - 1" - code 149A	500
14395		Φ33mm - 1" - code 149B	500



ΠΕΛΜΑ ΠΑΡΑΛΛΗΛΟΓΡΑΜΜΟ

Barcode	Icon	Code	Quantity
06428		30x20mm - code 244	1000
06656		40x20mm - code 225	500
06658		40x30mm - code 249	400
07976		50x30mm - code 241	400
10992		60x20mm - code 264	300
07205		60x30mm - code 245	250
07975		60x40mm - code 269	200



ΠΕΛΜΑ ΤΕΤΡΑΓΩΝΟ

Barcode	Icon	Code	Quantity
03045		16x16mm - code 242	1000
09392		17x17mm - code 213	1000
07974		20x20mm - code 212	1000
06356		25x25mm - code 209	1000
05244		30x30mm - code 208	500
09071		35x35mm - code 207	250
06548		38x38mm - code 206	250
06311		40x40mm - code 252	250



ΠΕΛΜΑ ΜΕ ΠΤΕΡΥΓΙΟ

Barcode	Icon	Code	Quantity
06439		80x80mm - code 298	50
06679		100x100mm - code 390	40



ΠΕΛΜΑ ΜΕ ΠΤΕΡΥΓΙΟ

Barcode	Icon	Code	Quantity
07325		30x30mm - code 253	500
07324		40x40mm - code 256	250

 09310  14997
 14991
 14710
 

ΠΕΛΜΑ ΜΕ ΠΤΕΡΥΓΙΟ

Barcode	Dimensions - code	Quantity
09310	50x20mm - code 258	500
14991	50x25mm - code 246	300
14710	50x30mm - code 259	300
14997	100x30mm - code 290	150

 06315  09791
 10993  09792
 11096
 

ΠΕΛΜΑ ΜΕ ΠΤΕΡΥΓΙΟ

Barcode	Dimensions - code	Quantity
06315	80x40mm - code 267	150
10993	100x20mm - code 392	100
11096	100x40mm - code 299	100
09791	100x50mm - code 395	100
09792	120x60mm - code 396	50

 07326  08101
 06313
 

ΠΕΛΜΑ ΣΤΑΥΡΟΥ

Barcode	Dimensions - code	Quantity
07326	50x50mm - code 289	200
06313	60x60mm - code 288	150
08101	70x70mm - code 381	50

ΠΕΛΜΑ ΕΣΩΤΕΡΙΚΟ ΠΟΜΠΕ ΜΕ ΠΤΕΡΥΓΙΑ

Barcode	Dimensions - code	Quantity
07959	Ø26mm - 3/4" - code 281	1000



• Αντιμικροβιακή κατεργασία με τεχνολογία ιόντων αργύρου που αναστέλλει κατά 99.9% την ανάπτυξη των μικροβίων διακόπτοντας την αναπαραγωγή τους, με αποτέλεσμα τα μικρόβια να ΜΗΝ μπορούν να πολλαπλασιαστούν. Η διάρκεια αντιμικροβιακής προστασίας της κατεργασίας αυτής είναι για πάντα, για όλη τη διάρκεια ζωής των προϊόντων και δεν επηρεάζεται από πλυσίματα ή άλλα καθαριστικά επιφανειών.



ΑΝΤΙΜΙΚΡΟΒΙΑΚΟ ΠΟΜΟΛΟ EURO ΣΕΤ 6210

Barcode	Color	Quantity
13107	Λευκό (6210L)	2
13108	Μαύρο (6210M)	2
15413	Ασημί (6210S)	2



ΑΝΤΙΜΙΚΡΟΒΙΑΚΟ ΠΟΜΟΛΟ EURO ΣΕΤ 6280 ΜΕΣΟΠΟΡΤΑΣ

Barcode	Color	Quantity
13109	Λευκό (6280L)	2



ΠΟΜΟΛΑ

06165
06166

DOMUS

ΠΟΜΟΛΟ ΣΕΤ 6110

Barcode	Description	Quantity
06165	Λευκό (6110L)	2
06166	Μαύρο (6110M)	2

06167
06168

DOMUS

ΠΟΜΟΛΟ ΜΟΝΟ 6115

Barcode	Description	Quantity
06167	Λευκό (6115L)	2
06168	Μαύρο (6115M)	2

09076
10222

DOMUS

ΠΟΜΟΛΟ ΣΕΤ 6310

Barcode	Description	Quantity
09076	Λευκό (6310L)	5
10222	Μαύρο (6310M)	5

10442
10443

DOMUS

ΠΟΜΟΛΟ ΜΟΝΟ 6315

Barcode	Description	Quantity
10442	Λευκό (6315L)	10
10443	Μαύρο (6315M)	10

13896
13897

DOMUS

ΠΟΜΟΛΟ ΣΕΤ 6150 ΟΒΑΛ

Barcode	Description	Quantity
13896	Λευκό (6150L)	2
13897	Μαύρο (6150M)	2

DOMUS

ΠΟΜΟΛΟ INOX ΣΕΤ 6000

Barcode	Description	Quantity
09091	Inox (6000X)	1

■ NEW ARRIVAL ΝΕΑ ΑΦΙΞΗ ■ HOT SELLER ΚΑΛΥΤΕΡΟ ΣΤΗΝ ΠΩΛΗΣΗ ■ GET IT NOW ΑΞΙΖΕΙ ΝΑ ΑΓΟΡΑΣΕΙΣ ΤΩΡΑ

 13894
 13895



**ΠΟΜΟΛΟ ΣΕΤ 6130
ΜΕ ΟΡΘΟΓΩΝΙΑ ΛΑΒΗ**

		
13894	Λευκό (6130L)	5
13895	Μαύρο (6130M)	5

 10440
 10441



ΠΟΜΟΛΟ ΜΕ ΠΛΑΚΑ ΣΕΤ 6340

		
10440	Λευκό (6340L)	2
10441	Μαύρο (6340M)	2

 09090
 13893



ΠΟΜΟΛΟ ΜΕ ΠΛΑΚΑ ΣΕΤ 6145

		
09090	Λευκό (6145L)	1
13893	Μαύρο (6145M)	1

 10438
 10439



ΠΟΜΟΛΟ ΜΕ ΠΛΑΚΑ ΣΕΤ 6165

		
10438	Λευκό (6165L)	1
10439	Μαύρο (6165M)	1

 11628



ΣΠΑΝΙΟΛΕΤΑ DSL ΟΒΑΛ 7960

		
11628	Λευκό (7960L)	5

 10572
 10612



ΣΠΑΝΙΟΛΕΤΑ ΑΝΟΙΓΟΜΕΝΩΝ 6900

		
10572	Λευκό (6900L)	1
10612	Μαύρο (6900M)	1

NEW ARRIVAL

12654
15036

ΠΟΜΟΛΑ

ΣΠΑΝΙΟΛΕΤΑ ΑΝΟΙΓΟΜΕΝΩΝ ΟΡΘΟΓΩΝΙΑ 6930

Barcode	Color	Quantity
12654	Λευκό (6930L)	1
15036	Μαύρο (6930M)	1

ΠΟΜΟΛΑ

ΣΠΑΝΙΟΛΕΤΑ ΑΝΟΙΓΟΜΕΝΩΝ ΟΒΑΛ 6950

Barcode	Color	Quantity
12655	Λευκό (6950L)	1

NEW ARRIVAL

08791
10536

ΠΟΜΟΛΑ

ΣΠΑΝΙΟΛΕΤΑ DSL ΑΣΦΑΛΕΙΑΣ 180° 790N

Barcode	Color	Quantity
08791	Λευκό (790NL)	5
10536	Μαύρο (790NM)	5

NEW ARRIVAL

15260
08292
07247

ΠΟΜΟΛΑ

ΚΛΕΙΔΑΡΙΑ 3 ΣΗΜΕΙΩΝ ΜΑΧΑΙΡΩΤΗ

Barcode	Material	Quantity
15260	30άρα Νίκελ (94430)	1
08292	35άρα Inox (94435X)	1
07247	35άρα Νίκελ (94435)	1

10573
11516

ΠΟΜΟΛΑ

ΣΠΑΝΙΟΛΕΤΑ DSL 7910

Barcode	Color	Quantity
10573	Λευκό (7910L)	5
11516	Μαύρο (7910M)	5



DOMUS



ΚΛΕΙΔΑΡΙΑ 3 ΣΗΜΕΙΩΝ 35άρα ΓΡΑΝΑΖΩΤΗ TOP GEAR

10693	93635	1



DOMUS



ΚΛΕΙΔΑΡΙΑ 5 ΣΗΜΕΙΩΝ 35άρα ΓΡΑΝΑΖΩΤΗ TOP GEAR

10396	94635	1



00480



04948



05744



09374



04304



04584

DOMUS

ΚΛΕΙΔΑΡΙΑ ΓΛΩΣΣΟΥ ΜΕ ΚΥΛΙΝΔΡΟ

00480	(A) 20mm - κύλινδρος 54mm (90120)	5
05744	(A) 25mm - κύλινδρος 54mm (91125)	5
04304	(A) 30mm - κύλινδρος 75mm (911307K)	5
04948	(A) 30mm - κύλινδρος 83mm (911308K)	5
09374	(A) 35mm - κύλινδρος 75mm (911357K)	5
04584	(A) 35mm - κύλινδρος 83mm (911358K)	5



**HOT
SELLER**



10334	08726	15219
09908	15463	15222
15282	12621	15220
08725	15221	

DOMUS

ΚΛΕΙΔΑΡΙΑ ΓΛΩΣΣΟΥ ΧΩΡΙΣ ΚΥΛΙΝΔΡΟ

10334	(A) 20mm Inox (90120XT)	1
09908	(A) 20mm (91120T)	5
15282	(A) 25mm (91125T)	5
08725	(A) 30mm (91130T)	5
08726	(A) 35mm (91135T)	5
15463	(A) 35mm Inox (91135XT)	1

12621	(A) 35mm EURO 16mm (91735T)	5
15221	(A) 40mm Inox (91140XT)	1
15219	(A) 40mm (91140T)	5
15222	(A) 45mm Inox (91145XT)	1
15220	(A) 45mm (91145T)	5



HOT SELLER
GET IT NOW

01706	13177
-------	-------

DOMUS

ΚΛΕΙΔΑΡΙΑ ΜΠΙΛΙΑΣ ΜΕ ΚΥΛΙΝΔΡΟ

01706	(A) 20mm - κύλινδρος 54mm (90120)	5
13177	(A) 25mm - κύλινδρος 54mm (91125)	5

07769	13178
-------	-------

DOMUS

ΚΛΕΙΔΑΡΙΑ ΜΠΙΛΙΑΣ ΧΩΡΙΣ ΚΥΛΙΝΔΡΟ

07769	(A) 30mm (92130T)	5
13178	(A) 35mm (92135T)	5

DOMUS

ΚΥΠΡΙ ΗΛΕΚΤΡΙΚΟ ΑΠΛΟ

09103	9901F	2

12294	05478	00473
-------	-------	-------

DOMUS

ΚΥΠΡΙ ΗΛΕΚΤΡΙΚΟ ΜΕ ΑΠΑΣΦΑΛΙΣΗ





12294	9904F με αναμονή	2
05478	9902F	2
00473	9902	2

 01713
 05555









ΚΛΕΙΔΑΡΙΑ ΜΑΧΑΙΡΩΤΗ ΜΕ ΚΥΛΙΝΔΡΟ

Barcode	Icon	Icon
01713 (A) 30mm - κύλινδρος 75mm (914307K)	5	
05555 (A) 35mm - κύλινδρος 75mm (914357K)	5	

 13213
 13214



ΚΛΕΙΔΑΡΙΑ ΜΑΧΑΙΡΩΤΗ ΧΩΡΙΣ ΚΥΛΙΝΔΡΟ

Barcode	Icon	Icon
13213 (A) 30mm (91430T)	5	
13214 (A) 35mm (91435T)	5	

 13079
 13080





ΚΛΕΙΔΑΡΙΑ ΓΑΝΤΖΟΥ ΜΕ ΚΥΛΙΝΔΡΟ

Barcode	Icon	Icon
13079 (A) 20mm - κύλινδρος 54mm (95120)	5	
13080 (A) 35mm - κύλινδρος 54mm (95135)	5	

ΚΛΕΙΔΑΡΙΑ ΓΑΝΤΖΟΥ ΜΕ ΚΥΛΙΝΔΡΟ ΟΒΑΛ

Barcode	Icon	Icon
02572 (A) 16mm - κύλινδρος 54mm (95016)	5	

ΚΛΕΙΔΑΡΙΑ ΓΑΝΤΖΟΥ ΧΩΡΙΣ ΚΥΛΙΝΔΡΟ

Barcode	Icon	Icon
06404 (A) 30mm (95030)	5	

 00469
 09393



ΚΛΕΙΔΑΡΙΑ ΕΙΣΟΔΟΥ EXPORT ΜΕ ΚΥΛΙΝΔΡΟ 65mm

Barcode	Icon	Icon
00469 (A) 45mm Ορειχάλ. (90845)	5	
09393 (A) 45mm Χρωμ. (90845CR)	5	

 13528



ΚΛΕΙΔΑΡΙΑ ΕΙΣΟΔΟΥ EXPORT ΟΒΑΛ ΜΕ ΚΥΛΙΝΔΡΟ 65mm

Barcode	Icon	Icon
13528 (A) 45mm Ορειχάλ. (92845)	5	



DOMUS



ΚΛΕΙΔΑΡΙΑ ΕΙΣΟΔΟΥ EXPORT ΧΩΡΙΣ ΚΥΛΙΝΔΡΟ

10367	(A) 45mm Ορειχάλ. (90845T)	5



12524



09124



08326

DOMUS



ΚΛΕΙΔΑΡΙΑ ΤΡΙΑΙΝΑ ΟΡΕΙΧΑΛΚΙΝΗ

12524	(A) 45mm - κύλινδρος 65mm Econ (905EC)	1
09124	(A) 45mm - κύλινδρος 65mm Απλή (9054C)	1
08326	(A) 45mm - κύλινδρος 60mm Plus (905PL)	1



00957



00468



08750



02399

DOMUS



ΚΛΕΙΔΑΡΙΑ ΜΕΣΟΠΟΡΤΑΣ ΟΡΕΙΧΑΛΚΙΝΗ

00957	(C) 72mm (8044B)	5
00468	(C) 75mm (80140)	5
08750	(C) 75mm Οβάλ (82140)	5
02399	(C) 90mm (8094B)	5

HOT SELLER



09105



08051



14085

DOMUS



ΚΛΕΙΔΑΡΙΑ ΜΕΣΟΠΟΡΤΑΣ ΟΡΕΙΧΑΛΚΙΝΗ ECON LINE

09105	(C) 72mm (81245)	1
08051	(C) 75mm (81140)	1
14085	(C) 90mm (81940)	1



09376



13743

DOMUS



ΚΛΕΙΔΑΡΙΑ ΜΕΣΟΠΟΡΤΑΣ ΟΒΑΛ ΟΡΕΙΧΑΛΚΙΝΗ ECON LINE

09376	(C) 75mm (83140)	5
13743	(C) 90mm (83940)	5



DOMUS



ΚΛΕΙΔΑΡΙΑ ΜΕΣΟΠΟΡΤΑΣ ΧΡΩΜΙΟΥ

05776	(C) 75mm (80540)	5

GET IT NOW



00467
00492

DOMUS

ΚΛΕΙΔΑΡΙΑ ΜΕΣΟΠΟΡΤΑΣ ΧΩΡΙΣ ΦΙΝΙΡΙΣΜΑ

Κωδικός	Περιγραφή	Μονάδες
00467	(C) 75mm (80740)	5
00492	(C) 90mm (80940)	5



00466
11045

DOMUS

ΚΛΕΙΔΑΡΙΑ ΠΙΚΟΛΟ

Κωδικός	Περιγραφή	Μονάδες
00466	(C) 70mm (80640)	10
11045	Κλειδί (6 νούμερα)	10

GET IT NOW



DOMUS

ΑΝΤΙΚΡΥΣΜΑΤΑ TORGEAR 5 (ΣΕΤ 4 ΤΕΜΑΧΙΩΝ)

Κωδικός	Περιγραφή	Μονάδες
10534	CAMERA (94685)	5

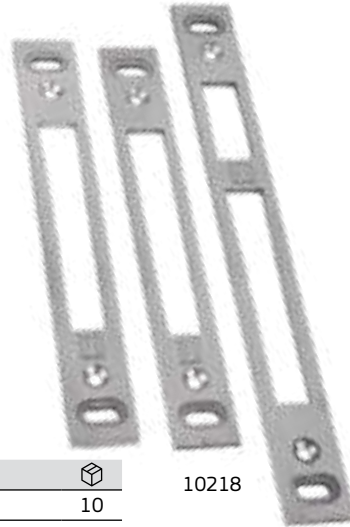

08293
10218
13821

DOMUS

ΑΝΤΙΚΡΥΣΜΑΤΑ ΡΥΘΜΙΖΟΜΕΝΑ ΓΙΑ ΚΛΕΙΔΑΡΙΑ 3 ΣΗΜΕΙΩΝ (ΣΕΤ 3 ΤΕΜΑΧΙΩΝ)

Κωδικός	Περιγραφή	Μονάδες
08293	Inox (93485X)	10
10218	CAMERA (93485)	10
13821	EUROPA (93483)	10

10218



08294
08308

DOMUS

ΑΝΤΙΚΡΥΣΜΑ ΡΥΘΜΙΖΟΜΕΝΟ ΓΙΑ ΓΛΩΣΣΟΥ & ΜΑΧΑΙΡΩΤΗ

Κωδικός	Περιγραφή	Μονάδες
08294	Inox (90185X)	10
08308	(90185)	10

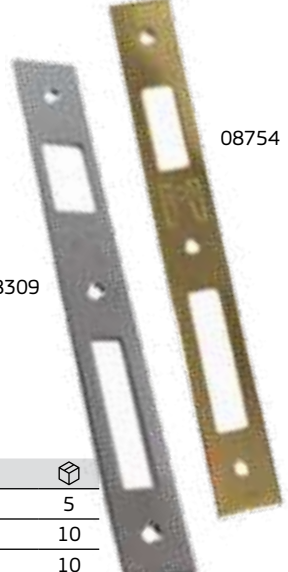

13008
08309
08754

DOMUS

ΑΝΤΙΚΡΥΣΜΑ

Κωδικός	Περιγραφή	Μονάδες
13008	Μεσόπορτας (80108)	5
08309	Γλωσσού (901800)	10
08754	Εξώπορτας (90808)	10

08309
08754

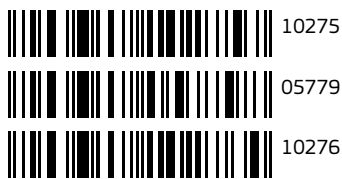

DOMUS



ΑΝΤΙΚΡΥΣΜΑ ΓΙΑ 901, 911, 914

Barcode	Product Name	Quantity
10275	ETEM (904810)	10
05779	ALUMIL & ALPIN (904820)	10
10276	EUROPA 500 (904830)	10



DOMUS

**HOT
SELLER**
**GET IT
NOW**

ΚΛΕΙΔΑΡΙΑ ΕΞΩΠΟΡΤΑΣ ΜΕ ΑΝΤΙΚΡΥΣΜΑ

Barcode	Product Name	Quantity
05443	Αριστερή (96250L)	5
05442	Δεξιά (96250R)	5



DOMUS

ΚΛΕΙΔΑΡΙΑ ΕΞΩΠΟΡΤΑΣ ΧΩΡΙΣ ΑΝΤΙΚΡΥΣΜΑ

Barcode	Product Name	Quantity
08158	Αριστερή (96050L)	5
08159	Δεξιά (96050R)	5



DOMUS



ΑΣΦΑΛΕΙΑ ΕΠΙΠΡΟΣΘΕΤΗ ΑΝΟΙΓΟΜΕΝΩΝ

Barcode	Product Name	Quantity
14078	Ασημί WK+(6470Z)	20
14079	Καφέ WK+(6470X)	20
11253	Λευκή WK+(6470L)	20
14455	Μαύρη WK+(6470M)	20



DOMUS



ΑΣΦΑΛΕΙΑ ΕΠΙΠΡΟΣΘΕΤΗ ΣΥΡΟΜΕΝΩΝ ΜΟΝΟΦΥΛΛΩΝ

Barcode	Product Name	Quantity
10121	Λευκή (6451L)	5



DOMUS



ΑΣΦΑΛΕΙΑ ΕΠΙΠΡΟΣΘΕΤΗ ΣΥΡΟΜΕΝΩΝ ΔΙΦΥΛΛΩΝ

Barcode	Product Name	Quantity
10211	Στενή Λευκή (6462L)	5

ΑΣΦΑΛΕΙΑ ΕΠΙΠΡΟΣΘΕΤΗ ΣΥΡΟΜΕΝΩΝ ΜΟΝΟΦΥΛΛΩΝ

Barcode	Product Name	Quantity
10210	Στενή Λευκή (6461L)	5



DOMUS



ΚΙΤ DSL SUPER INOX

Barcode	Product Name	Quantity
08477	7901X	5

 08476
 11479



ΚΛΕΙΔΑΡΙΑ DSL

Barcode	Color	Quantity
08476	Λευκή (7810L)	5
11479	Μαύρη (7810M)	5

 08790
 13948



ΚΛΕΙΔΑΡΙΑ DSL + KIT

Barcode	Color	Quantity
08790	Λευκή (7800L)	5
13948	Μαύρη (7800M)	5

 13412



ΚΛΕΙΔΑΡΙΑ DSL ΜΕ ΛΕΒΙΕ + KIT

Barcode	Color	Quantity
13412	Λευκή (7815L)	5

 14139
 14140
 14141
 14142



ΚΛΕΙΔΑΡΙΑ ΚΛΙΚΛΟΚ ΜΕ ΛΕΒΙΕ







Barcode	Color	Quantity
14139	Γκρι - Ασημί (7650Z)	5
14140	Καφέ (7650X)	5
14141	Λευκή (7650L)	5
14142	Μαύρη (7650M)	5

 06667
 06235
 03089
 13898



ΚΛΕΙΔΑΡΙΑ ΚΛΙΚΛΟΚ ΜΕ ΚΥΛΙΝΔΡΟ

Barcode	Color	Quantity
06667	Γκρι - Ασημί (7710Z)	5
06235	Καφέ (7710X)	5
03089	Λευκή (7710L)	5
13898	Μαύρη (7710M)	5

 05099
 00126
 03088
 06268



GET IT NOW

ΚΛΕΙΔΑΡΙΑ ΚΛΙΚΛΟΚ

Barcode	Color	Quantity
05099	Γκρι - Ασημί (7610Z)	5
00126	Καφέ (7610X)	5
03088	Λευκή (7610L)	5
06268	Μαύρη (7610M)	5



DOMUS



ΚΛΕΙΔΑΡΙΑ ΚΛΙΚΟΝ ΚΙΤ ΜΕ ΚΥΛΙΝΔΡΟ

04555	Λευκή (7720L)	5



DOMUS



ΚΛΕΙΔΑΡΙΑ ΚΛΙΚΟΝ ΚΙΤ

10046	Μαύρη (7620L)	5



10004



08660



05170



10641

DOMUS



ΚΥΛΙΝΔΡΟΣ ΑΛΦΑ ΝΙΚΕΛ

10004	65mm(30-35) (24065K)	5
08660	75mm(45-30) (24075K)	5
05170	83mm(53-30) (24083K)	5
10641	90mm(30-60) (24090K)	5



DOMUS



ΡΟΖΕΤΑ ΑΣΦΑΛΕΙΑΣ ΙΝΟΧ

10277	(20033N)	2



08156



12787



07685



13078



07686



06319

DOMUS



ΚΥΛΙΝΔΡΟΣ ΕCON ΝΙΚΕΛ

08156	65mm(30-35) (21065K)	10
07685	75mm(30-45) (21075K)	10
07686	83mm(30-53) (21083K)	10
06319	90mm(30-60) (21090K)	10
12787	100mm(45-55) (211100K)	10
13078	120mm(30-90) (210120K)	10

HOT SELLER

GET IT NOW



DOMUS



ΚΥΛΙΝΔΡΟΣ ΑΛΦΑ ΚΙΤΡΙΝΟΣ

05190	65mm (30-35) (24065)	5



DOMUS



ΚΥΛΙΝΔΡΟΣ ΕCON ΚΙΤΡΙΝΟΣ

06339	65mm(30-35) (21065)	10

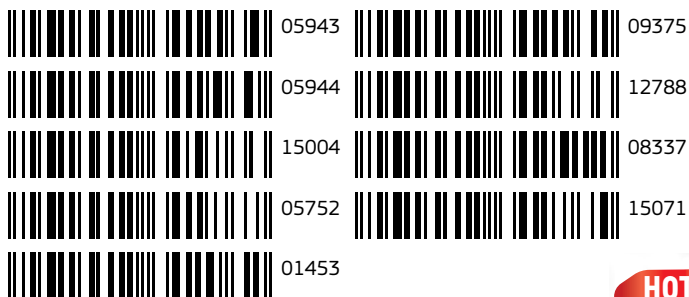

DOMUS



**HOT
SELLER**

**GET IT
NOW**

ΚΥΛΙΝΔΡΟΣ ΑΠΛΟΣ ΝΙΚΕΛ

Barcode	Product Code	Dimensions	Quantity
05943	54mm(27-27)	(11054K)	10
05944	60mm(30-30)	(16060K)	10
15004	70mm(35-35)	(16170K)	10
05752	75mm(30-45)	(16075K)	10
01453	83mm(30-53)	(16083K)	10
09375	90mm(30-60)	(16090K)	10
12788	95mm(45-50)	(16095K)	10
08337	100mm(30-70)	(160100K)	10
15071	100mm(35-65)	(161100K)	10



DOMUS



ΚΥΛΙΝΔΡΟΣ ΑΠΛΟΣ ΝΙΚΕΛ ΓΙΑ EUROPA 500

Barcode	Product Code	Dimensions	Quantity
08195	80mm(43,5-36,5)	(16080K)	5



DOMUS



ΚΥΛΙΝΔΡΟΣ ΟΒΑΛ ΝΙΚΕΛ

Barcode	Product Code	Dimensions	Quantity
00150	54mm(27-27)	(14054)	10



DOMUS



ΚΥΛΙΝΔΡΟΣ ΜΙΣΟΣ ΝΙΚΕΛ

Barcode	Product Code	Dimensions	Quantity
09926	40mm(30-10)	(16240K)	10



DOMUS



**HOT
SELLER**

**GET IT
NOW**

ΚΥΛΙΝΔΡΟΣ ΑΠΛΟΣ ΚΙΤΡΙΝΟΣ

Barcode	Product Code	Dimensions	Quantity
00558	54mm(27-27)	(11054)	10
00559	60mm(27-33)	(11060)	10
14013	60mm(30-30)	(16060)	10
03167	75mm(30-45)	(16075)	10
00400	83mm(30-53)	(16083)	10



DOMUS



ΚΥΛΙΝΔΡΟΣ EXPORT ΚΙΤΡΙΝΟΣ

Barcode	Product Code	Dimensions	Quantity
08595	65mm(30-35)	(16065)	5





08846
00598



ΚΛΕΙΔΙ PROTON

Barcode	Icon	Icon
08846	Συνδυασμού (25019)	1
00598	Άκοπο (25009)	1

06108
06566
05889
06567

ΚΛΕΙΔΙ ΑΠΛΟ ΚΙΤΡΙΝΟ

Barcode	Icon	Icon
06108	Κοντό (11009-L)	100
06566	Κοντό (11009-R)	100
05889	Μακρύ (16009-L)	100
06567	Μακρύ (16009-R)	100



00601



ΚΛΕΙΔΙ ALFA

Barcode	Icon	Icon
00601	Άκοπο (24009)	1

08781
08782
08783
08784

ΚΛΕΙΔΙ ΑΠΛΟ ΝΙΚΕΛ

Barcode	Icon	Icon
08781	Κοντό (11009-LN)	100
08782	Κοντό (11009-RN)	100
08783	Μακρύ (16009-LN)	100
08784	Μακρύ (16009-RN)	100

00602
14944



ΚΛΕΙΔΙ ECON

Barcode	Icon	Icon
00602	Άκοπο (21009)	1
14944	Συνδυασμού (21019)	1

08215



ΚΛΕΙΔΙ ΜΕΣΟΠΟΡΤΑΣ ΚΙΤΡΙΝΟ

Barcode	Icon	Icon
08215	No1-2-3-4-5-6 (80509B)	1





ΚΛΕΙΔΑΡΙΑ ΜΠΙΛΙΑΣ ΧΩΡΙΣ ΚΥΛΙΝΔΡΟ ΝΙΚΕΛ

Barcode	Icon	Icon
13181	(A) 20mm - code 06620	5





ΚΛΕΙΔΑΡΙΑ ΓΛΩΣΣΟΥ ΧΩΡΙΣ ΚΥΛΙΝΔΡΟ

Barcode	Icon	Icon
13175	(A) 20mm - code 06520	5
13176	(A) 25mm - code 06525	5
13179	(A) 30mm - code 06530	5
13180	(A) 35mm - code 06535	5





ΚΛΕΙΔΑΡΙΑ ΕΙΣΟΔΟΥ ΧΩΡΙΣ ΚΥΛΙΝΔΡΟ

Barcode	Icon	Icon
13182	(A) 45mm - Ορειχάλκινη (06645)	5
13183	(A) 45mm - Χρωμίου (06745)	5





ΚΛΕΙΔΑΡΙΑ ΠΙΚΟΛΟ

Barcode	Icon	Icon
13202	(C) 70mm - code 08070	5





ΚΛΕΙΔΑΡΙΑ ΕΞΩΠΟΡΤΑΣ ΜΕ ΑΝΤΙΚΡΥΣΜΑ

Barcode	Icon	Icon
13211	Αριστερή (08050)	2
13212	Δεξιά (08051)	2





ΚΥΠΡΙ ΗΛΕΚΤΡΙΚΟ ΙΝΟΧ

Barcode	Icon	Icon
10422	Απλό (08920)	5



ΚΛΕΙΔΑΡΙΕΣ

13207
13209

MARTIN
LOCK - PARALIA



ΚΛΕΙΔΑΡΙΑ ΜΕΣΟΠΟΡΤΑΣ ΤΥΠΟΥ ΙΤΑΛΙΑΣ ΟΡΕΙΧΑΛΚΙΝΗ

Barcode	Icon	Icon
13207	(C) 75mm - code 08475	5
13209	(C) 90mm - code 08490	5

13208
13210

MARTIN
LOCK - PARALIA



ΚΛΕΙΔΑΡΙΑ ΜΕΣΟΠΟΡΤΑΣ ΤΥΠΟΥ ΙΤΑΛΙΑΣ ΧΡΩΜΕ

Barcode	Icon	Icon
13208	(C) 75mm - code 08675	5
13210	(C) 90mm - code 08690	5

13204
13206

MARTIN
LOCK - PARALIA



ΚΛΕΙΔΑΡΙΑ ΜΕΣΟΠΟΡΤΑΣ ΤΥΠΟΥ ΙΤΑΛΙΑΣ ΟΒΑΛ ΧΡΩΜΕ

Barcode	Icon	Icon
13204	(C) 75mm - code 08775	5
13206	(C) 90mm - code 08790	5

MARTIN
LOCK - PARALIA



ΚΛΕΙΔΑΡΙΑ ΜΕΣΟΠΟΡΤΑΣ ΟΡΕΙΧΑΛΚΙΝΗ

Barcode	Icon	Icon
13200	(C) 75mm - code 08075	5

MARTIN
LOCK - PARALIA



ΚΛΕΙΔΑΡΙΑ ΜΕΣΟΠΟΡΤΑΣ ΧΡΩΜΕ

Barcode	Icon	Icon
13201	(C) 75mm - code 08275	5

■ NEW ARRIVAL ΝΕΑ ΑΦΙΞΗ ■ HOT SELLER ΚΑΛΥΤΕΡΟ ΣΤΗΝ ΠΩΛΗΣΗ ■ GET IT NOW ΑΞΙΖΕΙ ΝΑ ΑΓΟΡΑΣΕΙΣ ΤΩΡΑ

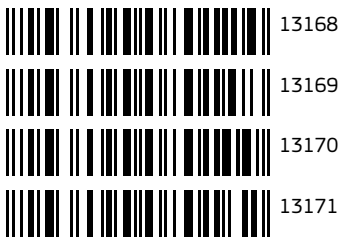

ΚΛΕΙΔΑΡΙΑ ΤΥΠΟΥ ΚΛΙΚΛΟΚ

Barcode	Icon	Box
13168	Ασημί - Γκρι (08012)	5
13169	Καφέ (08014)	5
13170	Λευκή (08010)	5
13171	Μαύρη (08016)	5

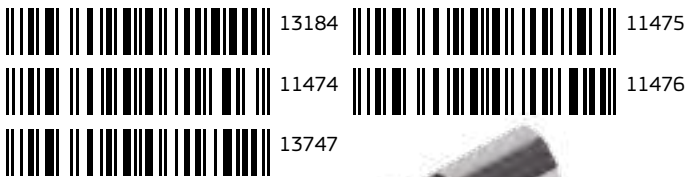

ΚΥΛΙΝΔΡΟΣ ΑΠΛΟΣ ΝΙΚΕΛ

Barcode	Icon	Box
13184	54mm(27-27) (07154)	10
11474	60mm(27-33) (07160)	10
13747	70mm(30-40) (07170)	10
11475	75mm(30-45) (07175)	10
11476	80mm(30-50) (07180)	10



ΚΥΛΙΝΔΡΟΣ ΑΠΛΟΣ ΚΙΤΡΙΝΟΣ

Barcode	Icon	Box
08948	54mm(27-27) (07054)	10
00561	60mm(27-33) (07060)	10
13746	70mm(30-40) (07070)	10
15034	80mm(30-50) (07080)	10



ΚΥΛΙΝΔΡΟΣ ΜΕ 5 ΚΛΕΙΔΙΑ ΝΙΚΕΛ

Barcode	Icon	Box
13185	60mm(27-33) (07360)	10
13186	70mm(30-40) (07370)	10
13187	75mm(30-45) (07375)	10
10392	80mm(30-50) (07380)	10
13188	85mm(30-55) (07385)	10
13189	90mm(40-50) (07390)	10
13190	90mm(30-60) (07391)	10
13191	100mm(35-65) (07310)	10



ΚΥΛΙΝΔΡΟΣ ΜΕ 5 ΚΛΕΙΔΙΑ ΑΝΤΙΒΡΕΑΚ ΝΙΚΕΛ

Barcode	Icon	Box
13192	60mm(27-33) (07560)	10
13193	70mm(30-40) (07570)	10
13194	75mm(30-45) (07575)	10
13195	80mm(30-50) (07580)	10
13196	80mm(35-45) (07581)	10
13197	90mm(40-50) (07590)	10
13198	90mm(30-60) (07591)	10
13199	100mm(35-65) (07510)	10



INTER

ΚΥΛΙΝΔΡΟΣ ΜΕ 5 ΚΛΕΙΔΙΑ ΝΙΚΕΛ

01373	70mm(30-40) (760065)	12

10423
 12358

abba

10423

ΚΛΕΙΔΑΡΙΑ ΓΛΩΣΣΟΥ ΑΒΒΑ

10423	(A) 20mm - κύλινδρος 54mm (30120)	5
12358	(A) 20mm - (30120T)	5

04615
 00474

INTER

ΚΛΕΙΔΑΡΙΑ ΣΙΔΗΡΟΠΟΡΤΑΣ

04615	Αριστερή (759926L)	2
00474	Δεξιά (759926R)	2

13529
 13530

abba

ΚΛΕΙΔΑΡΙΑ ΕΞΩΠΟΡΤΑΣ ΧΩΡΙΣ ΑΝΤΙΚΡΥΣΜΑ ΑΒΒΑ

13529	Αριστερή (36050L)	5
13530	Δεξιά (36050R)	5

00489
 00486

ΚΛΕΙΔΑΡΙΑ CONDOR

00489	15x8	2
00486	20x8	2

06366
 01745

INTER

ΚΛΕΙΔΑΡΙΑ ΕΞΩΠΟΡΤΑΣ ΜΕ ΑΝΤΙΚΡΥΣΜΑ

06366	Αριστερή (760040L)	5
01745	Δεξιά (760040R)	5

GET IT NOW





ΚΛΕΙΔΑΡΙΑ CONDOR

Barcode	Icon	Quantity
00487	20x8 No 9	2



00485



03448



04564



ΚΛΕΙΔΑΡΙΑ ΚΑΜΑΡΟΠΟΡΤΑΣ CONDOR

Barcode	Icon	Quantity
00485	Αριστερή	2
04564	Δεξιά	2
03448	Κλειδί Νο1-2-3-4-5-6	5



04656



00475



ΚΛΕΙΔΑΡΙΑ ΤΡΑΒΗΧΤΗ CONDOR

Barcode	Icon	Quantity
04656	Αριστερή	2
00475	Δεξιά	2



00491



04822



ΚΛΕΙΔΑΡΙΑ ΤΖΑΜΟΠΟΡΤΑΣ CONDOR

Barcode	Icon	Quantity
00491	Αριστερή	2
04822	Δεξιά	2



10311



10312





ΚΛΕΙΔΑΡΙΑ ΣΙΔΗΡΟΠΟΡΤΑΣ 310 CONDOR

Barcode	Icon	Quantity
10311	Αριστερή	2
10312	Δεξιά	2



06054





00470



06055



02574

ΚΛΕΙΔΑΡΙΑ ΣΥΡΤΑΡΙΩΝ

Barcode	Icon	Quantity
06054	20mm	12
00470	25mm	12
06055	30mm	12
02574	Κλειδί Νο1-2-3-4	10

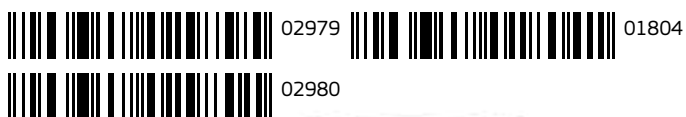

02979

01804



02980

**ΧΟΥΦΤΑ ΝΙΚΕΛ**

Barcode	Image	Box
02979	4"	12
02980	5"	12
01804	6"	12



08864



08865

**ΠΕΙΡΟΣ ΑΣΦΑΛΕΙΑΣ**

Barcode	Image	Box
08864	No 100	50
08865	No 200	50



02356

03895



00690

00693

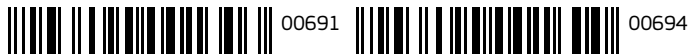

00691

00694



03894

00974



00692

00974

ΛΟΥΚΕΤΟ ΚΙΤΡΙΝΟ ΒΑΡΕΩΣ ΤΥΠΟΥ

Barcode	Image	Box
02356	20mm - code 00120	12
00690	25mm - code 00125	12
00691	30mm - code 00130	12
03894	35mm - code 00135	12
00692	40mm - code 00140	12
03895	45mm - code 00145	12
00693	50mm - code 00150	6
00694	60mm - code 00160	6
00974	75mm - code 00175	6



12334



10203



10204



10205



00689

MORETTI**ΛΟΥΚΕΤΟ ΚΙΤΡΙΝΟ ΣΙΔΕΡΕΝΙΟ**

Barcode	Image	Box
12334	25mm - code 00702	12
10203	32mm - code 00704	12
10204	38mm - code 00706	12
10205	50mm - code 00708	6
00689	63mm - code 00710	6



06448



06449



06450

ΛΟΥΚΕΤΟ ΚΙΤΡΙΝΟ ΠΑΣΠΑΡΤΟΥ ΒΑΡΕΩΣ ΤΥΠΟΥ

Barcode	Image	Box
06448	40mm - code 00040	12
06449	50mm - code 00050	6
06450	60mm - code 00060	6



13228



13097



13098



13099



13100



13101

MORETTI**ΛΟΥΚΕΤΟ ΜΑΚΡΥΛΑΙΜΟ ΚΙΤΡΙΝΟ ΣΙΔΕΡΕΝΙΟ**

Barcode	Image	Box
13228	20mm - code 00718	12
13097	22mm - code 00720	12
13098	32mm - code 00722	6
13099	38mm - code 00724	6
13100	50mm - code 00726	6
13101	63mm - code 00728	6



	00444
	03295
	00698
	00129
	07033



ΛΟΥΚΕΤΟ ΚΙΤΡΙΝΟ ΜΑΚΡΥΛΑΙΜΟ

00444	25mm - code 00225	12
03295	30mm - code 00230	12
00698	40mm - code 00240	12
00129	50mm - code 00250	6
07033	60mm - code 00260	6



	00677		00681
	00678		00683
	00679		00684
	00680		



ΛΟΥΚΕΤΟ ΚΙΤΡΙΝΟ ΕΛΑΦΡΟΥ ΤΥΠΟΥ

00677	20mm - 00320	12
00678	25mm - 00325	12
00679	30mm - 00330	12
00680	35mm - 00335	12
00681	40mm - 00340	12
00683	50mm - 00350	6
00684	60mm - 00360	6



	12045		12047
	12046		12048

MORETTI



ΛΟΥΚΕΤΟ ΤΑΚΟΣ ΚΙΤΡΙΝΟ

12045	60mm - code 00750	6
12046	70mm - code 00752	6
12047	80mm - code 00754	6
12048	90mm - code 00756	6

	10026		08535
	10027		

INTER



ΛΟΥΚΕΤΟ ΤΑΚΟΣ ΣΙΔΕΡΕΝΙΟ

10026	74mm	6
10027	84mm	6
08535	94mm	6

--	--



ΓΩΝΙΑ ΛΟΥΚΕΤΟΥ

03183	Ζεύγος	2

--	--

INTER



ΛΟΥΚΕΤΟ ΜΗΧΑΝΩΝ (ΦΙΔΙ)

03504	22mm x 150cm	2

 09318
 09319
 09319

ΚΛΕΙΔΟΘΗΚΗ

Barcode	Περιγραφή	Μονάδα
09318	20 θέσεων - 200x160x80mm	1
09319	45 θέσεων - 300x240x80mm	1





ΣΟΥΣΤΕΣ ΚΛΕΙΔΙΩΝ ΤΥΠΟΥ ΔΑΓΚΑΝΑΣ

Barcode	Περιγραφή	Μονάδα
08978	No6 (6717)	100

 01753
 06397
 10660
 10660

ΚΑΡΤΕΛΟΘΗΚΗ ΚΛΕΙΔΙΩΝ

Barcode	Περιγραφή	Μονάδα
01753	Σετ 12 τμχ. Κίνα	12
10660	Κουτί 100 τμχ. Γερμανία	1
06397	Κουτί 200 τμχ. Ταϊβάν	1

 00554
 01157
 01383
 09316
 01384



ΣΟΥΣΤΑ ΚΛΕΙΔΙΩΝ

Barcode	Περιγραφή	Μονάδα
00554	55mm - code 5211	100
01383	60mm - code 6613	100
01384	80mm - code 8116	100
01157	90mm - code 9018	50
09316	103mm - code 10529	50



ΚΑΡΤΕΛΟΘΗΚΗ ΔΑΚΤΥΛΙΟΥ ΤΑΪΒΑΝ

Barcode	Περιγραφή	Μονάδα
06398	Κουτί 200 τμχ.	1

 08971
 08973
 08972



ΣΟΥΣΤΑ ΚΛΕΙΔΙΩΝ ΠΑΛΑΙΟΥ ΤΥΠΟΥ

Barcode	Περιγραφή	Μονάδα
08971	No4	25
08972	No5	25
08973	No6	50





**ΠΟΜΟΛΟ ΕΞΩΠΟΡΤΑΣ
ΣΕΙΡΑ 200 85**

		
06383	Αριστερό Νίκελ Ματ	2





**ΠΟΜΟΛΟ ΜΕΣΟΠΟΡΤΑΣ
ΧΩΡΙΣ ΡΟΖΕΤΑ 110**

		
01070	Ασημί	15





**ΠΟΜΟΛΟ ΣΙΔΗΡΟΠΟΡΤΑΣ
FIX (ΜΙΣΟ) 110/25F**

		
05921	Ασημί	10





**ΠΟΜΟΛΟ ΣΙΔΗΡΟΠΟΡΤΑΣ
110/20**

		
01073	Ασημί	20
01072	Λευκό	20





ΠΟΜΟΛΟ ΜΕΣΟΠΟΡΤΑΣ

		
06194	Ασημί - code 08929	12
06195	Λευκό - code 08930	12





ΠΟΜΟΛΟ ΜΕΣΟΠΟΡΤΑΣ 110/40

		
00788	Ασημί	14
01076	Καφέ	14
01074	Λευκό	14



ΠΟΜΟΛΑ

12765
12764

12765

ΠΟΜΟΛΟ ΣΙΔΗΡΟΠΟΡΤΑΣ ΜΑΚΡΥ ΣΙΔΕΡΟ 110/20

12765	Ασημί με Άλλεν	20
12764	Ασημί με καρφί	20

01071

ΠΟΜΟΛΟ ΣΙΔΗΡΟΠΟΡΤΑΣ 120/20

01071	Καφέ	14
-------	------	----

06197
06198

ΠΟΜΟΛΟ ΣΙΔΗΡΟΠΟΡΤΑΣ

06197	Ασημί - code 08933	12
06198	Λευκό - code 08932	12

08506
10108
08505

ΛΑΒΗ 150

08506	Ασημί	60
10108	Καφέ	60
08505	Λευκή	60

10419
10464
10420
15053

ΠΟΜΟΛΟ ΣΙΔΗΡΟΠΟΡΤΑΣ 160/10

10419	Ασημί	16
10464	Λευκό	16
10420	Μαύρο	16
15053	Καφέ	16

00308
02328
04016
00309
00676

ΓΡΥΛΟΧΕΡΟ 110

00308	Ασημί / 7	25
02328	Καφέ / 7	25
04016	Λευκό / 7	25
00309	Ασημί / 8	25
00676	Λευκό / 8	25

NEW ARRIVAL ΝΕΑ ΑΦΙΞΗ ■ HOT SELLER ΚΑΛΥΤΕΡΟ ΣΤΗΝ ΠΩΛΗΣΗ ■ GET IT NOW ΑΞΙΖΕΙ ΝΑ ΑΓΟΡΑΣΕΙΣ ΤΩΡΑ





ΓΡΥΛΟΠΟΜΟΛΟ ΤΥΠΟΥ ΟΞΑΛ

		
07705	Ασημί	20





ΓΡΥΛΟΣ ΕΞΩΤΕΡΙΚΟΣ

		
00297	(97/98)	10





ΓΡΥΛΟΣ ΧΩΝΕΥΤΟΣ

		
02264	Ορειχάλκινος - code 7400B	10





ΓΡΥΛΟΣ ΧΩΝΕΥΤΟΣ

		
00298	Χωρίς φινιρίσμα	10







01947
00191
01296

01947

ΒΕΡΓΑ ΧΩΝΕΥΤΟΥ ΓΡΥΛΟΥ

		
01947	1,40m	50
00191	2,20m	50

ΒΕΡΓΑ ΕΞΩΤΕΡΙΚΟΥ ΓΡΥΛΟΥ

		
01296	1,40m	50





01805
07569

ΧΕΡΟΥΛΙΑ ΦΕΓΓΙΤΩΝ

		
01805	Αριστερό	24
07569	Δεξί	24

	02114		00147		03434
	01883		00153		03435
	01630		01215		03436
	00072		01216		03437
	02018		00051		03439

**ΑΛΥΣΙΔΑ ΓΑΛΒΑΝΙΖΕ ΣΕ ΚΑΡΟΥΛΙ**

02114	Φ2,5mm	20kg
01883	Φ3,0mm	20kg
01630	Φ3,5mm	20kg
00072	Φ4,0mm	20kg
02018	Φ4,5mm	20kg
00147	Φ5,0mm	20kg
00153	Φ6,0mm	20kg
01215	Φ7,0mm	20kg
01216	Φ8,0mm	20kg
00051	Φ10mm	20kg

ΑΛΥΣΙΔΑ ΣΕ ΚΑΡΟΥΛΙ ΘΕΡΜΟ ΓΑΛΒΑΝΙΣΜΑ

03434	Φ4,0mm	20kg
03435	Φ5,0mm	20kg
03436	Φ6,0mm	20kg
03437	Φ8,0mm	20kg
03439	Φ10mm	20kg



07740

07741

**ΑΛΥΣΙΔΑ ΔΙΑΚΟΣΜΗΤΙΚΗ 10m**

07740	Νίκελ	1
07741	Κίτρινη	1

00053

00054

ΑΛΥΣΙΔΑ ΠΛΑΣΤΙΚΗ 25m ΚΟΚΚΙΝΗ / ΑΣΠΡΗ

00053	Φ6mm Ιταλίας	1
00054	Φ8mm Κίνας	1

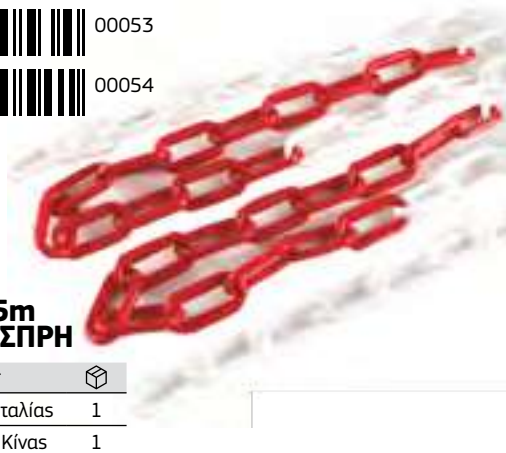

12766

12365

12767

**ΡΟΔΑΝΤΖΑ ΙΝΟΧ**

12766	Φ5mm	50
12365	Φ6mm	20
12767	Φ8mm	10
12768	Φ10mm	10
12769	Φ12mm	10

ΣΥΡΜΑΤΟΣΧΟΙΝΟ - ΣΦΙΓΚΤΗΡΑΣ - ΝΑΥΤΙΚΑ ΚΛΕΙΔΙΑ

	15594		08390
	15595		08391
	15596		08392
	15597		08394



ΣΥΡΜΑΤΟΣΧΟΙΝΟ ΓΑΛΒΑΝΙΖΕ

15594	Φ2mm - 6x12 Κ.Ψ.	10
15595	Φ2mm - 6x12 Κ.Ψ.	25
15596	Φ3mm - 6x12 Κ.Ψ.	10
15597	Φ3mm - 6x12 Κ.Ψ.	25
08390	Φ3mm - 6x12 Κ.Ψ.	100
08391	Φ4mm - 6x12 Κ.Ψ.	100
08392	Φ5mm - 6x12 Κ.Ψ.	100
08394	Φ6mm - 6x12 Κ.Ψ.	100

	14289		13338
	12198		13272



NEW
ARRIVAL

ΣΥΡΜΑΤΟΣΧΟΙΝΟ INOX

14289	Φ2mm - 7x19 Κ.Ψ.	250
12198	Φ4mm - 7x19 Κ.Ψ.	250
13338	Φ5mm - 7x19 Κ.Ψ.	250
13272	Φ6mm - 7x19 Κ.Ψ.	100

	01389		01393
	01390		01394
	01391		01396
	01392		01397



ΣΦΙΓΚΤΗΡΑΣ ΣΥΡΜΑΤΟΣΧΟΙΝΟΥ ΓΑΛΒΑΝΙΖΕ

01389	Φ3mm	200
01390	Φ5mm	100
01391	Φ6mm	100
01392	Φ8mm	50



ΣΦΙΓΚΤΗΡΑΣ ΣΥΡΜΑΤΟΣΧΟΙΝΟΥ INOX

12637	Φ4mm	50
12199	Φ5mm	50
12359	Φ6mm	20
13271	Φ8mm	10

	09989		09990
--	-------	--	-------



ΝΑΥΤΙΚΟ ΚΛΕΙΔΙ «Ω» INOX

09989	12	5
09990	16	1

	08974		08976
	08975		08977



ΑΓΚΙΣΤΡΟ ΓΑΛΒΑΝΙΖΕ ΜΕ ΒΙΔΑ

08974	5	100	08976	8	50
08975	6	100	08977	10	25



ΝΑΥΤΙΚΟ ΚΛΕΙΔΙ ΓΑΛΒΑΝΙΖΕ

Barcode	Icon	Quantity
00917	Φ5mm	100
00918	Φ6mm	100
00919	Φ8mm	50
00920	Φ10mm	50
02306	Φ11mm	20
00921	Φ12mm	25



Barcode	Icon	Quantity
02239	Φ14mm	20
00922	Φ16mm	10
00923	Φ20mm	5
00924	Φ22mm	5
00925	Φ25mm	5

ΝΑΥΤΙΚΟ ΚΛΕΙΔΙ INOX

Barcode	Icon	Quantity
11006	Φ5mm	50
11007	Φ6mm	20
09986	Φ7mm	20
11008	Φ8mm	10
11009	Φ10mm	10
09987	Φ12mm	5
14782	Φ13mm	10
09988	Φ16mm	5



ΑΓΚΙΣΤΡΟ ΑΥΤΟΜΑΤΟ ΓΑΛΒΑΝΙΖΕ

Barcode	Icon	Quantity
03163	Φ4x40mm	200
00010	Φ5x50mm	150
00155	Φ6x60mm	100
00156	Φ8x80mm	50
00157	Φ10x100mm	25
00158	Φ12x140mm	10

ΑΓΚΙΣΤΡΟ ΑΥΤΟΜΑΤΟ INOX

Barcode	Icon	Quantity
11010	Φ5x50mm	20
09991	Φ6x60mm	20
09992	Φ7x70mm	20
09993	Φ8x80mm	20
11011	Φ10x100mm	10
11012	Φ11x120mm	10

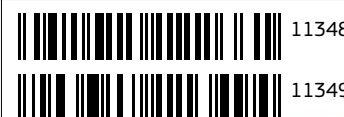

ΑΓΚΙΣΤΡΟ ΑΥΤΟΜΑΤΟ INOX ΜΕ ΒΙΔΑ

Barcode	Icon	Quantity
11348	Φ6x60mm (Φ x μήκος)	20
11349	Φ8x80mm (Φ x μήκος)	20
11350	Φ10x100mm (Φ x μήκος)	10



ΑΓΚΙΣΤΡΟ ΑΥΤΟΜΑΤΟ ΑΛΟΥΜΙΝΙΟΥ

Barcode	Icon	Quantity
03356	Φ5x50mm (Φ x μήκος) - code 94320	125
02373	Φ6x60mm (Φ x μήκος) - code 94322	125
00584	Φ8x80mm (Φ x μήκος) - code 94324	30

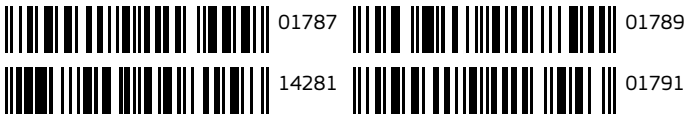

01787

01789



14281



01791



ΧΑΛΚΑΣ ΑΚΟΛΛΗΤΟΣ ΝΙΚΕΛ

Barcode	Code	Quantity
	No20	100
	No22	100
	No30	100
	No40	100



14372

14375



14373



14376



14374



14377



ΧΑΛΚΑΣ ΚΟΛΛΗΤΟΣ ΓΑΛΒΑΝΙΖΕ

Barcode	Code	Quantity
	No22	200
	No25	250
	No30	250
	No35	250
	No40	250
	No50	200



01690



11357

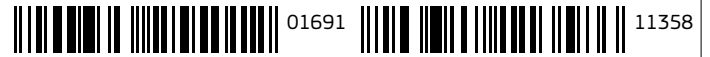

01691



11358



01692



11359

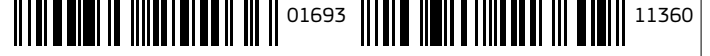

01693



11360



01694



11361



01695



01696



ΕΝΤΑΤΗΡΑΣ ΓΑΛΒΑΝΙΖΕ

Barcode	Code	Quantity
	5mm	25
	6mm	25
	8mm	20
	10mm	15
	12mm	10
	16mm	5
	20mm	5

ΕΝΤΑΤΗΡΑΣ ΙΝΟΧ

Barcode	Code	Quantity
	5mm	10
	6mm	20
	8mm	10
	10mm	5
	12mm	5



02579



02259



01427



03497



01428



ΣΥΝΔΕΤΙΚΟ

Barcode	Code	Quantity
	Ø3mm	200
	Ø4mm	200
	Ø5mm	100
	Ø6mm	100
	Ø8mm	100



ΠΑΛΑΓΚΟ ΚΡΙΚΟΥ

01093	2 Τόνων	2
-------	---------	---



ΚΑΡΚΙΝΟΣ ΣΥΡΜΑΤΟΣΧΟΙΝΩΝ

02539	Ø1-5mm	1
-------	--------	---



ΓΑΝΤΖΟΣ ΒΑΡΕΩΣ ΤΥΠΟΥ ΓΑΛΒΑΝΙΖΕ

00055	500 Κιλών	5
00056	750 Κιλών	5



ΓΑΝΤΖΟΣ ΒΑΡΕΩΣ ΤΥΠΟΥ ΓΑΛΒΑΝΙΖΕ ΠΕΡΙΣΤΡΕΦΟΜΕΝΟΣ

00023	1 Τόνου	5
00024	2 Τόνων	5



ΚΛΕΙΔΙ ΓΙΑ ΠΕΡΙΦΡΑΞΕΙΣ

05880	No100 - 90gr MARTIN	100
14032	No100 - 110gr INTER	100
14033	No120 - 180gr INTER	100



ΠΑΛΑΓΚΟ ΑΛΥΣΙΔΑΣ

04519	0,5T x 3m	1
04520	1T x 3m	1
04573	1T x 5m	1
04521	2T x 5m	1



00915

00563



00916



ΜΑΚΑΡΑΣ ΔΙΠΛΟΣ

Barcode	Size	Quantity
00915	2"	3
00916	3"	3
00563	4"	3

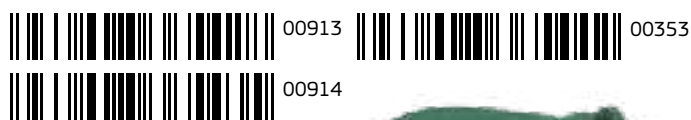

00913

00353



00914



ΜΑΚΑΡΑΣ ΜΟΝΟΣ

Barcode	Size	Quantity
00913	2"	3
00914	3"	3
00353	4"	3



07963

07964

Martin
H. G. Martin



ΜΑΚΑΡΑΣ ΚΛΕΙΣΤΟΥ ΤΥΠΟΥ

Barcode	Size	Quantity
07963	25mm Μονός	50
07964	38mm Διπλός	25



06824

06703

06440

01015



06824

06440

ΒΙΤΖΙ ΤΑΪΒΑΝ

Barcode	Capacity	Quantity
06824	1000Lb με συρματόσχοινο	1
06440	1200Lb χωρίς συρματόσχοινο	1
06703	1400Lb χωρίς συρματόσχοινο	1
01015	2000Lb χωρίς συρματόσχοινο	1



ΡΥΜΟΥΛΚΑ ΤΑΪΒΑΝ ΜΕ 2 ΓΑΝΤΖΟΥΣ

Barcode	Capacity	Quantity
00373	Εως 500kg	5



ΜΠΙΛΙΑ ΤΡΕΪΛΕΡ

Barcode	Size	Quantity
02903	2"x 3/4"	6



ΦΩΛΙΑ ΤΡΕΪΛΕΡ



06550



2½ x 2"



2



ΙΜΑΝΤΑΣ ΠΡΟΣΔΕΣΗΣ ΜΕ ΠΟΡΠΗ



10555



3m x 25mm



5



01992



09353



ΙΜΑΝΤΑΣ ΑΥΤΟΚΙΝΗΤΩΝ



01992



1' x 15Ft (5m)



5

09353

2' x 15Ft (5m)

6



ΙΜΑΝΤΑΣ ΦΟΡΤΗΓΟΥ



02785



2» x 27Ft (9m)



1



INTER



**ΚΟΡΔΟΝΙ ΕΛΑΣΤΙΚΟ
2 ΓΑΝΤΖΩΝ Φ12mm**



06021



120cm x12mm Μαύρο



6



ΧΤΑΠΟΔΙΑ



01801



4 τμχ. (36") - 8 γάντζοι



10

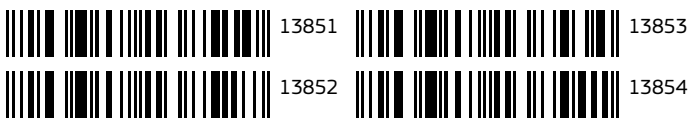

ΣΧΟΙΝΙ ΕΛΑΣΤΙΚΟ 100m

Barcode	Icon	Weight
13851	No6 Μπλε	kg
13852	No8 Μπλε	kg
13853	No8 Πορτοκαλί	kg
13854	No10 Πορτοκαλί	kg



ΙΜΑΝΤΑΣ ΑΝΥΨΩΣΗΣ

Barcode	Icon	Weight
10553	1,2T 4m x 50mm	1
10554	1,2T 5m x 50mm	1
14785	1,2T 6m x 50mm	1
04365	2T 3m x 60mm	1
07061	2T 4m x 60mm	1
04366	2T 5m x 60mm	1
04367	3T 3m x 90mm	1
04368	3T 5m x 90mm	1
04572	3T 6m x 90mm	1



NEW
ARRIVAL

ΓΑΝΤΖΟΣ ΜΕΤΑΛΛΙΚΟΣ ΓΙΑ ΕΛΑΣΤΙΚΟ ΣΧΟΙΝΙ

Barcode	Icon	Weight
14592	Φ8mm	50



GET IT
NOW

HOT
SELLER

ΣΧΟΙΝΙ ΠΛΕΚΤΟ

Barcode	Icon	Weight
08132	Φ3mm	kg
01020	Φ3,5mm	kg
00617	Φ4mm	kg
03019	Φ5mm	kg
03750	Φ6mm	kg
03751	Φ8mm	kg
03752	Φ10mm	kg
03753	Φ12mm	kg
03754	Φ14mm	kg
00399	Φ16mm	kg
05795	Φ18mm	kg
05796	Φ20mm	kg



ΣΠΑΓΓΟΙ

05173
02143



**ΣΠΑΓΓΟΣ ΠΛΑΣΤΙΚΟΣ
ΣΥΣΚΕΥΑΣΙΑΣ**

Barcode	Weight	Quantity
05173	1/2 Kg	12
02143	1 Kg	12

02284
05519



ΣΠΑΓΓΟΣ ΣΙΖΑΛ

Barcode	Weight	Quantity
02284	1/2 Κιλό	12
05519	1 Κιλό	15



**ΣΧΟΙΝΙ ΜΠΕΖ
ΠΟΛΥΠΡΟΠΥΛΕΝΙΟΥ**

Barcode	Weight	Quantity
01834	Φ3,5mm	kg

01589
07859



ΣΠΑΓΓΟΣ ΚΕΡΙΝΟΣ

Barcode	Weight	Quantity
01589	Ψιλός	1kg
07859	Χοντρός	1kg

GET IT NOW
HOT SELLER

05463 07274
07271 00063
07386 01869
07273



ΣΧΟΙΝΙ ΣΙΖΑΛ

Barcode	Weight	Quantity
05463	Φ5mm	kg
07271	Φ6mm	kg
07386	Φ8mm	kg
07273	Φ10mm	kg

07274
00063
01869



ΣΧΟΙΝΙ ΣΙΖΑΛ

Barcode	Weight	Quantity
07274	Φ12mm	kg
00063	Φ14mm	kg
01869	Φ16mm	kg

■ NEW ARRIVAL ΝΕΑ ΑΦΙΞΗ ■ HOT SELLER ΚΑΛΥΤΕΡΟ ΣΤΗΝ ΠΩΛΗΣΗ ■ GET IT NOW ΑΞΙΖΕΙ ΝΑ ΑΓΟΡΑΣΕΙΣ ΤΩΡΑ

ΠΑΜΑΤΑ





**ΠΑΜΑ ΒΑΜΒΑΚΕΡΟ
ΓΙΑ ΚΡΕΟΠΩΛΗ**

		
04364	500gr	Kg



03940



01194



ΠΑΜΑ ΠΛΑΣΤΙΚΟ

		
03940	Διπλό (100gr)	kg
01194	Μονό (70gr)	kg



02850



01195



02850



01195

ΠΑΜΑ ΒΑΜΒΑΚΕΡΟ

		
02850	Χοντρό (100gr)	kg
01195	Ψιλό (100gr)	kg



06369



04652



ΠΑΜΑ ΠΛΑΣΤΙΚΟ

		
06369	100gr	4



ΝΗΜΑ ΑΛΙΕΙΑΣ ΚΙΤΡΙΝΟ

		
04652	No12 (100gr)	5



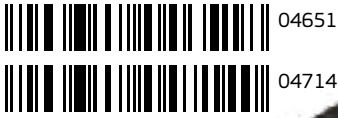

ΠΕΤΟΝΙΑ 100m

Barcode	Icon	Quantity
04651	No80	10
04714	No100	10

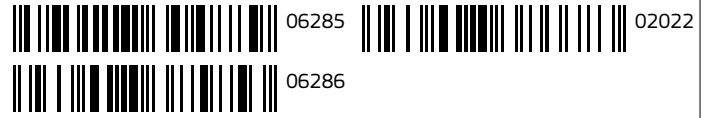

ΣΑΚΟΡΑΦΑ ΝΙΚΕΛ

Barcode	Icon	Quantity
06285	4"	25
06286	5"	25
02022	6"	25

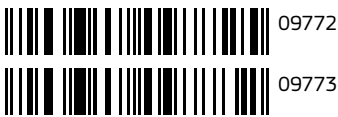

ΣΥΡΜΑ ΓΙΑ ΣΑΚΟΥΛΕΣ ΜΠΑΖΩΝ

Barcode	Icon	Quantity
09772	1mm x 10cm	3000
09773	1mm x 12cm	3000









ΣΑΚΟΡΑΦΑ ΜΕ ΣΠΑΓΓΟ & ΣΥΡΜΑ

Barcode	Icon	Quantity
05811	Σετ	50



ΣΤΡΙΦΤΗΡΙ ΣΥΡΜΑΤΩΝ

Barcode	Icon	Quantity
10658	Γερμανίας	1

 05018
 02863
 03898



ΒΑΣΗ ΔΙΑΙΡΟΥΜΕΝΗ







Barcode	Material	Quantity
05018	Γαλβανισέ	20
02863	Μαύρη	20
03898	Inox	20

 05788



ΒΑΣΗ ΔΙΑΙΡΟΥΜΕΝΗ ΒΑΡΕΩΣ ΤΥΠΟΥ

Barcode	Material	Quantity
05788	Μαύρη	10

 06971
 12385
 11209



ΒΑΣΗ ΔΑΠΕΔΟΥ ΜΑΥΡΗ









Barcode	Material	Quantity
06971	No7	22
12385	No8	22
11209	No10	22

 03248
 04248
 02085
 04966
 04836











ΒΑΣΗ ΣΤΑΘΕΡΗ ΠΑΡΑΔΟΣΙΑΚΗ ΜΑΥΡΗ

Barcode	Material	Quantity
03248	No7	20
04248	No8	20
02085	No9	20
04966	No10	20
04836	No12	20

 05716
 05715
 05660
 01757

 04027
 04028
 04967
 07038

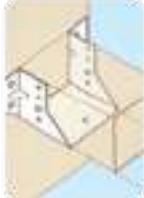
ΔΟΚΟΘΗΚΗ INOX

Barcode	Material	Quantity
05716	No5	60
05715	No7	60
05660	No8	60

 01757
 04027
 04028
 04967
 07038

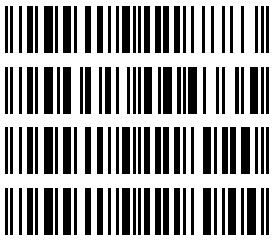

ΔΟΚΟΘΗΚΗ ΓΑΛΒΑΝΙΖΕ

Barcode	Material	Quantity
01757	No5	70
04027	No6	60
04028	No7	60
04967	No8	60
07038	No9	60

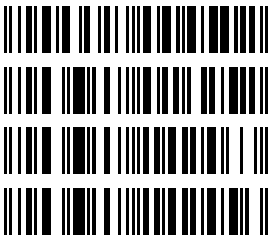

03572



07040

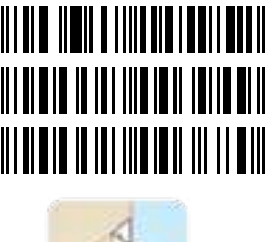

14595

12486

07041



ΔΟΚΟΘΗΚΗ ΜΑΥΡΗ

03572	No5	70
05764	No6	60
04833	No7	60
01254	No8	60
07040	No9	60

ΔΟΚΟΘΗΚΗ ΓΑΛΒΑΝΙΖΕ ΒΑΡΕΩΣ ΤΥΠΟΥ

14595	No10	40



ΔΟΚΟΘΗΚΗ ΚΙΤΡΙΝΗ

01625	No6	60
14246	No7	60
14245	No8	60



ΔΟΚΟΘΗΚΗ ΜΑΥΡΗ ΒΑΡΕΩΣ ΤΥΠΟΥ

12486	No9	40
07041	No10	40

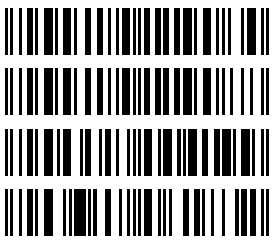

05783

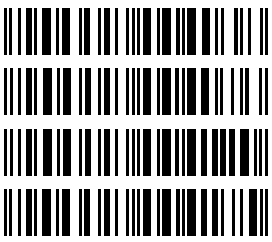

04802

04205

04204

04526



ΔΟΚΟΘΗΚΗ ΜΕ ΚΛΙΣΗ 22% ΜΑΥΡΗ

05783	No6	60
00077	No7	60
05469	No8	60
06183	No8	60



ΔΟΚΟΘΗΚΗ ΜΕ ΚΛΙΣΗ 22% ΓΑΛΒΑΝΙΖΕ

04802	No5	70
04205	No6	60
04204	No7	60
04526	No8	60

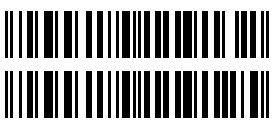

03478

09370

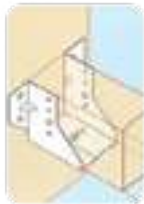

ΔΟΚΟΘΗΚΗ ΔΙΑΙΡΟΥΜΕΝΗ

03478	Γαλβανιζέ	60
09370	Μαύρη	60



08007 06335
04288 04951
05089

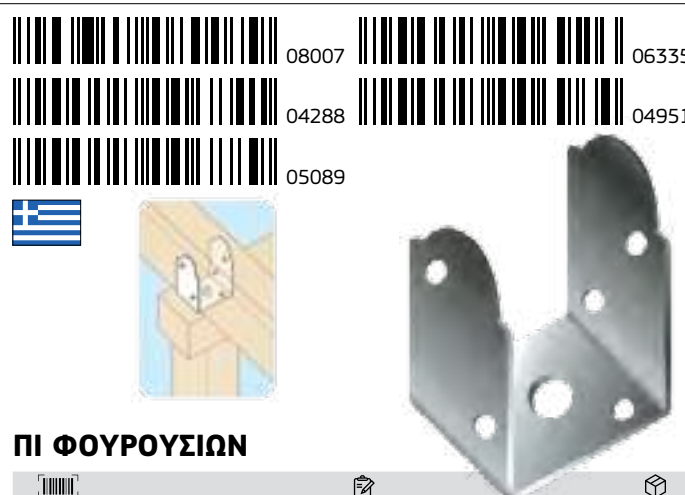

ΠΙ ΦΟΥΡΟΥΣΙΩΝ

Barcode	Product Name	Quantity
08007	No5 Άβαβο	100
04288	No5 Γαλβανιζέ	100
05089	No6 Γαλβανιζέ	100
06335	No7 Γαλβανιζέ	100
04951	No8 Γαλβανιζέ	100

06069 05956
05941 05957
05942



ΤΑΠΕΣ ΚΟΙΛΟΔΟΚΟΥ ΜΕΤΑΛΛΙΚΕΣ

Barcode	Product Name	Quantity
06069	40x40mm	500
05941	50x50mm	400
05942	60x60mm	250
05956	80x80mm	200
05957	100x100mm	150

04306



ΛΑΜΑΚΙ ΣΥΝΔΕΣΗΣ ΣΤΕΓΗΣ

Barcode	Product Name	Quantity
04306	1000x80x2mm	20

02176
00152
05879

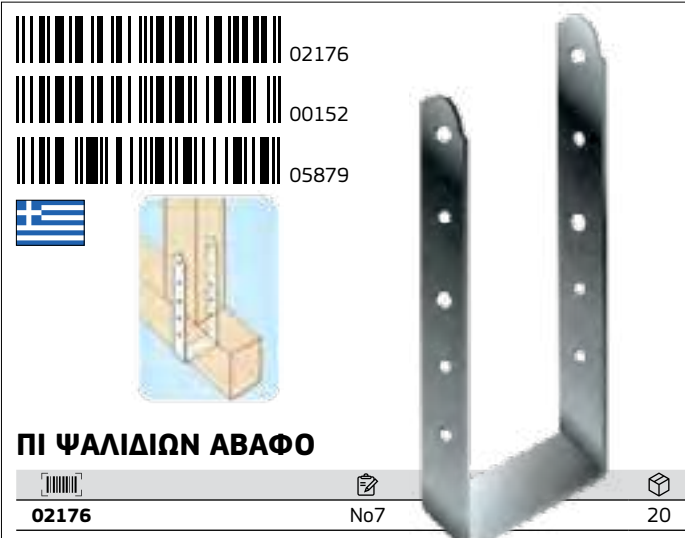

ΠΙ ΨΑΛΙΔΙΩΝ ΑΒΑΦΟ

Barcode	Product Name	Quantity
02176	No7	20
00152	No8	20
05879	No10	20

04703
04527
04704
04528



ΛΑΜΑΚΙ ΣΥΝΔΕΣΗΣ ΣΤΕΓΗΣ ΓΑΛΒΑΝΙΖΕ

Barcode	Product Name	Quantity
04703	100x40x2mm	400
04527	120x40x2mm	400
04704	160x40x2mm	200
04528	180x40x2mm	200

05954
01922
03934



ΩΜΕΓΑ ΨΑΛΙΔΙΩΝ ΓΑΛΒΑΝΙΖΕ

Barcode	Product Name	Quantity
05954	No7 - 165mm	40
01922	No8 - 160mm	40
03934	No9 - 155mm	40



01641
04037







**ΛΑΜΑΚΙ ΣΥΝΔΕΣΗΣ ΣΤΕΓΗΣ Νο1
160X60X2mm**

01641	Γαλβανιζέ	200
04037	Μαύρο	200

02312
03567





**ΛΑΜΑΚΙ ΣΥΝΔΕΣΗΣ ΣΤΕΓΗΣ Νο2
255X70X2mm**

02312	Γαλβανιζέ	100
03567	Μαύρο	100

04332





**ΛΑΜΑΚΙ ΣΥΝΔΕΣΗΣ ΣΤΕΓΗΣ ΜΑΥΡΟ Νο3
490x100x2mm**

04332	490x100x2mm	30

01222







ΤΑΦ ΓΩΝΙΑ ΜΙΚΡΗ

01222	Μαύρη	70



00932

ΤΑΦ ΜΕΓΑΛΟ

00932	Μαύρο	50

03355

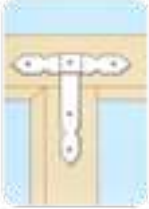
ΤΑΦ ΜΙΚΡΟ

03355	Μαύρο	70





ΓΩΝΙΑ ΤΕΛΑΡΩΜΑΤΟΣ

03354	Μαύρη	60





ΣΤΗΡΙΓΜΑ ΚΟΥΠΑΣΤΗΣ

03938	Μαύρο	100
03937	Χρυσό	100





ΣΤΗΡΙΓΜΑ ΦΟΥΡΟΥΣΙΩΝ ΜΑΥΡΟ

04556	Μαύρο	25
04557	Μεσαίο	20





ΣΤΕΓΑΚΙ ΠΑΡΑΘΥΡΩΝ ΒΑΡΕΩΣ ΤΥΠΟΥ

03807	Μαύρο	3
05643	Μεγάλο	2









ΓΩΝΙΑ 40x40x50

10047	Γαλαβανιζέ	400
03946	Μαύρη	400

ΓΩΝΙΑ 60x60x40

05081	Γαλαβανιζέ	300
07351	Μαύρη	300





ΓΩΝΙΑ 80x80x40

07352	Μαύρη	250

ΓΩΝΙΑ 90x90x40

01055	Μαύρη	200



ΠΕΡΓΚΟΛΑ

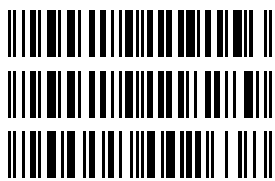

04927

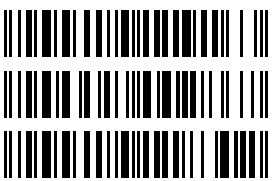

04495

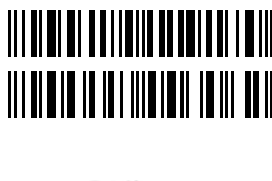

04529

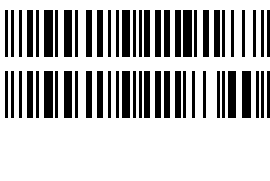

01821



ΓΩΝΙΑ 50x50x40

Barcode	Material	Quantity
04927	Γαλβανιζέ	500
03449	Μαύρη	500
10515	Inox	50



ΓΩΝΙΑ 70x70x53

Barcode	Material	Quantity
04495	Γαλβανιζέ	200
05661	Inox	50
01380	Μαύρη	200



ΓΩΝΙΑ 90x90x65

Barcode	Material	Quantity
04529	Γαλβανιζέ	100
03469	Μαύρη	100



ΓΩΝΙΑ 100x100x80

Barcode	Material	Quantity
01821	Γαλβανιζέ	80
03877	Μαύρη	80



03484



03115



02624



08960



ΓΩΝΙΑ 60x100x60

Barcode	Material	Quantity
03484	Γαλβανιζέ	200
03878	Μαύρη	200



ΓΩΝΙΑ 130x130x70

Barcode	Material	Quantity
03115	Γαλβανιζέ	80
04255	Μαύρη	80



ΓΩΝΙΑ 130x130x80 ΒΑΡΕΩΣ ΤΥΠΟΥ

Barcode	Material	Quantity
02624	Μαύρη	60



ΓΩΝΙΑ 200x200x80

Barcode	Material	Quantity
08960	Μαύρη	30



01533



00016



13350



ΓΩΝΙΑ 135°

Barcode	Material	Quantity
01533	Μαύρη 130x130x70	100



ΓΩΝΙΑ 170x80x65

Barcode	Material	Quantity
00016	Μαύρη	50



ΓΩΝΙΑ 250x100x80

Barcode	Material	Quantity
13350	Μαύρη	30

■ NEW ARRIVAL ΝΕΑ ΑΦΙΞΗ ■ HOT SELLER ΚΑΛΥΤΕΡΟ ΣΤΗΝ ΠΩΛΗΣΗ ■ GET IT NOW ΑΞΙΖΕΙ ΝΑ ΑΓΟΡΑΣΕΙΣ ΤΩΡΑ



03344



03919

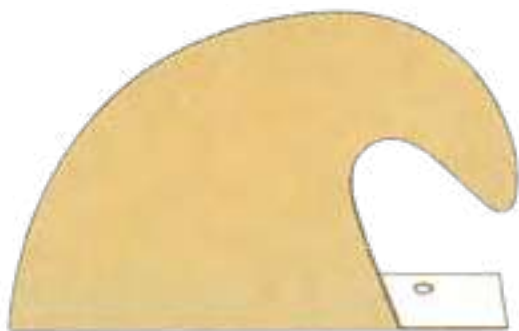

ΚΑΛΥΠΤΡΑ ΓΩΝΙΑΚΗ ΜΕΤΑΛΛΙΚΗ

Barcode	Color	Quantity
03344	Κόκκινη	1000
03919	Μπεζ	1000



01495



03899

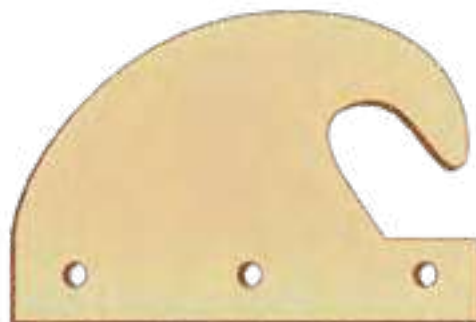

ΚΑΛΥΠΤΡΑ ΙΣΙΑ ΜΕΤΑΛΛΙΚΗ

Barcode	Color	Quantity
01495	Κόκκινη	1000
03899	Μπεζ	1000



ΚΑΛΥΠΤΡΑ ΠΛΑΣΤΙΚΗ

Barcode	Color	Quantity
04296	Μπεζ	600



02978



08837



ΚΕΡΑΜΙΔΟΚΟΦΤΗΣ

Barcode	Color	Quantity
02978	Ενισχυμένος	1
08837	Ανταλλακτική μύτη	1

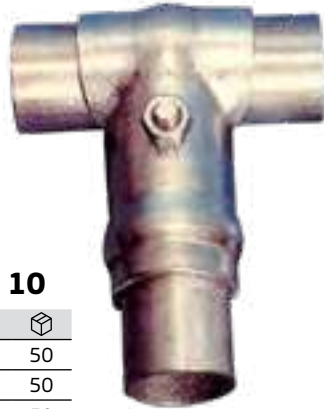
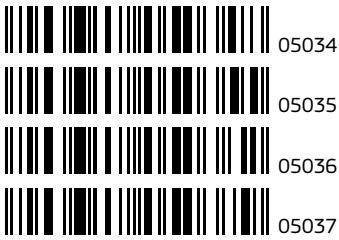

ΣΩΛΗΝΟΣΥΝΔΕΣΗ ΣΕΙΡΑ 10

Barcode	Icon	Quantity
05034	Φ33mm - 1"	50
05035	Φ42mm - 1¼"	50
05036	Φ48mm - 1½"	50
05037	Φ60mm - 2"	50

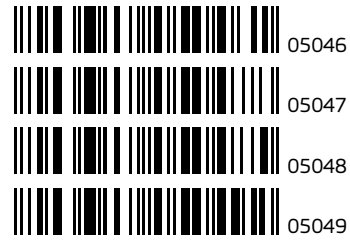

ΣΩΛΗΝΟΣΥΝΔΕΣΗ ΣΕΙΡΑ 40

Barcode	Icon	Quantity
05046	Φ33mm - 1"	50
05047	Φ42mm - 1¼"	50
05048	Φ48mm - 1½"	50
05049	Φ60mm - 2"	50

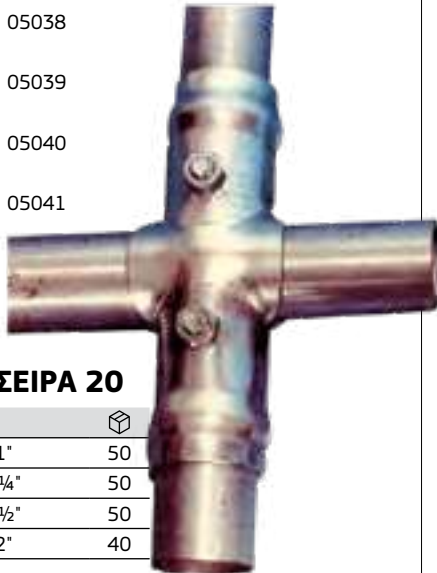

ΣΩΛΗΝΟΣΥΝΔΕΣΗ ΣΕΙΡΑ 20

Barcode	Icon	Quantity
05038	Φ33mm - 1"	50
05039	Φ42mm - 1¼"	50
05040	Φ48mm - 1½"	50
05041	Φ60mm - 2"	40



ΣΩΛΗΝΟΣΥΝΔΕΣΗ ΣΕΙΡΑ 50

Barcode	Icon	Quantity
05050	Φ33mm - 1"	50
05051	Φ42mm - 1¼"	50
05052	Φ48mm - 1½"	40

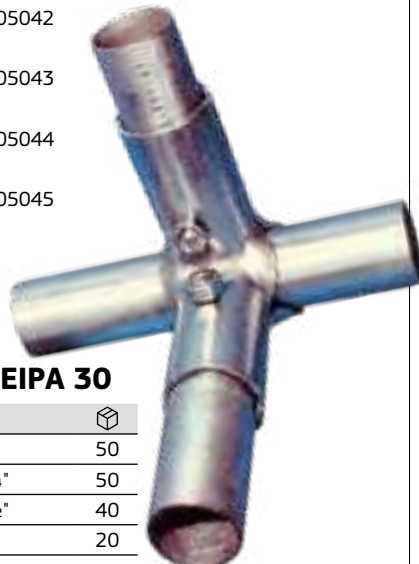

ΣΩΛΗΝΟΣΥΝΔΕΣΗ ΣΕΙΡΑ 30

Barcode	Icon	Quantity
05042	Φ33mm - 1"	50
05043	Φ42mm - 1¼"	50
05044	Φ48mm - 1½"	40
05045	Φ60mm - 2"	20

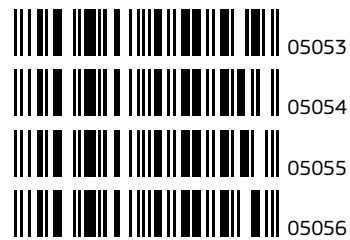

ΣΩΛΗΝΟΣΥΝΔΕΣΗ ΣΕΙΡΑ 60

Barcode	Icon	Quantity
05053	Φ33mm - 1"	50
05054	Φ42mm - 1¼"	50
05055	Φ48mm - 1½"	50
05056	Φ60mm - 2"	50



05057



05058



05059



05060



ΣΩΛΗΝΟΣΥΝΔΕΣΗ ΣΕΙΡΑ 70

05057	Φ33mm - 1"	50
05058	Φ42mm - 1¼"	50
05059	Φ48mm - 1½"	50
05060	Φ60mm - 2"	50



00085



05062



05063



05064



ΣΩΛΗΝΟΣΥΝΔΕΣΗ ΣΕΙΡΑ 80

00085	Φ33mm - 1"	50
05062	Φ42mm - 1¼"	50
05063	Φ48mm - 1½"	50
05064	Φ60mm - 2"	50



05065



05066



05067



05068



ΣΩΛΗΝΟΣΥΝΔΕΣΗ ΣΕΙΡΑ 90

05065	Φ33mm - 1"	50
05066	Φ42mm - 1¼"	50
05067	Φ48mm - 1½"	50
05068	Φ60mm - 2"	50



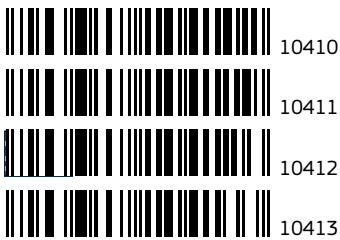

ΣΩΛΗΝΟΣΥΝΔΕΣΗ ΣΕΙΡΑ 100

Barcode	Icon	Icon
10410	Φ33mm - 1"	50
10411	Φ42mm - 1¼"	50
10412	Φ48mm - 1½"	50
10413	Φ60mm - 2"	50



ΣΩΛΗΝΟΣΥΝΕΣΗ ΣΕΙΡΑ 120

Barcode	Icon	Icon
07403	Φ33mm - 1"	30
07404	Φ42mm - 1¼"	30
07405	Φ48mm - 1½"	30
07406	Φ60mm - 2"	30



ΣΩΛΗΝΟΣΥΝΕΣΗ ΣΕΙΡΑ 110

Barcode	Icon	Icon
10414	Φ33mm - 1"	30
10415	Φ42mm - 1¼"	30
10416	Φ48mm - 1½"	30
10417	Φ60mm - 2"	30

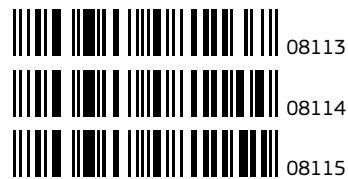

ΣΩΛΗΝΟΣΥΝΔΕΣΗ ΣΕΙΡΑ 140

Barcode	Icon	Icon
08113	Φ33mm - 1"	50
08114	Φ42mm - 1¼"	50
08115	Φ48mm - 1½"	50



00453
00646



ΣΙΤΑ ΑΛΟΥΜΙΝΙΟΥ

Barcode	Dimensions	Roll
00453	1,0 x 25m (πλάτος x μήκος)	Ρολό
00646	1,2 x 25m (πλάτος x μήκος)	Ρολό



01437
01438



ΣΙΤΑ ΓΑΛΒΑΝΙΖΕ

Barcode	Dimensions	Roll
01437	1,0 x 25m (πλάτος x μήκος)	Ρολό
01438	1,2 x 25m (πλάτος x μήκος)	Ρολό



05360
05361



ΣΙΤΑ ΙΝΟΧ

Barcode	Dimensions	Roll
05360	1,0 x 25m (πλάτος x μήκος)	Ρολό
05361	1,2 x 25m (πλάτος x μήκος)	Ρολό



06795 05232
05230 05421
05231



ΣΙΤΑ ΑΜΕΡΙΚΑΝΙΚΟΥ ΤΥΠΟΥ FIBERGLASS

Barcode	Dimensions	Roll
06795	0,8 x 25m (πλάτος x μήκος)	Ρολό
05230	1,0 x 25m (πλάτος x μήκος)	Ρολό
05231	1,2 x 25m (πλάτος x μήκος)	Ρολό
05232	1,5 x 25m (πλάτος x μήκος)	Ρολό
05421	1,8 x 25m (πλάτος x μήκος)	Ρολό

GET IT NOW
HOT SELLER



02186 02121
02232 02354
02233 02336
02563



ΣΥΡΜΑ ΕΞΑΓΩΝΟ 1/2" 25m

Barcode	Dimensions	Roll
02186	0,8m (πλάτος)	Ρολό
02232	1,0m (πλάτος)	Ρολό
02233	1,2m (πλάτος)	Ρολό
02563	1,5m (πλάτος)	Ρολό

ΣΥΡΜΑ ΕΞΑΓΩΝΟ 1" 25m

Barcode	Dimensions	Roll
02121	1,0m (πλάτος)	Ρολό
02354	1,2m (πλάτος)	Ρολό
02336	1,5m (πλάτος)	Ρολό



ΣΥΡΜΑ ΚΑΡΕ

Barcode	Code	Quantity
05890	2.5 (Ανοιγμα 1cm)	30m
01374	3 (Ανοιγμα 8mm)	30m
01375	4 (Ανοιγμα 6mm)	30m
01376	6 (Ανοιγμα 4mm)	30m
06712	7 (Ανοιγμα 3.5mm)	30m
01377	8 (Ανοιγμα 3mm)	30m
01378	10 (Ανοιγμα 2.5mm)	30m

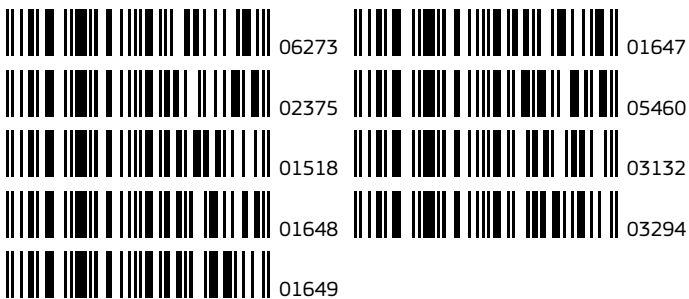

ΠΛΕΓΜΑ ΚΟΛΛΗΤΟ 1/2"x1"

Barcode	Code	Quantity
06273	0,4 x 25m (πλάτος x μήκος)	Ρολό
02375	0,5 x 25m (πλάτος x μήκος)	Ρολό
01518	0,6 x 25m (πλάτος x μήκος)	Ρολό
01648	0,8 x 25m (πλάτος x μήκος)	Ρολό
01649	1,0 x 25m (πλάτος x μήκος)	Ρολό
01647	1,2 x 25m (πλάτος x μήκος)	Ρολό
05460	1,5 x 25m (πλάτος x μήκος)	Ρολό

ΠΛΕΓΜΑ ΚΟΛΛΗΤΟ 1"x1"

Barcode	Code	Quantity
03132	1,0 x 25m (πλάτος x μήκος)	Ρολό
03294	1,2 x 25m (πλάτος x μήκος)	Ρολό



GET IT NOW

HOT SELLER

ΣΥΡΜΑ ΚΑΡΟΥΛΑΚΙ ΓΑΛΒΑΝΙΖΕ

Barcode	Code	Quantity
06693	Φ1,0mm x 27m	30
13313	Φ1,3mm x 20m	30
13314	Φ1,5mm x 15m	30
13315	Φ2,0mm x 9m	30



ΣΥΡΜΑ ΚΑΡΟΥΛΑΚΙ ΟΡΕΙΧΑΛΚΙΝΟ

Barcode	Code	Quantity
13320	Φ0,6mm x 20m	20
13321	Φ0,8mm x 12m	20
13322	Φ1,0mm x 7m	20



ΣΥΡΜΑ ΚΑΡΟΥΛΑΚΙ ΙΝΟΧ

Barcode	Code	Quantity
13319	Φ0,6mm x 20m	20
13323	Φ0,8mm x 12m	20
13324	Φ1,0mm x 7m	20



ΣΥΡΜΑ ΚΑΡΟΥΛΑΚΙ ΧΑΛΚΙΝΟ

Barcode	Code	Quantity
13316	Φ0,6mm x 20m	20
13317	Φ0,8mm x 12m	20
13318	Φ1,0mm x 7m	20

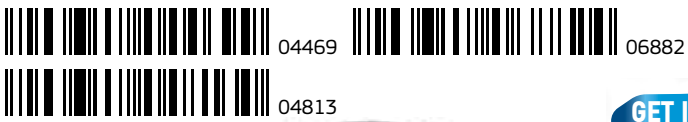

04469

06882



04813



GET IT NOW

ΣΥΡΜΑ ΜΑΥΡΟ

Barcode	Icon	Weight
04469		7 (1,2mm) 20kg
04813		12 (1,8mm) 20kg
06882		16 (2,7mm) 20kg

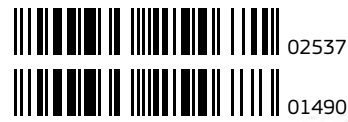

02537

01490



GET IT NOW

ΣΥΡΜΑ ΓΙΑ ΑΠΛΩΜΑ ΡΟΥΧΩΝ

Barcode	Icon	Weight
02537		25m (2-3mm) 5
01490		25m (2-4mm) 5



01358

02303

01359

01363

01360

01364

01361

01366

01362

06111



HOT SELLER

ΣΥΡΜΑ ΓΑΛΒΑΝΙΖΕ

Barcode	Icon	Weight
01358		4 (0,9mm) 20kg
01359		5 (1,0mm) 20kg
01360		6 (1,1mm) 20kg
01361		7 (1,2mm) 20kg
01362		8 (1,3mm) 20kg
02303		10 (1,6mm) 20kg
01363		12 (1,8mm) 20kg
01364		14 (2,2mm) 20kg
01366		16 (2,7mm) 20kg
06111		18 (3,4mm) 20kg

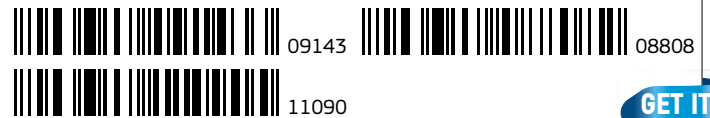

09143

08808

11090



GET IT NOW

ΥΦΑΣΜΑ ΕΔΑΦΟΚΑΛΥΨΗΣ ΜΑΥΡΟ

Barcode	Icon	Weight
09143		1m 100m
11090		2m 100m
08808		3m 100m





ΑΠΟΣΤΡΑΓΓΙΣΤΙΚΗ ΜΕΜΒΡΑΝΗ

07367	2x20m (400gr/m ²)	m ²



05415



04924



01875



ΔΙΧΤΥ ΣΟΒΑΤΙΣΜΑΤΟΣ FIBERGLASS 50m

05415	25cm (πλάτος)	200m
04924	50cm (πλάτος)	100m
01875	100cm (πλάτος)	50m



ΔΙΧΤΥ ΥΠΟΓΕΙΩΝ ΝΕΡΟΥ

13946	30cm (πλάτος)	250m



ΔΙΧΤΥ ΥΠΟΓΕΙΩΝ ΚΑΛΩΔΙΩΝ ΟΤΕ

05431	30cm (πλάτος)	250m

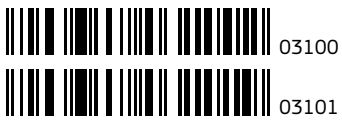

03100

03101

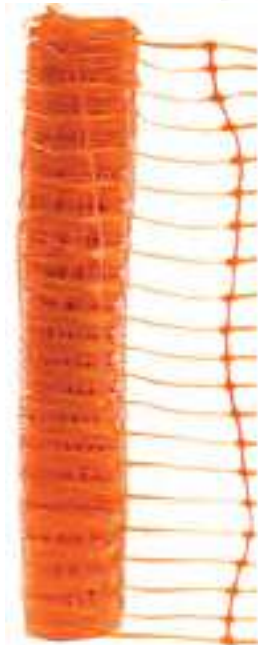

GET IT
NOW

ΔΙΧΤΥ ΟΔΟΣΗΜΑΝΣΗΣ ΠΟΡΤΟΚΑΛΙ

Barcode	Icon	Icon
03100	1,0m (πλάτος)	50m
03101	1,2m (πλάτος)	50m



ΔΙΧΤΥ ΑΝΤΙΑΝΕΜΙΚΟ

Barcode	Icon	Icon
12613	1 x 50m (πλάτος x μήκος)	m ²

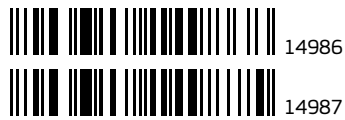

14986

14987



ΔΙΧΤΥ ΣΚΙΑΣΗΣ ΓΚΡΙ Ε125 (90%)

Barcode	Icon	Icon
14986	2 x 50m (πλάτος x μήκος)	m ²
14987	4 x 50m (πλάτος x μήκος)	m ²

NEW
ARRIVAL

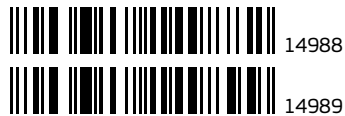

14988

14989



ΔΙΧΤΥ ΣΚΙΑΣΗΣ ΜΠΕΖ Ε125 (90%)

Barcode	Icon	Icon
14988	2 x 50m (πλάτος x μήκος)	m ²
14989	4 x 50m (πλάτος x μήκος)	m ²

NEW
ARRIVAL



08757

10513

HOT
SELLER



08757

10513



ΚΛΙΠΣ ΓΙΑ ΔΙΧΤΥ ΣΚΙΑΣΗΣ

Barcode	Icon	Icon
08757	2 σημείων	200
10513	Πλακάκι	100

	04838		06545		12726		08759
	07028		07166		12727		08779
	07268		08799		08758		08780
	08774		08777		06593		08760
	08775		07002		07169		08761
	12737		08778		07928		



ΔΙΧΤΥ ΣΚΙΑΣΗΣ ΠΡΑΣΙΝΟ E30 (30%)

04838	2 x 100m (πλάτος x μήκος)	m ²
07028	3 x 100m (πλάτος x μήκος)	m ²
07268	4 x 100m (πλάτος x μήκος)	m ²
08774	5 x 100m (πλάτος x μήκος)	m ²
08775	6 x 100m (πλάτος x μήκος)	m ²
12737	8 x 100m (πλάτος x μήκος)	m ²

E60 (45%)

06545	2 x 100m (πλάτος x μήκος)	m ²
07166	3 x 100m (πλάτος x μήκος)	m ²
08799	4 x 100m (πλάτος x μήκος)	m ²

E90 (60%)

08777	2 x 50m (πλάτος x μήκος)	m ²
07002	3 x 50m (πλάτος x μήκος)	m ²
08778	4 x 50m (πλάτος x μήκος)	m ²



GET IT
NOW



E125 (90%)

12726	1 x 50m (πλάτος x μήκος)	m ²
12727	1,5 x 50m (πλάτος x μήκος)	m ²
08758	2 x 50m (πλάτος x μήκος)	m ²
06593	3 x 50m (πλάτος x μήκος)	m ²
07169	4 x 50m (πλάτος x μήκος)	m ²
07928	5 x 50m (πλάτος x μήκος)	m ²
08759	6 x 50m (πλάτος x μήκος)	m ²

E190 (90-95%)

08779	2 x 50m (πλάτος x μήκος)	m ²
08780	3 x 50m (πλάτος x μήκος)	m ²
08760	4 x 50m (πλάτος x μήκος)	m ²
08761	5 x 50m (πλάτος x μήκος)	m ²

	08843		09065		08763
	08264		08849		00014
	08762		09063		09064
	05662		08265		08764



ΔΙΧΤΥ ΜΠΑΛΚΟΝΙΟΥ ΠΛΑΣΤΙΚΟ 1m

08843	Γκρι	50m
08264	Καφέ	50m
08762	Λευκό	50m
05662	Μαύρο	50m
09065	Μπλε	50m
08849	Πράσινο	50m

ΔΙΧΤΥ ΜΠΑΛΚΟΝΙΟΥ ΠΛΑΣΤΙΚΟ 1,2m

09063	Γκρι	50m
08265	Καφέ	50m
08763	Λευκό	50m
00014	Μαύρο	50m
09064	Μπλε	50m
08764	Πράσινο	50m

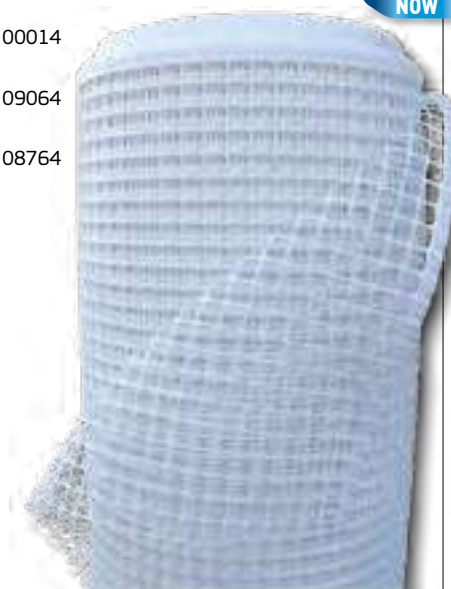

GET IT
NOW



ΣΚΕΠΑΣΤΡΟ ΠΟΛΥΑΙΘΥΛΕΝΙΟΥ 90gr

Barcode	Code	Dimensions	Quantity
	04661	2 x 3m (πλάτος x μήκος)	5
	04663	3 x 5m (πλάτος x μήκος)	5
	04664	4 x 5m (πλάτος x μήκος)	5
	04665	5 x 8m (πλάτος x μήκος)	5
	04666	6 x 10m (πλάτος x μήκος)	3
	07085	6 x 12m (πλάτος x μήκος)	3
	04667	8 x 12m (πλάτος x μήκος)	2



GET IT NOW

ΣΚΕΠΑΣΤΡΟ ΠΟΛΥΑΙΘΥΛΕΝΙΟΥ 115gr

Barcode	Code	Dimensions	Quantity
	13356	2 x 3m (πλάτος x μήκος)	5
	13357	3 x 5m (πλάτος x μήκος)	6
	13358	4 x 5m (πλάτος x μήκος)	4
	13359	5 x 8m (πλάτος x μήκος)	4
	13360	6 x 10m (πλάτος x μήκος)	3
	13361	6 x 12m (πλάτος x μήκος)	2
	13362	8 x 12m (πλάτος x μήκος)	1

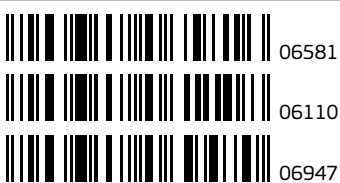

ΛΙΝΑΤΣΑ ΟΞΙΟΥΤΗΣ

Barcode	Code	Dimensions	Quantity
	06581	1,0m (πλάτος)	50m
	06110	1,35m (πλάτος)	50m
	06947	1,80m (πλάτος)	50m

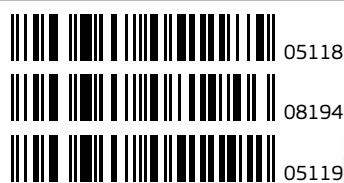

ΛΙΝΑΤΣΑ ΛΕΥΚΗ ΥΦΑΝΤΗ

Barcode	Code	Dimensions	Quantity
	05118	1,0 x 100m (πλάτος x μήκος)	kg
	08194	1,5 x 100m (πλάτος x μήκος)	kg
	05119	2,0 x 100m (πλάτος x μήκος)	kg

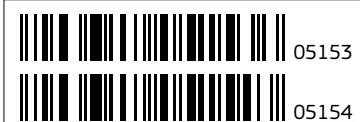

ΛΙΝΑΤΣΑ ΓΚΡΙ ΥΦΑΝΤΗ

Barcode	Code	Dimensions	Quantity
	05153	3 x 100m (πλάτος x μήκος)	kg
	05154	4 x 100m (πλάτος x μήκος)	kg

09497

09498

NEW ARRIVAL

ΝΑΥΛΟΝ ΒΑΨΙΜΑΤΟΣ ΜΕ ΧΑΡΤΟΤΑΙΝΙΑ

09497	16m x 2700mm - code 41000/7	12
09498	20m x 550mm - code 41000/13	8

09358

80m

m²

ΑΕΡΟΧΑΡΤ 1m

06605

07402

HOT SELLER

ΧΑΡΤΙ ΟΝΤΟΥΛΕ 1m

06605	12kg	kg
07402	26kg	kg

03173

00981

09305

GET IT NOW
HOT SELLER

ΝΑΥΛΟΝ ΒΑΨΙΜΑΤΟΣ 4x5m

03173	Ψιλό - 5mic (60gr)	40
00981	Μεσαίο - 18mic (250gr)	25
09305	Χονδρό - 40mic (640gr)	25

09700

Ανακυκλωμένο

kg

ΧΑΡΤΙ DUPLEX 1m

09356

09357

GET IT NOW

ΑΕΡΟΠΛΑΣΤ 1m

09356	10m	20
09357	50m	3



09038



09418



09419



ΑΤΣΑΛΟΜΑΛΛΟ ΣΕ ΡΟΛΛΟ

Barcode	Icon	Volume
09038	No0 Ψιλό (1Kg)	5
09418	No1 Μεσαίο (2Kg)	5
09419	No2 Χονδρό (2Kg)	5



09039



09040



12203



GET IT NOW

ΑΤΣΑΛΟΜΑΛΛΟ ΣΑΚΟΥΛΑΚΙ 100gr

Barcode	Icon	Volume
09039	No1 Μεσαίο	30
09040	No2 Χονδρό	30
12203	No3 Χονδρό	30



12018



12019

INTER

ΑΤΣΑΛΟΜΑΛΛΟ ΣΑΚΟΥΛΑΚΙ 110gr

Barcode	Icon	Volume
12018	No1 Μεσαίο	12
12019	No2 Χονδρό	12



12520



12519



ΣΚΟΥΠΑΚΙ ΧΟΡΤΟΥ ΜΙΚΡΟ

Barcode	Icon	Volume
12520	Τζακιού	10

ΣΚΟΥΠΑ ΧΟΡΤΟΥ ΜΕ ΚΟΝΤΑΡΙ

Barcode	Icon	Volume
12519	Μάγισσας	10



GET IT NOW



07039



08062



04174



ΚΟΝΤΑΡΙ ΣΚΟΥΠΑΣ

Barcode	Icon	Volume
07039	1,30m Με σπείρωμα	24

ΞΥΛΟ ΣΚΟΥΠΑΣ

Barcode	Icon	Volume
08062	1,20m Με σπείρωμα	25

ΞΥΛΟ ΣΚΟΥΠΑΣ

Barcode	Icon	Volume
04174	1,20m Χωρίς σπείρωμα	10

03694
02081

INTER

05259



ΦΑΡΑΣΙ ΜΕΤΑΛΛΙΚΟ ΜΕ ΞΥΛΙΝΗ ΛΑΒΗ

03694 223 x 233mm 6



GET IT NOW

HOT SELLER



ΦΑΡΑΣΙ ΣΚΟΥΠΙΔΙΩΝ ΓΑΛΒΑΝΙΖΕ

02081 223 x 233mm 12



ΦΑΡΑΣΙ ΟΡΘΟΣΤΑΤΙΚΟ

05259 Γαλβανιζέ 5

06660



ΣΚΟΥΠΑ 101

06660 310 x 75mm (BxA) 12



05930



ΣΚΟΥΠΑ 111

05930 280 x 30mm (BxA) 24



07025



ΣΚΟΥΠΑ 112

07025 330 x 75mm (BxA) 10



06331



ΣΚΟΥΠΑ 113

06331 300 x 110mm (BxA) 13



06782



ΣΚΟΥΠΑ 115

06782 330 x 75mm (BxA) 13





ΣΚΟΥΠΑ 218

07827	320 x 75mm (BxA)	10



ΣΚΟΥΠΑ 511

07024	330 x 75mm (BxA)	10



ΒΟΥΡΤΣΑ ΠΑΤΩΜΑΤΟΣ

06890	150x25mm (BxA)	12



ΣΚΟΥΠΑ ΠΙΣΣΑΣ 190 ΜΕ ΠΛΑΣΤΙΚΗ ΒΑΣΗ

01531	240mm	10



ΣΚΟΥΠΑ 304

07706	320 x 65mm (BxA)	12



ΣΚΟΥΠΑ ΧΟΡΤΟΥ ΜΕ ΠΛΑΣΤΙΚΗ ΒΑΣΗ

04907	300mm	6
02113	400mm	6



ΣΚΟΥΠΑ ΔΡΟΜΟΥ ΣΥΡΜΑΤΙΝΗ ΜΕ ΠΛΑΣΤΙΚΗ ΒΑΣΗ

Barcode	Icon	Icon
02249	300 mm	6



00326



10011



01540



ΣΚΟΥΠΑ ΔΡΟΜΟΥ PVC ΜΕ ΠΛΑΣΤΙΚΗ ΒΑΣΗ

Barcode	Icon	Icon
00326	300mm	6
10011	400mm	6
01540	600mm	4

GET IT NOW



01354



00953



ΣΚΟΥΠΑ ΔΡΟΜΟΥ ΣΥΡΜΑΤΙΝΗ ΜΕ ΜΕΤΑΛΛΙΚΗ ΒΑΣΗ

Barcode	Icon	Icon
01354	320mm	6
00953	400mm	6



09757



02206



02573

INTER



ΣΚΟΥΠΑ ΔΡΟΜΟΥ PVC ΜΕ ΜΕΤΑΛΛΙΚΗ ΒΑΣΗ

Barcode	Icon	Icon
09757	320mm	6
02206	400mm	6
02573	500mm	6



11244



11245



11246



Αντοχή έως 150Kg



Σκαλοπάτια



Barcode	Model	Step Width (mm)	Step Depth (mm)	Ladder Height (mm)	Weight (kg)
11244	2X2	430mm	485mm	2000mm	1.9
11245	2X3	650mm	720mm	2215mm	2.6
11246	2X4	880mm	945mm	2440mm	3.4



11219



11221



11223



11220



11222



11224



Αντοχή έως 150Kg



Σκαλοπάτια



11219

2+1

420mm

1250mm

570mm

2570mm

3.0

11220

3+1

445mm

1480mm

790mm

2790mm

3.6

11221

4+1

470mm

1720mm

1010mm

3010mm

4.2

11222

5+1

490mm

1955mm

1230mm

3230mm

5.0

11223

6+1

520mm

2190mm

1460mm

3460mm

6.7

11224

7+1

545mm

2420mm

1665mm

3665mm

7.1



11225
11226
11227
11228
11229
11230



>3m



27x27



kg
Αντοχή έως 150Kg

	Σκαλοπάτια				kg
11225	1x8 (2,3m)	362mm	2275mm	3040mm	3.3
11226	1x9 (2,5m)	362mm	2547mm	3290mm	3.5
11227	1x10 (2,8m)	362mm	2835mm	3560mm	4.0
11228	1x12 (3,3m)	362mm	3387mm	4080mm	5.3
11229	1x14 (3,9m)	362mm	3947mm	4610mm	6.2
11230	1x16 (4,5m)	362mm	4507mm	5130mm	7.3

-  11231
-  11232
-  11233
-  11234
-  11235
-  11236
-  11237



Αντοχή έως 150Kg



Σκαλοπάτια



	Σκαλοπάτια								kg
11231	2x7 (2,0m)	460mm	1987mm	3110mm	1905mm	2920mm	3820mm	6.7	
11232	2x8 (2,2m)	460mm	2267mm	3390mm	2165mm	3185mm	4085mm	7.8	
11233	2x9 (2,5m)	460mm	2547mm	3950mm	2420mm	3710mm	4610mm	8.1	
11234	2x10 (2,8m)	460mm	2827mm	4510mm	2710mm	4240mm	5140mm	9.0	
11235	2x11 (3,1m)	460mm	3107mm	5070mm	2980mm	4765mm	5665mm	11.6	
11236	2x12 (3,3m)	460mm	3387mm	5630mm	3230mm	5290mm	6190mm	12.2	
11237	2x13 (3,6m)	460mm	3667mm	6190mm	3470mm	5815mm	6715mm	13.3	



Barcode	Σκαλοπάτια	Width	Length	Height	Span	Height	Height	Weight
11238	3x7 (2,0m)	462mm	1995mm	4240mm	2945mm	4880mm	3845mm	10.3
11239	3x8 (2,3m)	462mm	2275mm	4520mm	3225mm	5445mm	4125mm	11.5
11240	3x9 (2,5m)	462mm	2555mm	5360mm	3780mm	5935mm	4630mm	13.5
11241	3x10 (2,8m)	462mm	2835mm	6210mm	4330mm	6470mm	5200mm	15.8
11242	3x11 (3,1m)	462mm	3115mm	6475mm	4620mm	6985mm	5520mm	18.3



11243



Αντοχή έως 150Kg



11243



Σκαλοπάτια

4x3



980mm



970mm



1725mm



356/334mm



11.85



00937



07418



03266



11606

domit

ΣΚΑΛΟΣΚΑΜΠΟ ΜΕΤΑΛΛΙΚΟ

Barcode	Icon	Step Height	Step Width	Step Depth	Quantity
00937	2 steps	470mm	490mm	820mm	1
03266	3 steps	470mm	650mm	1155mm	1
07418	4 steps	470mm	810mm	1390mm	1
11606	5 steps	470mm	970mm	1625mm	1





tesa



- Η tesa® 4600 είναι μια ισχυρή αυτοβουλκανιζόμενη ταινία κατασκευασμένη από σιλικόνη που συνδέεται χωρίς κόλλα. Εφαρμόζεται περιτυλίγοντας την ταινία γύρω από αυτήν. Η σύνδεση της tesa. 4600 πάνω στο δικό της φορέα δημιουργεί μια στεγανή, μόνιμη σφράγιση. Δεν απαιτείται χρόνος στεγνώματος. Το εύκαμπτο υλικό του μπορεί να εφαρμοστεί ομαλά σε οποιοδήποτε είδος επιφάνειας, συμπεριλαμβανομένων υγρών ή θερμών, βρώμικων ή λιπαρών. Η ταινία μπορεί ακόμη και να εφαρμοστεί κάτω από το νερό. Λόγω της ενίσχυσης από σιλικόνη, η ταινία έχει εξαιρετική αντοχή σε διάφορες χημικές ουσίες, έλαια, οξέα, διαλύτες, αλμυρό νερό, υπερυπόδη ακτινοβολία και ακραίες θερμοκρασίες.
- Μόνωση και προστασία καλωδιώσεων και συνδέσεων.
- Εφαρμογές στεγανοποίησης στο χώρο του κινητήρα.
- Διάφορες εφαρμογές δεματοποίησης, ασφάλισης, συσκευασίας στη ναυτιλία.
- Περιτύλιξη υδραυλικών εξαρτημάτων και άλλων εκτεθειμένων μεταλλικών συνδέσεων για την πρόληψη της διάβρωσης.
- Μασκάρισμα σε εφαρμογές powder coating, ηλεκτροστατικής βαφής, ανοδίωσης και επαργύρωσης.
- Εφαρμογές αυτοκίνησης για περιδέρση καλωδιώσεων και γενικές επισκευές.
- Εφαρμογές ναυτιλίας για ασφάλιση συρματόσχοινων και σχοινιών σε σκάφη.

TAINIA EXTREME CONDITION ΑΥΤΟΒΟΥΛΚΑΝΙΖΟΜΕΝΗ 4600

Barcode	Icon	Box
09509	3m x 25mm Μαύρη	4



09528



09527



09526

tesa



- Ταινία διπλής όψης, ιδιαίτερα συγκολλητική ταινία καθρέφτη, ιδιαίτερα κατάλληλη για την τοποθέτηση επιτοίχιων καθρεφτών σε υγρά περιβάλλοντα. Η ανώτερη συγκολλητική αντοχή της tesa® εξασφαλίζει ότι η ταινία καθρέφτη παρέχει ασφαλή και μακροχρόνια πρόσφυση. Η ταινία καθρέφτη προσφέρει μακροχρόνια αντοχή στη θερμοκρασία στους 80°C, είναι ανθεκτική στο χρόνο, αντισταθμίζει τις τάσεις μεταξύ των υλικών που συγκρατεί και είναι εύκολη στη χρήση.
- Εφαρμογές εσωτερικού και εξωτερικού χώρου.
- Για την τοποθέτηση βαρέων, επίπεδων αντικειμένων όπως καθρέφτες, πινακίδες και διακοσμητικά υλικά.
- Τοποθέτηση διακοσμητικών προφίλ.
- Ιδιαίτερα κατάλληλο για τοποθέτηση καθρεφτών σε περιοχές επιρρεπείς στην υγρασία.

TAINIA ΚΑΘΡΕΠΤΩΝ PRO 66952

Barcode	Icon	Box
09528	1,5m x 19mm	12
09527	5m x 19mm	10
09526	10m x 19mm	16



09641



09642

tesa

- Η ηλεκτρομονωτική ταινία tesaflex 53988 είναι ένας αξιόπιστος βοηθός για ηλεκτρολόγους, μηχανικούς και άλλους τεχνίτες. Χαρακτηρίζεται από υψηλό βαθμό ευκαμψίας και πολύ καλή συγκολλητική συμπεριφορά, όπως και το σχετικά παχύ ενισχυτικό υλικό βάσης(150 μm). Δεδομένου ότι είναι διαθέσιμη σε πολλά χρώματα μπορεί επίσης να χρησιμοποιηθεί ως κολλητική ταινία σήμανσης.
- Ιδανικά κατάλληλη για ηλεκτρικές εφαρμογές, π.χ. μόνωση ή σήμανση καλωδίων.
- Πιστοποίηση IEC 60454-3-1 (VDE, IMQ, SEMKO), πιστοποιημένη με VOC, σύμφωνα προς RoHS 2.0 και REACH.
- Υψηλή διηλεκτρική τάση διάσπασης (7.000 V) - Ανθεκτική στη θερμότητα έως +90°C.

ΜΟΝΩΤΙΚΗ ΤΑΙΝΙΑ 53988 10m X 15mm

Barcode	Icon	Box
09641	Μαύρη	10
09642	Λευκή	10



09533



09534



09536



20m X 19mm

Barcode	Icon	Box
09533	Μαύρη	10
09534	Λευκή	10
09536	Κόκκινη	10



Η Ταινία Διπλής Όψης tesa® Universal είναι μια εξαιρετικά ευέλικτη ταινία διπλής όψης που ταιριάζει σε ένα ευρύ φάσμα εφαρμογών όπως επίστρωση δαπέδου, χειροτεχνία και διακόσμηση σπιτιού. Είναι σε θέση να συνδέει όλους τους τύπους υλικών, υπό την προϋπόθεση ότι έχουν επαρκώς σταθερή, επίπεδη και λεία επιφάνεια. Η ταινία διαθέτει ένα λεπτό πλαστικό φύλλο που μπορεί εύκολα να σχιστεί με το χέρι για γρήγορη και εύκολη εφαρμογή. Παρέχει ισχυρή πρόσφυση και μπορεί να χρησιμοποιηθεί για τη μόνιμη στερέωση διαφορετικών υλικών.



ΤΑΙΝΙΑ ΜΟΚΕΤΩΝ ΔΙΠΛΗΣ ΟΨΗΣ 64620

Barcode	Icon	Box
09523	5m x 50mm	10
09524	10m x 50mm	10
09525	25m x 50mm	10



Επαγγελματική ταινία επισκευών με εξαιρετική αντοχή στην υπεριώδη ακτινοβολία, αδιάβροχη, ισχυρή, ανθεκτική στο χρόνο και στις καιρικές συνθήκες.

- Επισκευή πλαστικών υλικών.
- Επιδιόρθωση μεμβρανών LDPE σε εφαρμογές κατασκευών.
- Σφράγιση πλαστικών σάκων.
- Εσωτερικές και εξωτερικές εφαρμογές.

ΤΑΙΝΙΑ ΘΕΡΜΟΚΗΠΙΟΥ (ΕΠΙΣΚΕΥΩΝ PE) 04668

Barcode	Icon	Box
09636	33m x 50mm	6
09672	33m x 100mm	2



Η ταινία Αλουμινίου tesa® είναι μια ταινία προστασίας ειδικής χρήσης με ανώτερη ισχύ συγκόλλησης. Αυτή η μοναδική ταινία είναι από αλουμίνιο με αυτοκόλλητη επίστρωση, πάντα έτοιμη για επισκευές γρήγορες και ανθεκτικές στο χρόνο.

- Κατάλληλη για προστασία, κάλυψη, μόνωση και επισκευή.
- Μπορεί επίσης να χρησιμοποιηθεί για επισκευές στέγης και υδρορροών.
- Ανθεκτική σε θερμοκρασίες από -40°C έως +160°C.
- Ανθεκτική σε νερό, λάδι και λίπος.
- Ανθεκτική στον χρόνο.
- Υψηλή δύναμη συγκόλλησης.

ΑΛΟΥΜΙΝΟΤΑΙΝΙΑ ΣΩΛΗΝΩΝ

Barcode	Icon	Box
09521	10m x 50mm - code 63652	6
09522	50m x 50mm - code 63632	1





Η tesa® Ηλεκτρομονωτική Ταινία είναι μια ηλεκτρική ταινία PVC που είναι ιδανική για την επισκευή, μόνωση και τύλιγμα όλων των τύπων ηλεκτρικών καλωδίων.

- Για μόνωση και δέσιμο ηλεκτρικών καλωδίων.
- Προστατεύει καλύμματα καλωδίων.
- Επιβραδυντικό φωτιάς.
- Εύκολο τύλιγμα και διαμόρφωση γύρω από ανώμαλες επιφάνειες.
- Ασφαλής προστασία ηλεκτρικής ενέργειας έως 6.000v.
- Πιστοποιημένη σύμφωνα με το πρότυπο IEC 454-3-1.

TAINIA AIRCONDITION 53988

Barcode	Icon	Box
09541	25m x 50mm - Λευκή	4
09542	25m x 50mm - Μαύρη	4



Το tesa® 4688 αποτελεί βασική υφασμάτινη ταινία πολυαιθυλενίου. Βασίζεται σε επιστρωση υφάσματος PET/ρεγιόν υφαντού πλέγματος 55, επικαλυμμένη με συγκολλητικό φυσικού καουτσούκ ευαίσθητο στην πίεση. Το tesa® 4688 αποτελεί συνθησιμένη ταινία επιδιόρθωσης, κατάλληλη για πλήθος αναγκών, με πολύ καλά χαρακτηριστικά διαχείρισης.

- Επισήμανση, επικάλυψη, συσκευασία, προστασία, δέσιμο, κλείσιμο.
- Συνένωση μεμβρανών κατασκευής.
- Κλείσιμο χαρτοκιβωτίων, κονσερβών, κτλ.
- Στερέωση καλωδίων.
- Δεματοποίηση καλωδίων.

TAINIA ΥΦΑΣΜΑΤΙΝΗ GAFFER 04688

Barcode	Icon	Box
09629	25m x 50mm - Μαύρη	5
09630	25m x 50mm - Λευκή	5
09634	25m x 50mm - Γκρι	5
09633	25m x 50mm - Κόκκινη	5



NEW
ARRIVAL



Η υφασμάτινη ταινία tesa® extra Power Universal είναι μια ταινία επισκευών πολλαπλών χρήσεων που χαρακτηρίζεται από εξαιρετικά ισχυρή δύναμη συγκόλλησης. Είναι μια γενική επισκευαστική ταινία για εσωτερικές και εξωτερικές εφαρμογές, είναι επαρκώς ανθεκτική στις καιρικές συνθήκες και κολλάει σχεδόν σε οποιαδήποτε επιφάνεια.

- Για χειροποίητες κατασκευές, επισκευή, στερέωση, τύλιγμα, ενίσχυση, σήμανση και πολλά άλλα.
- Για καθημερινές απλές λύσεις, γρήγορες και εύκολες επισκευές.
- Πολύ καλή πρόσφυση σε όλους τους τύπους επιφανειών.
- Δύναται να σχιστεί με το χέρι.
- Χωρίς διαλύτες.

TAINIA ΥΦΑΣΜΑΤΙΝΗ EXTRA POWER 56348

Barcode	Icon	Box
09516	10m x 50mm - Μαύρη	6
09517	10m x 50mm - Λευκή	6
09515	10m x 50mm - Γκρι	6

TAINIA ΥΦΑΣΜΑΤΙΝΗ EXTRA POWER 56388

Barcode	Icon	Box
09519	25m x 50mm - Μαύρη	6
09520	25m x 50mm - Λευκή	6
09518	25m x 50mm - Γκρι	6





tesa

Ταινία γενικής χρήσης για περίδεση καλωδιώσεων αυτοκινήτων στην καμπίνα των επιβατών.

- Απορρόφηση θορύβου
- Ανθεκτική στην τριβή
- Εύκαμπτη
- Ανθεκτική στο σχίσιμο
- Ανθεκτική στην γήρανση
- Υψηλή συγκολλητική δύναμη
- Κόβεται με το χέρι
- Αντοχή στην θερμοκρασία έως 105°C (3000h)

ΤΑΙΝΙΑ ΥΦΑΣΜΑΤΙΝΗ VLIES 51608

09805	15m x 19mm Μαύρη	8



09491



09492



09493

tesa

Η αυτοκόλλητη ταινία γυψοσανίδας της tesa® 60101 διαθέτει την τελευταία εξέλιξη στην τεχνολογία ταινιών συνένωσης. Με το πολύ ισχυρό και ίσιο πλέγμα από fibreglass, προσφέρει ανθεκτικούς και μακράς διαρκείας αρμούς ξηράς δόμησης/γυψοσανίδας.

Η εξαιρετική πρόσφυση και η πολύ καλή αντοχή σε εφελκυσμό επιτρέπουν με μία μόνο εφαρμογή λείους φινιρισμένους αρμούς.

- Για σύνδεση γυψοσανίδων και επιδιόρθωση ρωγμών και οπών.
- Για σφράγιση αρμών / κενών.
- Έτοιμη προς χρήση χωρίς πρόσθετα ή στόκο.

ΓΑΖΑ ΡΩΓΜΩΝ FIBERGLASS 60101

09491	25m x 48mm	6
09492	45m x 48mm	6
09493	90m x 48mm	6



tesa

Η tesa® PRO Mounting Universal είναι μια απαραίτητη ταινία πολλαπλών χρήσεων για κάθε επαγγελματία τεχνίτη που εργάζεται σε εσωτερικούς χώρους. Στερεώστε ελαφριά αντικείμενα, όπως κανάλια καλωδίων, τοποθέτηση στόκου και σοβατεπί, με ασφάλεια και μόνιμα στις περισσότερες επιφάνειες, χωρίς να αφήνετε τρύπες ή ζημιές στη δομή του τοίχου. Η tesa® PRO Mounting Universal είναι ένα πραγματικό πολυεργαλείο! Μια ασφαλής, έξυπνη λύση για γρήγορες και εύκολες εργασίες.

ΤΑΙΝΙΑ ΣΤΕΡΕΩΣΗΣ ΑΦΡΩΔΗΣ ΓΕΝΙΚΗΣ ΧΡΗΣΗΣ PRO UNIVERSAL 66458

15383	5m x 19mm	8

NEW
ARRIVAL



Η tesa® Pro Mounting Outdoor είναι μια αυτοκόλλητη ταινία διπλής όψης κατάλληλη για ένα ευρύ φάσμα εφαρμογών.

- Ιδανική για εξωτερική χρήση
- Ανθεκτική σε UV, νερό και θερμοκρασία
- Κρατά μέχρι 1 κιλό ανά 10 εκ. ταινία
- Κρατά πάνω σε πλακάκια, τούβλο, πέτρα, μέταλλο και τα περισσότερα πλαστικά.



ΤΑΙΝΙΑ ΣΤΕΡΕΩΣΗΣ ΕΞΩΤΕΡΙΚΗΣ ΧΡΗΣΗΣ 66751

Barcode	Dimensions	Quantity
09530	1,5m x 19mm	12
09531	5m x 19mm	10



Η tesaaflex® 60760 αποτελεί σκληρή πλαστικοποιημένη ταινία PVC, με επικάλυψη δυνατού συγκολλητικού τροποποιημένου καουτσούκ-ρητίνης, το οποίο επιτρέπει προσκόλληση σε πολλές διαφορετικές επιφάνειες. Είναι ιδανική για προσωρινή προειδοποίηση χαμηλού κινδύνου & επισήμανση κινητών ή στατικών αντικειμένων οποιαδήποτε είδους. Το tesaaflex® 60760 μπορεί επίσης να σκιστεί με το χέρι.

ΜΗΧΑΝΙΣΜΟΣ ΤΑΙΝΙΩΝ ΣΥΣΚΕΥΑΣΙΑΣ

Barcode	Code	Quantity
09559	code 06300	1

ΤΑΙΝΙΑ ΣΗΜΑΝΣΗΣ ΑΥΤΟΚΟΛΛΗΤΗ 60760

Barcode	Dimensions	Quantity
09544	33m x 50mm Μαύρη-Κίτρινη	6



Το Drop Cloth tesa® Universal είναι ένα μεγάλο πλαστικό λεπτό φύλλο πολλών χρήσεων που είναι ιδανικό για την προστασία του δαπέδου και των επίπλων κατά τη βαφή και την ανακαίνιση.

- Ανθεκτικό στο σκίσιμο.
- Ανθεκτικό στα γυαλιστερά διαλυτικά.
- Ανθεκτική μεμβράνη PE (πολυαιθυλένιο).

ΝΑΥΛΟΝ ΒΑΨΙΜΑΤΟΣ UNIVERSAL 56651

Barcode	Dimensions	Quantity
09495	4m x 5m (7mic)	20



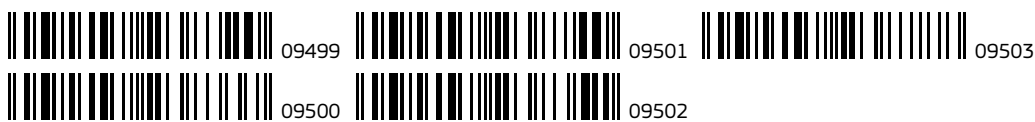

Χαρτοταινίες πολύ καλής ποιότητας που μας επιτρέπουν να δημιουργούμε ακριβείς άκρες βαφής και να καλύπτουμε τέλεια τα σημεία που δεν πρέπει να βαφτούν. Ταινίες που πρέπει πάντα να αποτελούν μέρος του εξοπλισμού μας για το βάψιμο των τοίχων και την ανανεώση του σπιτιού μας.

ΧΑΡΤΟΤΑΙΝΙΑ ΕΠΑΓΓΕΛΜΑΤΙΚΗΣ ΧΡΗΣΗΣ 51023

Barcode	Icon	Icon
09499	50m x 19mm	16
09500	50m x 25mm	12
09501	50m x 30mm	10



Barcode	Icon	Icon
09502	50m x 38mm	8
09503	50m x 50mm	6



Η tesa® 4435 είναι μια ταινία μασκαρίσματος ανθεκτική στην υπεριώδη ακτινοβολία που αποτελείται από ένα υπόστρωμα επικαλυμμένο με μια συγκολλητική μάζα από φυσικό ελαστικό. Η ταινία μασκαρίσματος έχει μια ισορροπημένη δύναμη συγκόλλησης. Είναι εύκολη στη χρήση και μπορεί να σχιστεί με το χέρι. Είναι ιδιαίτερα κατάλληλη για εξωτερικές εργασίες βαφής και σε τραχιές επιφάνειες και μπορεί να χρησιμοποιηθεί μέχρι και 2 εβδομάδες, χάρη στην αντοχή της στην υπεριώδη ακτινοβολία.

Η tesa. 4435 είναι η ιδανική βάση για επαγγελματική και ακριβή εργασία βαφής.

- Εργασίες βαφής και λακάρισμα.
- Κατάλληλη για διάφορες επιφάνειες.

ΧΑΡΤΟΤΑΙΝΙΑ ΜΠΛΕ UV 15 ΗΜΕΡΩΝ 04435

Barcode	Icon	Icon
09504	50m x 25mm	12
09505	50m x 30mm	10



Barcode	Icon	Icon
09506	50m x 38mm	8
09507	50m x 50mm	6



Κορεσμένη ημικρέπ χαρτινή ταινία μασκαρίσματος επικαλυμμένη με κόλλα από φυσικό καουτσούκ. Κατάλληλο για εφαρμογές γενικού μασκαρίσματος.

- Γενικό μασκάρισμα.
- Αφαίρεση χωρίς υπολείμματα.
- Ανθεκτική σε διαλύτη και σε αραιωτικό.
- Σχίζεται εύκολα.
- Κατάλληλη για βαφές με βάση το νερό και διαλύτη.

ΧΑΡΤΟΤΑΙΝΙΑ ΑΚΡΙΒΕΙΑΣ ΕΥΑΙΣΘΗΤΩΝ ΕΠΙΦΑΝΕΙΩΝ 04333

Barcode	Icon	Icon
09489	50m x 30mm	10





Ελαφρώς κρεπαρισμένη χαρτοταινία επικάλυψης για ψεκασμό χρώματος. Είναι λεπτή και εύκαμπτη και συνεπώς, κατάλληλη για όλες τις γενικές εφαρμογές επικάλυψης, καθώς επίσης εφαρμογές ξήρανσης σε θερμοκρασίας έως 80 °C. Προϊόν ανθεκτικό στην υγρή αμμοβολή. Τα χρώματα και τα κονιάματα προσκολλούνται καλά στην επίστρωση. Μπορεί να χρησιμοποιηθεί σε βαμμένο μέταλλο, καουτσούκ, γυαλί και εξαρτήματα χρωμίου.

ΧΑΡΤΟΤΑΙΝΙΑ 80°C 04317

Barcode	Dimensions	Quantity
10256	50m x 19mm	16
10257	50m x 50mm	6



Πολύ κρεπαρισμένη χαρτοταινία επικάλυψης για χρωματισμούς και συσκευασία. Το προϊόν προσφέρει καλή κολλητικότητα. Η τάνση της κρεπ επίστρωσης εγγυάται ομοιόμορφα άκρα χρώματος και καλή προσκόλληση.

ΧΑΡΤΟΤΑΙΝΙΑ ΓΙΑ ΚΑΜΠΥΛΕΣ 04319

Barcode	Dimensions	Quantity
09488	25m x 19mm	18



Ταινίες για αιχμηρές άκρες βαφής που κολλούν εξαιρετικά ευθυγραμμισμένα στην επιφάνεια για την αποτροπή διαρροής χρώματος. Είναι απολύτως ιδανικές για εφαρμογές διχρωμίας, π.χ. ίσιες και μακριές γραμμές, εύκαμπτες και αφαιρούνται εύκολα.

ΧΑΡΤΟΤΑΙΝΙΑ ΑΚΡΙΒΕΙΑΣ 04344

Barcode	Dimensions	Quantity
09490	50m x 30mm	5
14758	50m x 38mm	4
14999	50m x 50mm	3



NEW
ARRIVAL



Η Αντιολισθητική Ταινία tesa® είναι ένα έξυπνο και αποτελεσματικό μέσο για την πρόληψη πτώσης σε σκαλοπάτια, ράμπες, ολισθηρά δάπεδα ή κύπη σκαφών. Βοηθά στην πρόληψη ατυχημάτων και συμβάλλει στην ισχυρή και ανθεκτική πρόσφυση. Είναι επίσης ανθεκτικό στην υπεριώδη ακτινοβολία UV και εξαιρετικά ανθεκτικό έναντι του νερού, των ακραίων θερμοκρασιών και των καθαριστικών. Μπορείτε εύκολα να κόψετε την ταινία με το χέρι για να ταιριάζει στην συγκεκριμένη ανάγκη σας. Θα επικοληθεί με ασφάλεια σε κάθε επίπεδη επιφάνεια που είναι απαλλαγμένη από βρωμιά, λάδι και λίπος.

ΤΑΙΝΙΑ ΑΝΤΙΟΛΙΣΘΗΤΙΚΗ 5m X 25mm 55587

Barcode	Color	Quantity
09548	Διάφανη	6
09549	Μαύρη	6



5m X 50mm 55588

Barcode	Color	Quantity
09550	Μαύρη	6



Η αντιολισθητική σειρά της tesa® Professional εφαρμόζεται παντού για να διασφαλισθεί ασφαλές πάτημα. Η μαύρη αντιολισθητική είναι η ιδανική προστασία για την αποφυγή της ολίσθησης και ως εκ τούτου βοηθά στην αποφυγή ατυχημάτων στη σχετική εργασία. Η πολύ καλή πρόσφυση του προϊόντος είναι κατάλληλη για απαιτητικές επιφάνειες, όπως εργοστασιακά δάπεδα, βιομηχανικές επιφάνειες κλπ. Η ισχυρή και ανθεκτική συγκολλητική επίστρωση εξασφαλίζει ένα υψηλό αντιολισθητικό αποτέλεσμα έως και 1-2 χρόνια σε περιοχές κανονικής χρήσης. Οι αντιολισθητικές ταινίες σκίζονται με το χέρι και δεν παρουσιάζουν συρρίκνωση μετά την εφαρμογή.

ΤΑΙΝΙΑ ΑΝΤΙΟΛΙΣΘΗΤΙΚΗ ΜΑΥΡΗ 60950

Barcode	Dimensions	Quantity
09545	15m x 25mm	6
09546	15m x 50mm	3



Η αντιολισθητική σειρά της tesa® Professional εφαρμόζεται παντού για να διασφαλισθεί ασφαλές πάτημα. Η μαύρη αντιολισθητική είναι η ιδανική προστασία για την αποφυγή της ολίσθησης και ως εκ τούτου βοηθά στην αποφυγή ατυχημάτων στη σχετική εργασία. Η πολύ καλή πρόσφυση του προϊόντος είναι κατάλληλη για απαιτητικές επιφάνειες, όπως εργοστασιακά δάπεδα, βιομηχανικές επιφάνειες κλπ. Η ισχυρή και ανθεκτική συγκολλητική επίστρωση εξασφαλίζει ένα υψηλό αντιολισθητικό αποτέλεσμα έως και 1-2 χρόνια σε περιοχές κανονικής χρήσης. Οι αντιολισθητικές ταινίες σκίζονται με το χέρι και δεν παρουσιάζουν συρρίκνωση μετά την εφαρμογή.

ΤΑΙΝΙΑ ΑΝΤΙΟΛΙΣΘΗΤΙΚΗ ΜΑΥΡΗ-ΚΙΤΡΙΝΗ 60951

Barcode	Dimensions	Quantity
09547	15m x 50mm	3



tesa
MOLL
ALU
COMFORT
8 YEARS
15 mm

09579 1m x 15mm (μήκος x κενό) Λευκό 5

tesa
MOLL
DOUBLE ROLL
05418

09586 0,95m x 22mm (μήκος x κενό) 5

tesa
MOLL
UNIVERSAL
2 YEARS
20 mm

09588 1m x 20mm (μήκος x κενό) Καφέ 10
09587 1m x 20mm (μήκος x κενό) Λευκό 10

tesa

09591 Λευκό (57533) 6
09592 Ματ Χρωμέ (57519) 6



MGI



ΕΚΘΕΤΗΡΙΟ ΓΙΑ ΤΑΙΝΙΕΣ

Barcode	Icon	Volume
11605	170x62x26cm - code 98750	1



11602



11603

MGI



Ταινία κατάλληλη στις κατασκευές με γυψοσανίδα. Χρησιμοποιείται για την ενίσχυση των ρωγμών και στις συνδέσεις των αρμών.

ΓΑΖΑ ΡΩΓΜΩΝ FIBERGLASS

Barcode	Icon	Volume
11602	20m x 50mm - code 98020FG	6
11603	50m x 50mm - code 98050FG	6



MGI



Πανίσχυρη αυτοκόλλητη ταινία montage. Ιδανική για τη στήριξη σε μέταλλο, γυαλί, πλαστικό ξύλο, καθρέπτη κτλ. Κατάλληλη για τη βιομηχανία αυτοκινήτων. Άμεση συγκόλληση, διαφανής, ανθεκτική στη θερμότητα. Εσωτερική και εξωτερική χρήση.
Στήριξη αντικειμένων:
Λεία επιφάνεια 1cm / 2kg -
Τραχιά επιφάνεια 1cm / 0,6kg.

ΤΑΙΝΙΑ ΑΚΡΥΛΙΚΗ MONTAGE

Barcode	Icon	Volume
13571	3m x 19mm - code 98773	6



11590



11592



11591

MGI



Ταινία με αντοχή στην ηλιακή ακτινοβολία και σε θερμοκρασίες έως 60οC. Δεν αφήνει υπολείμματα κόλλας για 14ημέρες. Κατάλληλη για εξωτερικούς και εσωτερικούς χώρους.

ΧΑΡΤΟΤΑΙΝΙΑ ΜΠΛΕ UV

Barcode	Icon	Volume
11590	40m x 30mm - code 97130UV	6
11591	40m x 38mm - code 97138UV	6
11592	40m x 48mm - code 97148UV	6



Ταινία με ακρυλική κόλλα και αντοχή σε θερμοκρασίες από -30°C έως +85°C. Κατάλληλη για επιδιόρθωση και κάλυψη μπουριών σόμπας, σωλήνων air condition και σωληνώσεις μεταφοράς αέρος.

ΑΛΟΥΜΙΝΟΤΑΙΝΙΑ ΣΩΛΗΝΩΝ ΑΣΗΜΙ

Barcode	Icon	Icon
02100	5m x 48mm - code 972055	6
02317	10m x 48mm - code 972105	6
12293	50m x 48mm - code 972505	6



GET IT NOW

HOT SELLER

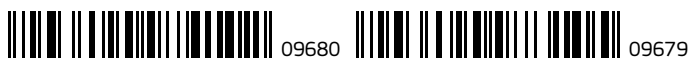

Ταινία με ακρυλική κόλλα και αντοχή σε θερμοκρασίες από -30°C έως +85°C. Κατάλληλη για επιδιόρθωση και κάλυψη μπουριών σόμπας, σωλήνων air condition και σωληνώσεις μεταφοράς αέρος.

ΑΛΟΥΜΙΝΟΤΑΙΝΙΑ ΣΩΛΗΝΩΝ ΕΜΑΓΙΕ

Barcode	Icon	Icon
09680	10m x 48mm Καφέ - code 97410BR	6
09679	10m x 48mm Μαύρη - code 97310B	6



HOT SELLER



Ταινία διπλής όψεως με ισχυρή κόλλα. Ύφανση 70mesh για καλύτερη πρόσφυση στο δάπεδο. Κατάλληλη για χρήση σε επαγγελματικούς χώρους, σπίτια, ξενοδοχεία κλπ.

ΤΑΙΝΙΑ ΜΟΚΕΤΩΝ ΕΠΑΓΓΕΛΜΑΤΙΚΗ ΔΙΠΛΗΣ ΟΨΗΣ

Barcode	Icon	Icon
11593	25m x 50mm - code 97525C	6



Ταινία PP διπλής όψεως που προσφέρει ισχυρή κόλληση. Κατάλληλη για την επικόλληση χαλιών-μοκετών, αφισών, φακέλων, παιχνιδιών, κρέμασμα πινακίδων καθώς και για χρήση στην εσωτερική διακόσμηση σπιτιών.

ΤΑΙΝΙΑ ΜΟΚΕΤΩΝ ΔΙΠΛΗΣ ΟΨΗΣ

Barcode	Icon	Icon
02584	5m x 38mm - code 97505PP	6
01831	10m x 38mm - code 97510PP	6





11594



11595



11596



Ταινία διπλής όψεως από υψηλών προδιαγραφών αφρώδες υλικό EVA. Κατάλληλη για τη στήριξη μικρών καθρεπτών στο σπίτι, σε επαγγελματικούς χώρους, εκθέσεις κλπ.

ΤΑΙΝΙΑ ΚΑΘΡΕΠΤΩΝ

Barcode	Icon	Icon
11594	5m x 19mm - code 97605F	6
11595	10m x 19mm - code 97610F	6
11596	15m x 19mm - code 97615F	6



11597



11599



11601



11598



11600



Ταινία κατάλληλη για σκάλες, μπάνια, αποθήκες κλπ.

ΤΑΙΝΙΑ ΑΝΤΙΟΛΙΣΘΗΤΙΚΗ ΜΑΥΡΗ

Barcode	Icon	Icon
11597	5m x 25mm - code 97805	6
11598	5m x 50mm - code 97905	6
11599	20m x 19mm - code 97720	6
11600	20m x 25mm - code 97820	6
11601	20m x 50mm - code 97920	6



Οικονομική ταινία συσκευασίας με ισχυρή κόλλα. Κατάλληλη για χαρτοκιβώτια, παλέτες κλπ.

ΤΑΙΝΙΑ ΣΥΣΚΕΥΑΣΙΑΣ ΔΙΑΦΑΝΗ

Barcode	Icon	Icon
03612	50m x 48mm - code 96550N	6



HOT
SELLER



Οικονομική ταινία συσκευασίας με ισχυρή κόλλα. Κατάλληλη για χαρτοκιβώτια, παλέτες κλπ.

ΤΑΙΝΙΑ ΣΥΣΚΕΥΑΣΙΑΣ ΚΑΦΕ

Barcode	Icon	Icon
03611	50m x 48mm - code 96450N	6





MGI

Ταινία συσκευασίας με ισχυρή κόλλα και αθόρυβο ξετύλιγμα.
Κατάλληλη για επαγγελματική χρήση, χαρτοκιβώτια, παλέτες κλπ.

ΤΑΙΝΙΑ ΣΥΣΚΕΥΑΣΙΑΣ ΔΙΑΦΑΝΗ ΧΑΜΗΛΟΥ ΘΟΡΥΒΟΥ

06624	60m x 48mm - code 96160L	6



MGI

Ταινία συσκευασίας με ισχυρή κόλλα και αθόρυβο ξετύλιγμα.
Κατάλληλη για επαγγελματική χρήση, χαρτοκιβώτια, παλέτες κλπ.

ΤΑΙΝΙΑ ΣΥΣΚΕΥΑΣΙΑΣ ΚΑΦΕ ΧΑΜΗΛΟΥ ΘΟΡΥΒΟΥ

11588	60m x 48mm - code 96060L	6



MGI

Ταινία "ΕΥΘΡΑΥΣΤΟ" κατάλληλη για τη σήμανση ευπαθών προϊόντων.

ΤΑΙΝΙΑ ΣΥΣΚΕΥΑΣΙΑΣ ΕΥΘΡΑΥΣΤΟΝ

11589	50m x 48mm - code 96750L	6



INTER

ΜΗΧΑΝΙΣΜΟΣ ΤΑΙΝΙΩΝ ΣΥΣΚΕΥΑΣΙΑΣ

06418	code 792201	1





Ταινία κατάλληλη για εργοστάσια, αποθήκες, αεροδρόμια, εμπορικά κέντρα κλπ. Κατάλληλη για τη προειδοποίηση και τη σήμανση κινδύνου, διαχωρισμό τμημάτων, κωδικοποίηση κλπ.

ΤΑΙΝΙΑ ΣΗΜΑΝΣΗΣ ΑΥΤΟΚΟΛΛΗΤΗ

Barcode	Icon	Icon
11604	33m x 50mm - code 98133	6



Αυτοκόλλητη ασφαλική ταινία με επένδυση αλουμινίου και ισχυρή συγκόλληση. Κατάλληλη για τη σφράγιση στη βάση των καμινάδων, στα πλαίσια στήριξης των φεγγιτών, στη βάση των σωλήνων εξαερισμού, στις εσοχές σκεπών κτλ. Είναι αδιάβροχη με αντοχή σε θερμοκρασίες από -25°C έως +70°C.

ΑΛΟΥΜΙΝΟΤΑΙΝΙΑ ΜΟΝΩΣΕΩΣ ΑΣΗΜΙ

Barcode	Icon	Icon
12032	100mm x 10m - code 98610	8
12033	150mm x 10m - code 98615	8
12034	200mm x 10m - code 98620	4
12035	300mm x 10m - code 98630	4



ΑΛΟΥΜΙΝΟΤΑΙΝΙΑ ΜΟΝΩΣΕΩΣ ΚΕΡΑΜΙΔΙ

Barcode	Icon	Icon
12038	150mm x 10m - code 98655	8
12040	300mm x 10m - code 98663	4
14059	600mm x 10m - code 98676	1

05486	06788
10670	09619
02974	09423
00621	05487
00044	05488
03039	06797
05079	09450
05619	09620
14693	
10671	
09422	
02208	
00673	
06317	



Αυτοκόλλητη ασφαλική ταινία με επένδυση αλουμινίου. Αντοχή στην υγρασία, το νερό, την ηλιακή ακτινοβολία και σε θερμοκρασίες από -40°C έως +80°C. Ενδείκνυται για γρήγορες στεγανοποιήσεις και επισκευές αρμών χωρίς χρήση ασταριού σε διάφορα υποστρώματα. Κατάλληλη για επιδιορθώσεις σε καμινάδες, στηθαία, υδρορροές, φεγγίτες, λούκια, κεραμοσκεπές.

ΑΛΟΥΜΙΝΟΤΑΙΝΙΑ ΜΟΝΩΣΕΩΣ ΑΣΗΜΙ

Barcode	Icon	Icon
05486	50mm x 10m	6
10670	75mm x 10m	4
02974	100mm x 10m	3
00621	150mm x 10m	2
00044	200mm x 10m	1
03039	300mm x 10m	1
05079	600mm x 10m	1
05619	900mm x 10m	1

ΑΛΟΥΜΙΝΟΤΑΙΝΙΑ ΜΟΝΩΣΕΩΣ ΚΕΡΑΜΙΔΙ

Barcode	Icon	Icon
14693	50mm x 10m	6
10671	75mm x 10m	4
09422	100mm x 10m	3
02208	150mm x 10m	2
00673	200mm x 10m	1
06317	300mm x 10m	1
06788	600mm x 10m	1
09619	900mm x 10m	1

ΑΛΟΥΜΙΝΟΤΑΙΝΙΑ ΜΟΝΩΣΕΩΣ ΜΠΕΖ

Barcode	Icon	Icon
09423	100mm x 10m	3
05487	150mm x 10m	2
05488	200mm x 10m	1
06797	300mm x 10m	1
09450	600mm x 10m	1
09620	900mm x 10m	1



10008

11481

Den Braven



ΤΑΙΝΙΑ ON & OFF

10008	50cm x 20mm Λευκή	6
11481	50cm x 20mm Μαύρη	6



14015

14722

Den Braven

NEW
ARRIVAL



ΤΑΙΝΙΑ ΜΠΑΝΙΟΥ ΛΕΥΚΗ

14015	2,4m x 22mm	5
14722	2,4m x 40mm	3



09973

09977



09976

Den Braven



ΤΑΙΝΙΑ ΑΝΤΙΟΛΙΣΘΗΤΙΚΗ ΜΑΥΡΗ

09973	4,5m x 25mm	6
09976	18m x 25mm	2
09977	18m x 50mm	2



09972

09974



ΤΑΙΝΙΑ ΑΝΤΙΟΛΙΣΘΗΤΙΚΗ ΔΙΑΦΑΝΗ

09972	4,5m x 25mm	6
09974	4,5m x 50mm	6



NEW
ARRIVAL

GET IT
NOW

HOT
SELLER

ΧΑΡΤΟΤΑΙΝΙΑ ΓΕΝΙΚΗΣ ΧΡΗΣΗΣ

Barcode	Dimensions	Quantity
14685	40m x 19mm	16
14686	40m x 25mm	12
14687	40m x 30mm	10
14688	40m x 38mm	8
14689	40m x 50mm	6



HOT
SELLER

NEW
ARRIVAL

ΤΑΙΝΙΑ ΣΥΣΚΕΥΑΣΙΑΣ ΔΙΑΦΑΝΗ

Barcode	Dimensions	Quantity
14452	50m x 48mm	36



NEW
ARRIVAL

ΤΑΙΝΙΑ ΣΥΣΚΕΥΑΣΙΑΣ ΔΙΑΦΑΝΗ ΧΑΜΗΛΟΥ ΘΟΡΥΒΟΥ

Barcode	Dimensions	Quantity
14453	60m x 48mm	36



GET IT
NOW

NEW
ARRIVAL

ΤΑΙΝΙΑ ΣΥΣΚΕΥΑΣΙΑΣ ΚΑΦΕ

Barcode	Dimensions	Quantity
14451	50m x 48mm	36



NEW
ARRIVAL

ΤΑΙΝΙΑ ΣΥΣΚΕΥΑΣΙΑΣ ΚΑΦΕ ΧΑΜΗΛΟΥ ΘΟΡΥΒΟΥ

Barcode	Dimensions	Quantity
14454	60m x 48mm	36



NEW
ARRIVAL

ΤΑΙΝΙΑ ΣΥΣΚΕΥΑΣΙΑΣ ΕΥΘΡΑΥΣΤΟΝ

Barcode	Icon	Icon
14450	50m x 50mm	72



ΤΑΙΝΙΑ ΣΤΕΡΕΩΣΗΣ ΑΦΡΩΔΗΣ

Barcode	Icon	Icon
09835	5m x 19mm	48



Ταινία με αντοχή στην ηλιακή ακτινοβολία. Δεν αφήνει υπολείμματα κόλλας για 15 ημέρες. Κατάλληλη για εξωτερικούς και εσωτερικούς χώρους.

ΧΑΡΤΟΤΑΙΝΙΑ ΜΠΛΕ UV 15ΗΜΕΡΩΝ

Barcode	Icon	Icon
09261	45m x 19mm	16
09262	45m x 25mm	12
09263	45m x 30mm	10
09264	45m x 38mm	8
09265	45m x 50mm	6

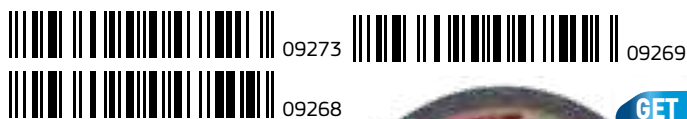

GET IT
NOW



ΤΑΙΝΙΑ ΥΦΑΣΜΑΤΙΝΗ 10m X 48mm

Barcode	Icon	Icon
09273	Γκρι	10
09268	Λευκή	10
09269	Μαύρη	10



ΤΑΙΝΙΑ AIR-CONDITION ΑΥΤΟΚΟΛΛΗΤΗ 18m X 48mm

Barcode	Icon	Icon
05577	Λευκή	4
11533	Μαύρη	4



GET IT
NOW

ΤΑΙΝΙΑ ΤΡΟΜΟΥ ΠΟΥΛΙΩΝ

Barcode	Icon	Icon
12713	100m x 50mm	6



ΤΑΙΝΙΑ AIR-CONDITION ΛΕΥΚΗ ΧΩΡΙΣ ΚΟΛΛΑ

Barcode	Icon	Icon
14109	18m x 45mm	4



02026



04659



04660

Morgan.**ΜΟΝΩΤΙΚΗ ΤΑΙΝΙΑ 20m X 19mm**

Barcode	Color	Quantity
02026	Κόκκινη	40
04660	Λευκή	40
04659	Μαύρη	40



GET IT NOW



06125



13778

**ΜΕΜΒΡΑΝΗ STRETCH ΧΕΙΡΟΣ 50cm**

Barcode	Color	Quantity
06125	Διάφανη	6
13778	Μαύρη	6



HOT SELLER



05281



05282

**ΤΑΙΝΙΑ ΘΕΡΜΟΚΗΠΙΟΥ**

Barcode	Dimensions	Quantity
05281	25m x 50mm	6
05282	25m x 100mm	3

**GEKO****ΤΑΙΝΙΑ ΣΗΜΑΝΣΗΣ ΔΡΟΜΩΝ & ΕΡΓΩΝ**

Barcode	Dimensions	Quantity
01717	200m x 70mm	6



HOT SELLER

ΤΕΦΛΟΝ - ΤΣΟΧΑΚΙΑ - ΑΕΡΟΣΤΟΠ

01698
08534

Morgan.



ΤΕΦΛΟΝ

Barcode	Icon	Volume
01698	10m x 12mm	10
08534	15m x 19mm	10

05109
06953
06954



ΤΣΟΧΑΚΙΑ ΣΤΡΟΓΓΥΛΑ

Barcode	Icon	Volume
05109	24mm x 18τμχ	16
06953	30mm x 12τμχ	16
06954	35mm x 8τμχ	16

13467 13465
13468 13466

GEKO

για κενό
1-3,5mm

**ΑΕΡΟΣΤΟΠ (Ε)
ΡΟΛΟ 100m**

Barcode	Icon	Volume
13467	Καφέ	1
13468	Λευκό	1

**ΑΕΡΟΣΤΟΠ (Ε)
ΡΟΛΟ 6m**

Barcode	Icon	Volume
13465	Καφέ	2
13466	Λευκό	2



13471 13469
13472 13470

GEKO

για κενό
2-5mm

**ΑΕΡΟΣΤΟΠ (Ρ)
ΡΟΛΟ 100m**

Barcode	Icon	Volume
13471	Καφέ	1
13472	Λευκό	1

**ΑΕΡΟΣΤΟΠ (Ρ)
ΡΟΛΟ 6m**

Barcode	Icon	Volume
13469	Καφέ	2
13470	Λευκό	2



GEKO



ΒΕΡΓΑ ΠΟΡΤΑΣ DOUBLE STOP 0,95m

Barcode	Icon	Volume
13473	Γκρι	5

GET IT NOW

04313 02318

GEKO



ΒΕΡΓΑ ΠΟΡΤΑΣ ΜΕ ΒΟΥΡΤΣΑΚΙ 1m

Barcode	Color	Quantity
04313	Καφέ	25
02318	Λευκή	25

09266 09267



ΒΕΡΓΑ ΠΟΡΤΑΣ ΜΕ ΛΑΣΤΙΧΟ

Barcode	Color	Quantity
09266	Λευκή	24
09267	Καφέ	24

04331 02596

GEKO



ΒΕΡΓΑ ΠΟΡΤΑΣ ΑΠΛΗ 1m

Barcode	Color	Quantity
04331	Λευκή	50
02596	Καφέ	50

02319 02321
02320 02322

GEKO

ΑΕΡΟΣΤΟΠ

Barcode	Size	Quantity	Barcode	Size	Quantity
02319	15mm x 8m	34	02321	25mm x 8m	20
02320	20mm x 8m	25	02322	30mm x 4m	34



15385

GEKO



NEW ARRIVAL

ΤΑΙΝΙΑ ΕΠΙΣΚΕΥΗΣ ΡΩΓΜΩΝ

Barcode	Size	Quantity
15385	10m x 50mm	6





ΣΦΗΝΑ ΘΥΡΩΝ «STOP» ΣΕΤ 2 ΤΕΜΑΧΙΩΝ

		
09145	Blister	20





ΚΟΥΡΤΙΝΑ ΜΠΑΝΙΟΥ

		
06409	180 x 180cm - code H24	6









ΒΕΡΓΑ ΑΛΟΥΜΙΝΙΟΥ ΚΟΥΡΤΙΝΑΣ ΜΠΑΝΙΟΥ

		
06391	120-220cm Λευκή	5
06793	120-220cm Ασημί	5





ΒΕΡΓΑ ΑΛΟΥΜΙΝΙΟΥ ΓΩΝΙΑΚΗ ΚΟΥΡΤΙΝΑΣ ΝΤΟΥΖΙΕΡΑΣ

		
06670	80x80cm	5





ΙΜΑΝΤΑΣ ΠΑΡΑΘΥΡΩΝ

		
13266	7m x 2cm	1
13267	50m x 2cm	5





ΙΜΑΝΤΑΣ ΠΑΡΑΘΥΡΩΝ ΜΕ ΛΕΥΚΗ ΤΑΜΠΑΚΙΕΡΑ

		
13268	6m x 1,4cm	5

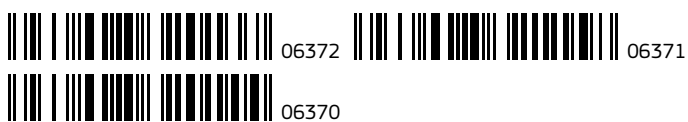

INTER



ΓΡΑΜΜΑΤΟΚΙΒΩΤΙΟ 300x210x60mm

Barcode	Color	Quantity
06372	Λευκό	6
06370	Μαύρο	6
06371	Πράσινο	6

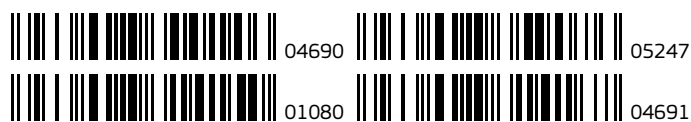

INTER



ΓΡΑΜΜΑΤΟΚΙΒΩΤΙΟ 360x230x90mm

Barcode	Color	Quantity
04690	Λευκό	6
01080	Μαύρο	6
05247	Μπλε	6
04691	Πράσινο	6



ΒΑΣΗ ΤΗΛΕΟΡΑΣΗΣ ΜΑΥΡΗ

Barcode	Size	Quantity
02257	17"	4
06950	25"	4



ΖΥΓΑΡΙΑ ΚΑΘΙΣΤΗ ΜΕ ΠΙΑΤΟ CAMRY

Barcode	Weight	Quantity
05435	5kg	2
03409	10kg	2
03410	20kg	2
09859	Τζάμι πλαστικό	1
09858	Πιάτο	1
09860	Βάση σταυρού	1



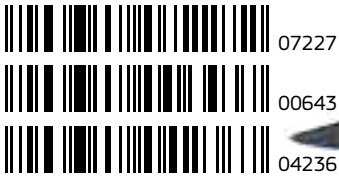

ΖΥΓΑΡΙΑ ΚΑΘΙΣΤΗ ΜΕ ΠΛΑΚΑ CAMRY

Barcode	Weight	Quantity
07227	25kg	2
00643	50kg	2
04236	Τζάμι πλαστικό	1

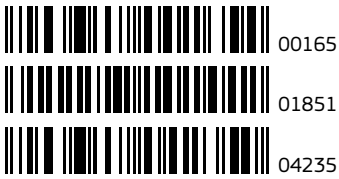

ΚΑΝΤΑΡΙΑ ΡΟΛΟΪ CAMRY

Barcode	Weight	Quantity
00165	50kg	2
01851	100kg	2
04235	Τζάμι πλαστικό	1

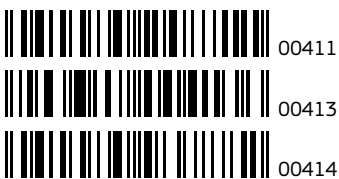

ΚΑΝΤΑΡΑΚΙ ΓΕΡΜΑΝΙΑΣ

Barcode	Weight	Quantity
00411	12,5kg	12
00413	25kg	6
00414	50kg	6



ΕΚΘΕΤΗΡΙΟ ΜΑΧΑΙΡΙΩΝ

Barcode	Dimensions	Quantity
11544	185 x 65 x 36cm	1





ΜΑΧΑΙΡΑ ΚΑΜΠΟΥΡΩΤΗ

		
05140		1





ΜΑΧΑΙΡΑ ΑΤΣΑΛΙ

		
01544	1	5
02124	1.5	5





ΜΑΧΑΙΡΑ (ΜΙΣΟΤΣΑΤΗΡΟ) ΑΤΣΑΛΙ

		
01545	2	5
01503	3	5
01504	4	5
00121	5	5





ΜΑΧΑΙΡΑ (ΤΣΑΤΗΡΑ) ΑΤΣΑΛΙ

		
02966	6	6
02967	7	6
03275	8	5
05137	9	5









05030 05028
05027 05029

ICEL®









ΜΑΧΑΙΡΑ ΙΝΟΧ

		
05030	391.4115.32	2
05027	391.4116.27	2
05028	391.4116.30	2
05029	391.4116.34	2



ΜΑΣΑΤΙ ΚΙΝΑΣ

		
00890	12"(300mm)	2

02523 01150

ΜΑΣΑΤΙ ΓΕΡΜΑΝΙΑΣ

		
02523	10" (250mm)	1
01150	12" (300mm)	1







ΜΟΥΣΤΑΣ ΙΝΟΧ

		
06927	1000gr	5

05450 03881
03880

GET IT NOW

ΜΑΧΑΙΡΙ ΦΑΡΔΥ ΠΛΑΣΤΙΚΗ ΛΑΒΗ

Barcode	SKU	Quantity
05450	243.9751.11	6
03880	243.9751.14	6
03881	243.9751.16	6

03043 03648
03647

GET IT NOW



ΜΑΧΑΙΡΙ ΦΑΡΔΥ ΞΥΛΙΝΗ ΛΑΒΗ

Barcode	SKU	Quantity
03043	231.9751.11	6
03647	231.9751.14	6
03648	231.9751.16	6

GET IT NOW



ΜΑΧΑΙΡΙ ΠΛΑΣΤΙΚΗ ΛΑΒΗ

Barcode	SKU	Quantity
03649	243.3139.15	6

GET IT NOW



ΜΑΧΑΙΡΙ ΨΩΜΙΟΥ

Barcode	SKU	Quantity
05031	231.5382.18	6

06138 03646

GET IT NOW



ΜΑΧΑΙΡΙ ΞΕΚΟΚΑΛΙΣΜΑΤΟΣ ΠΛΑΣΤΙΚΗ ΛΑΒΗ

Barcode	SKU	Quantity
06138	243.3918.13	6
03646	243.3918.15	6

04700 03712

GET IT NOW



ΜΑΧΑΙΡΙ ΞΕΚΟΚΑΛΙΣΜΑΤΟΣ ΞΥΛΙΝΗ ΛΑΒΗ

Barcode	SKU	Quantity
04700	233.3918.13	6
03712	233.3918.15	6

	00971		03641
	00970		03642
	03755		03643
	03639		03644
	03640		

GET IT NOW



ΜΑΧΑΙΡΙΑ ΠΛΑΣΤΙΚΗ ΛΑΒΗ

00971	243.3100.10	12
00970	243.3100.12	12
03755	243.3100.13	12
03639	243.3100.14	12
03640	243.3100.15	6
03641	243.3100.17	6
03642	243.3100.18	6
03643	243.3100.19	6
03644	243.3100.20	6



GET IT NOW



ΜΑΧΑΙΡΙ ΓΕΝΙΚΗΣ ΧΡΗΣΗΣ ΠΛΑΣΤΙΚΗ ΛΑΒΗ

10664	243.5015.12	12



GET IT NOW



ΜΑΧΑΙΡΙΑ ΞΕΦΛΟΥΔΙΣΜΑΤΟΣ

10663	243.3038.08	12

	03630		03635
	03631		03636
	03632		03637
	03633		03638
	03634		

GET IT NOW



ΜΑΧΑΙΡΙΑ ΞΥΛΙΝΗ ΛΑΒΗ

03630	231.3100.10	12
03631	231.3100.12	12
03632	231.3100.13	12
03633	231.3100.14	12
03634	231.3100.15	6
03635	231.3100.17	6
03636	231.3100.18	6
03637	231.3100.19	6
03638	231.3100.20	6



GET IT NOW



ΜΑΧΑΙΡΙΑ ΛΑΧΑΝΙΚΩΝ

10662	244.3200.08	12

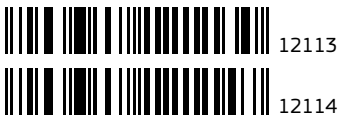

GET IT NOW



**ΜΑΧΑΙΡΙ ΞΕΚΟΚΑΛΙΣΜΑΤΟΣ
ΓΥΡΙΣΤΟ ΠΛΑΣΤΙΚΗ ΛΑΒΗ**

12113	241.3855.13	6
12114	241.3855.15	6

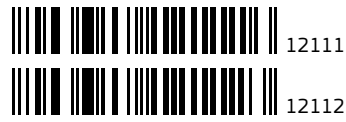

GET IT NOW



**ΜΑΧΑΙΡΙ ΞΕΚΟΚΑΛΙΣΜΑΤΟΣ
ΓΥΡΙΣΤΟ ΠΛΑΣΤΙΚΗ ΛΑΒΗ**

12111	286.3857.13	6
12112	286.3857.15	6



**ΕΚΘΕΤΗΡΙΟ ΜΑΧΑΙΡΙΩΝ
2446 ΜΕ ΘΗΚΗ**

11177	Σετ. 15 τμχ.	1



**ΣΟΥΓΙΑΣ
ΠΟΛΛΑΠΛΩΝ ΧΡΗΣΕΩΝ ΤΑΪΒΑΝ**

01514		12



BLISTER

GET IT NOW

**ΚΟΦΤΗΣ
ΜΟΚΕΤΑΣ
4510**



05592	Μεταλλικός, 18mm	12

**ΛΕΠΙΔΙ
ΜΟΚΕΤΑΣ 4570**



05599	Σετ 10 τμχ., 18mm	36



ΣΟΥΓΙΑΣ ΤΑΪΒΑΝ

06400	7"	12



ΚΟΦΤΕΣ ΜΟΚΕΤΑΣ



BELLOTA



ΚΟΦΤΗΣ ΜΟΚΕΤΑΣ ΤΙΤΑΝΙΟΥ

07213	51406-18, 18mm	12
07216	Ανταλλακτικές Λάμες	10



BELLOTA



ΚΟΦΤΗΣ ΜΟΚΕΤΑΣ

07215	51407-18, 18mm	12
07219	Ανταλλακτικές Λάμες	10



BELLOTA



ΚΟΦΤΗΣ ΜΟΚΕΤΑΣ

07214	51404-18, 18mm	12
07218	Ανταλλακτικές Λάμες	10



BELLOTA



ΚΟΦΤΗΣ ΜΟΚΕΤΑΣ

09224	51405-25, 25mm	12
09225	Ανταλλακτικές Λάμες	10



KDS



ΚΟΦΤΗΣ ΜΟΚΕΤΑΣ G-11YE

Περιέχει 2 επιπλέον ανταλλακτικές λάμες

13533	18mm	10



KDS



ΚΟΦΤΗΣ ΜΟΚΕΤΑΣ GC-401

Περιέχει 2 επιπλέον ανταλλακτικές λάμες

13534	18mm	20



KDS



ΚΟΦΤΗΣ ΜΟΚΕΤΑΣ L22

Περιέχει 2 επιπλέον ανταλλακτικές λάμες

13537	18mm	10



KDS



**ΚΟΦΤΗΣ ΜΟΚΕΤΑΣ ΗΚ-11
ΜΕ ΛΑΜΑ ΓΑΝΤΖΟΥ**

13721	18mm	10



KDS



GET IT NOW

**ΚΟΦΤΕΣ ΜΟΚΕΤΑΣ
ΣΕ ΕΚΘΕΤΗΡΙΟ 20 ΤΜΧ.**

13538	18mm	1



GET IT NOW



ΚΟΦΤΗΣ ΜΟΚΕΤΑΣ

03185	18mm	48



ΚΟΦΤΗΣ ΜΟΚΕΤΑΣ SUMEX ΤΥΠΟΥ KDS

00553	18mm	24



KDS



ΚΟΦΤΗΣ ΜΟΚΕΤΑΣ Η-12ΥΕ

13531	25mm	10



INTER

GET IT NOW



ΚΟΦΤΗΣ ΜΟΚΕΤΑΣ

13748	Μεταλλικός, 18mm	12



KDS

**HOT
SELLER**

**GET IT
NOW**



ΛΕΠΙΔΙ ΜΟΚΕΤΑΣ ΣΕΤ 10 ΤΜΧ.

Barcode	Product Description	Quantity
13535	18mm - 7 εγκοπών (G)	20
15655	18mm - Μαύρα 7 εγκοπών (G)	20
13536	18mm - 14 εγκοπών (G)	20
13532	25mm (H) - 6 εγκοπών	10
13539	18mm - Μαύρα (L) 7 εγκοπών	20
13540	Τραπεζοειδή 5 τμχ.	20



ΛΕΠΙΔΙ ΜΟΚΕΤΑΣ ΤΑΪΒΑΝ ΣΕΤ 10 ΤΜΧ.

Barcode	Product Description	Quantity
03417	18mm	10



INTER



BLISTER

ΨΑΛΙΔΙ ΓΕΝΙΚΗΣ ΧΡΗΣΗΣ

Barcode	Product Description	Quantity
02776	8,5"	12

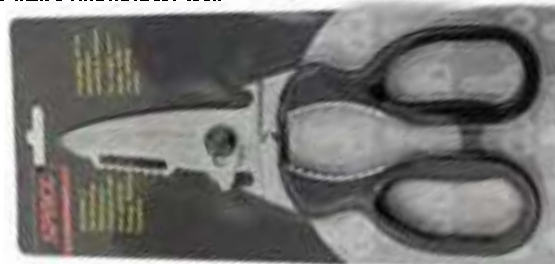

BLISTER

ΨΑΛΙΔΙ ΓΕΝΙΚΗΣ ΧΡΗΣΗΣ ΤΑΪΒΑΝ

Barcode	Product Description	Quantity
04423	20 Εργασιών	12





ΨΑΛΙΔΙ ΛΑΜΑΡΙΝΑΣ

Barcode	Product Description	Quantity
02446	10"	6
03149	12"	6



ΜΥΛΟΣ ΥΠΟΔΗΜΑΤΩΝ

Barcode	Product Description	Quantity
01653	12"	2









GET IT NOW

ΧΩΝΙ ΓΙΓΑΣ

07609	Φ27cm	12

 15634
 15635



PRESSOL

ΧΩΝΙ ΜΕΤΑΛΛΙΚΟ

15634	Φ16cm - code 02342	1
15635	Φ20cm - code 02344	1

NEW ARRIVAL





ΧΩΝΙ ΠΛΑΣΤΙΚΟ ΜΕ ΚΡΙΣΑΡΑ

03693	Φ18cm	6





PRESSOL

ΧΩΝΙ ΠΛΑΣΤΙΚΟ ΜΕ ΣΠΙΡΑΛ 02674

15638		1

NEW ARRIVAL







ΧΩΝΙ ΓΙΓΑΣ ΠΛΑΣΤΙΚΟ ΜΕ ΟΥΡΑ

09408	Φ17,5cm	12





PRESSOL

ΧΩΝΙΑ ΠΛΑΣΤΙΚΑ ΣΕΤ 4 ΤΧΜ 02360

15636		1

NEW ARRIVAL

 01492
 06245
 02598



ΧΩΝΙ ΓΑΛΒΑΝΙΖΕ

01492	Φ16cm	4
06245	Φ22cm	4
02598	Φ25cm	4





PRESSOL

ΧΩΝΙ ΠΛΑΣΤΙΚΟ 02372

15637	Φ16cm	1

NEW ARRIVAL





ΧΩΝΙ ΙΝΟΧ ΓΙΑ ΓΑΛΑ

		
05123	Φ23cm	4





ΜΠΙΤΟΝΙ ΚΑΥΣΙΜΟΥ 21055

		
15641	10 Lt	1



03992



01546



ΡΟΥΞΟΥΝΙ ΠΛΑΣΤΙΚΟ

		
03992	γιά 6 & 9 & 12Lt	10
01546	γιά 10 & 14Lt	10





ΠΟΤΙΣΤΗΡΙ ΓΑΛΒΑΝΙΖΕ

		
01090	12	1





ΧΩΝΙ ΜΟΥΣΤΟΥ ΓΑΛΒΑΝΙΖΕ

		
00619	Φ30cm	2



01948



02182



04161



01105



ΠΟΤΙΣΤΗΡΙ ΠΛΑΣΤΙΚΟ

		
01948	6Lt Μικρό	6
04161	9Lt Μεσαίο	6
02182	12Lt Μεγάλο	6
01105	14Lt Γίγας	4





ΡΟΥΞΟΥΝΙ ΓΑΛΒΑΝΙΖΕ

		
03094		5



PRESSOL



NEW
ARRIVAL

ΜΠΙΤΟΝΙ ΚΑΥΣΙΜΟΥ 21060

Barcode	Volume	Quantity
15642	20 Lt	1



02637



00568



01920



01943



09695



ΜΠΙΤΟΝΙ ΝΕΡΟΥ

Barcode	Volume	Quantity
02637	6Lt	12
01920	10Lt	9
09695	16Lt	8
00568	20Lt	10
01943	28Lt	8



00070



02212



ΜΠΙΤΟΝΙ ΠΕΤΡΕΛΑΙΟΥ

Barcode	Volume	Quantity
00070	12Lt	6
02212	16Lt	5



02296



01864



02458



02295



HOT
SELLER

ΤΡΟΜΠΑ ΛΑΔΙΟΥ

Barcode	Model	Quantity
02296	No1 45cm	5
01864	No2 83cm	5
02458	No3 112cm	5
02295	No4 127cm	5



00181



00180



ΒΡΥΣΗ ΓΑΛΒΑΝΙΖΕ

Barcode	Volume	Quantity
00181	8Lt	1
00180	10Lt	1



- 02173
- 02037
- 02007
- 00528
- 01972
- 03982



ΚΑΡΔΑΡΑ ΙΝΟΧ

02173	80	1
02037	90	1
02007	100	1
00528	110	1
01972	120	1
03982	130	1

- 00396
- 00395
- 00394
- 00393
- 00392
- 02773



ΚΑΡΔΑΡΑ ΓΑΛΒΑΝΙΖΕ

00396	80	1
00395	90	1
00394	100	1
00393	110	1
00392	120	1
02773	130	1



ΚΟΣΚΙΝΟ ΤΡΑΧΑΝΑ ΛΑΜΑΡΙΝΑ

00827	Φ37cm	1



ΚΟΣΚΙΝΟ ΤΡΑΧΑΝΑ ΠΛΕΓΜΑ

00863	Φ32cm	1
00998	Φ36cm	1



ΚΟΣΚΙΝΟ ΣΙΤΑΡΙΟΥ (ΑΡΙΟΛΟΓΙ)

00655	Φ32cm	1
00143	Φ38cm	1

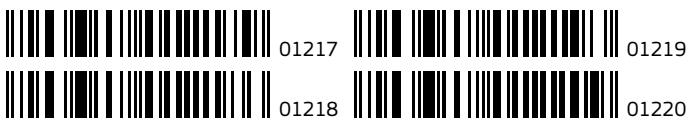

ΣΙΤΑ ΑΛΕΥΡΩΝ

Barcode	Icon	Quantity
01217	(A) Φ32cm	1
01218	(B) Φ28cm	1
01219	(Γ) Φ25cm	1
01220	(Δ) Φ22cm	1



ΚΟΣΚΙΝΟ ΠΛΑΣΤΙΚΟ

Barcode	Icon	Quantity
00630	Φ20cm	6



ΣΕΣΟΥΛΑ ΠΛΑΣΤΙΚΗ

Barcode	Icon	Quantity
09978	Μικρή 25cm - 500ml	10
09979	Μεσαία 30cm - 1000ml	5
09980	Μεγάλη 35cm - 1500ml	5



ΣΕΣΟΥΛΑ ΓΑΛΒΑΝΙΖΕ

Barcode	Icon	Quantity
00791	22cm - 1,3Kg (Φ11cm)	2
02560	25cm - 2,0Kg (Φ12cm)	2
01226	26cm - 2,5Kg (Φ14cm)	2
03735	30cm - 3,0Kg (Φ16cm)	1

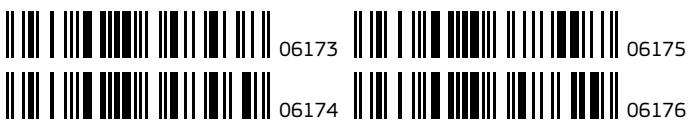

ΣΕΣΟΥΛΑ ΑΛΟΥΜΙΝΙΟΥ

Barcode	Icon	Quantity
06173	58/6	6
06174	80/12	6
06175	98/24	6
06176	120/36	6
06177	128/58	6
07358	130/85	6

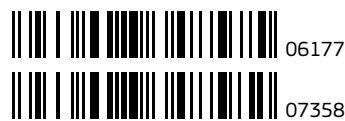



01087 04178
03585



ΠΟΤΙΣΤΡΑ ΠΟΥΛΙΩΝ ΑΥΤΟΜΑΤΗ

01087	Μεγάλη	3
03585	Μικρή	3

ΠΟΤΙΣΤΡΑ ΠΟΥΛΙΩΝ ΜΕ ΦΛΟΤΕΡ

04178		1

01225 01558



ΤΑΪΣΤΡΑ ΑΥΤΟΜΑΤΗ ΠΟΥΛΙΩΝ

01225	Μεγάλη	6
01558	Μικρή	3

00342 04219



ΤΑΪΣΤΡΑ ΠΟΥΛΙΩΝ ΠΛΕΓΜΑ

00342	0,5m	3
04219	1m	3

07965



ΠΙΠΙΛΑ ΚΟΥΝΕΛΙΩΝ

07965		10

04715



ΠΟΤΙΣΤΡΑ ΚΟΥΝΕΛΙΩΝ

04715	Μπουκαλιού	10

00383



ΦΩΛΙΑ ΚΟΥΝΕΛΙΩΝ

00383	45x27x27cm	4

01848 00560



ΤΑΪΣΤΡΑ ΚΟΥΝΕΛΙΩΝ

01848	Μονή	10
00560	Διπλή	10

00336



ΤΑΪΣΤΡΑ ΚΟΥΝΕΛΙΩΝ

00336	Σανού	5
-------	-------	---

01029



ΠΡΟΒΑΤΟΨΑΛΙΔΟ ΕΛΑΤΗΡΙΟΥ

Μεταλλική λαβή

01029	Μεταλλική λαβή	2
-------	----------------	---

08752



ΞΥΣΤΡΙ ΑΛΟΓΩΝ - ΨΑΡΙΩΝ

08752		1
-------	--	---

09320 13262



ΑΠΩΘΗΤΙΚΟ ΠΕΡΙΣΤΕΡΙΩΝ ΙΝΟΧ

09320	1m	25
-------	----	----

ΑΠΩΘΗΤΙΚΟ ΠΕΡΙΣΤΕΡΙΩΝ ΠΛΑΣΤΙΚΟ

13262	0,5m	100
-------	------	-----



03724

03726



03725



ΤΡΑΚΑ ΜΑΥΡΗ ΣΚΥΛΩΝ

Barcode	Icon	Quantity
03724	No0	10
03725	No1	10
03726	No2	10



03727

05455



03728

05456

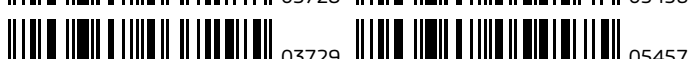

03729

05457

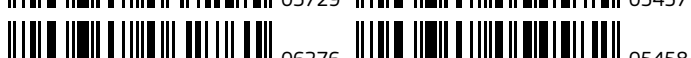

06276

05458

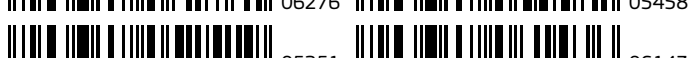

05251

06143

ΤΡΑΚΑ ΜΑΥΡΗ ΠΡΟΒΑΤΩΝ

Barcode	Icon	Quantity
03727	No3	5
03728	No4	5
03729	No5	5
06276	No6	5
05251	No7	5
05455	No8	5
05456	No9	5
05457	No10	5
05458	No20	5
06143	No24	5

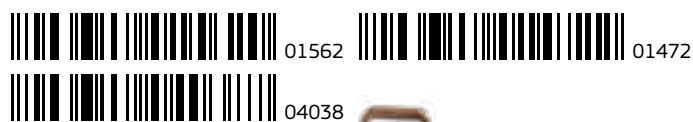

01562

01472



04038



ΤΡΑΚΑ ΚΟΚΚΙΝΗ ΣΚΥΛΩΝ

Barcode	Icon	Quantity
01562	No0	10
04038	No1	10
01472	No2	10



02313

00973



02078

01872



02813

01440

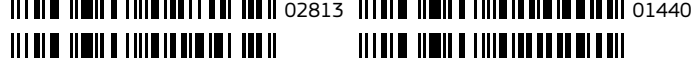

01443

02229

ΤΡΑΚΑ ΚΟΚΚΙΝΗ ΠΡΟΒΑΤΩΝ

Barcode	Icon	Quantity
02313	No4	5
02078	No5	5
02813	No6	5
01443	No7	5
00973	No8	5
01872	No9	5
01440	No10	5
02229	No20	5



ΑΝΤΑΛΛΑΚΤΙΚΟ ΓΛΩΣΣΙΔΙ ΚΟΥΔΟΥΝΙΩΝ

Barcode	Icon	Unit
05250		Kg

	03730		03199
	05306		01964
	05586		00433
	05144		02896
	04947		00969
	03777		02391
	03778		02533
	00896		02612
	00897		00273
	01002		00638
	03130		



ΚΟΥΔΟΥΝΙΑ ΠΡΟΒΑΤΩΝ ΜΑΥΡΟ

03730	No0	10
05306	No1	10
05586	No2	10
05144	No3	10
04947	No4	10
03777	No5	5
03778	No6	5
00896	No7	5
00897	No8	5
01002	No9	5
03130	No10	5
03199	No20	1
01964	No22	1
00433	No24	1
02896	No26	1
00969	No28	1
02391	No30	1
02533	No32	1
02612	No34	1
00273	No38	1
00638	No40	1

	01069		01054
	02459		01205
	00289		02073
	02460		00290
	02461		01204
	02638		00296
	02311		02363
	02462		00267
	02639		01860
	02463		01984
	00569		
	02464		
	02465		
	02642		
	02197		



ΚΟΥΔΟΥΝΙΑ ΠΡΟΒΑΤΩΝ ΚΟΚΚΙΝΟ

01069	No0	10
02459	No1	10
00289	No2	10
02460	No3	10
02461	No4	10
02638	No5	5
02311	No6	5
02462	No7	5
02639	No8	5
02463	No9	5
00569	No10	5
02464	No20	1
02465	No22	1
02642	No24	1
02197	No26	1
01054	No28	1
01205	No30	1
02073	No32	1
00290	No34	1
01204	No36	1
00296	No38	1
02363	No40	1
00267	No45	1
01860	No50	1
01984	No60	1

	03731		01106
	01169		01260
	00980		02576
	01924		02040
	02589		00964
	01305		03062
	02473		00968
	02514		00633



ΚΟΥΔΟΥΝΙ ΠΡΟΒΑΤΩΝ ΜΕ ΑΥΤΙΑ

03731	No0	10
01169	No2	10
00980	No3	10
01924	No4	10
02589	No5	5
01305	No6	5
02473	No7	5
02514	No8	5
01106	No9	5
01260	No10	5
02576	No20	5
02040	No22	1
00964	No24	1
03062	No26	1
00968	No28	1
00633	No30	1

	01436		13927
	13925		13926



ΚΑΜΠΑΝΕΛΑ ΣΚΥΛΩΝ

01436	No1	6
13925	No2	6
13926	No3	6
13927	No4	6



	00419		00422
	00420		00423
	00421		00424



ΚΟΥΔΟΥΝΙ ΣΚΥΛΩΝ

00419	No1	10
00420	No2	10
00421	No3	10
00422	No4	10
00423	No5	10
00424	No6	10



	14884		15487
	14442		06126
	15025		



ΚΑΜΠΑΝΑΚΙ ΟΡΕΙΧΑΛΚΙΝΟ (ΚΥΠΡΙ)

14884	No6	5
14442	No7	5
15025	No8	5
15487	No10	5
06126	Ανταλλακτικό	Kg





ΚΛΙΤΣΑ ΠΛΑΣΤΙΚΗ

00882	Καφέ, Κίτρινη, Μαύρη	20



ΚΑΠΙΣΤΡΑΝΑ ΜΟΣΧΑΡΙΩΝ

00131		6



ΚΑΠΙΣΤΡΑΝΑ ΔΙΠΛΗ

02262	Αλόγων	5
00416	Όνων	6

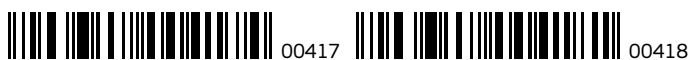

ΚΑΠΙΣΤΡΑΝΑ ΓΙΔΑΣ ΜΟΝΗ

00417	A	5
00418	B	5



ΚΑΠΙΣΤΡΑΝΑ ΓΙΔΑΣ ΔΙΠΛΗ

02327	A	5
02135	B	5





02432 01638

02432

1638

ΛΟΥΡΙΔΑ ΜΕ ΓΑΝΤΖΟ ΓΙΑ ΚΟΥΔΟΥΝΙΑ

Barcode	Icon	Quantity
02432	1 γάντζο	12
01638	2 γάντζους	12

00302 02499

02358

ΛΟΥΡΙΔΑ ΛΥΚΩΝ ΡΑΦΤΗ

Barcode	Icon	Quantity
00302	No2	12
02358	No3	12
02499	No4	12

ΖΕΒΛΑ

Barcode	Icon	Quantity
00397	Πλαστική	10

ΛΟΥΡΙΔΑ ΛΥΚΩΝ ΠΛΑΣΤΙΚΟΠΟΙΗΜΕΝΗ

Barcode	Icon	Quantity
12619	A	12

00717 01202 02333 02335

00716 01570 02334

ΛΟΥΡΙΔΑ ΛΥΚΩΝ

Barcode	Icon	Quantity
00717	B	12
00716	A	12

ΛΟΥΡΙΔΑ ΒΑΚΕΤΑ ΛΥΚΩΝ

Barcode	Icon	Quantity
01202	Μεσαία	12
01570	Μεγάλη	12

ΛΟΥΡΙΔΑ ΡΑΦΤΗ ΜΕ ΚΑΡΦΙΑ

Barcode	Icon	Quantity
02333	No2	12
02334	No3	12
02335	No4	12

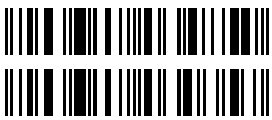

03485

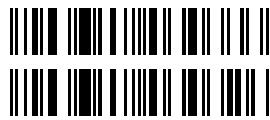

03033

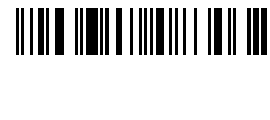

08303



ΙΜΑΝΤΑΣ ΣΚΥΛΩΝ

Barcode	Icon	Quantity
03485	No1	12
03035	No2	12
03033	No3	12
03032	No4	12
08303	No5	10



02098



00715



ΛΟΥΡΙΔΑ ΜΠΕΜΠΕ

Barcode	Icon	Quantity
02098		12

ΛΟΥΡΙΔΑ ΣΚΥΛΩΝ

Barcode	Icon	Quantity
00715		12



14813



14816



14814



14817



14815

INTER



02349



03029



00185



01807



02279

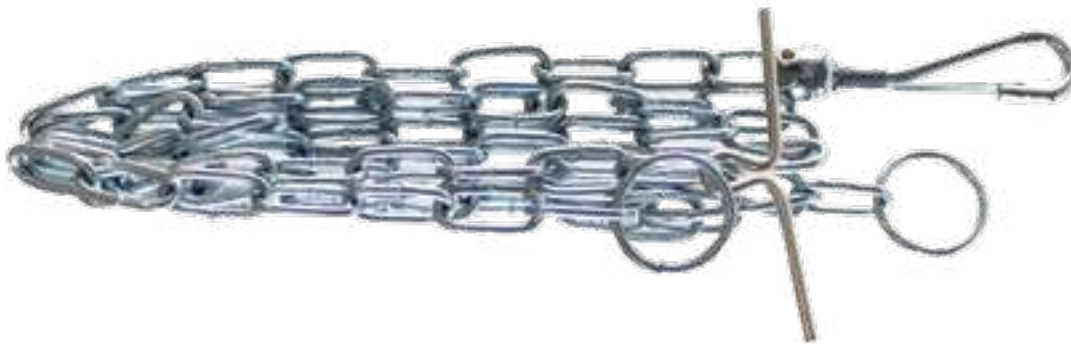

ΑΛΥΣΙΔΑ ΣΚΥΛΩΝ ΓΑΛΒΑΝΙΖΕ 2m

Barcode	Icon	Quantity
14813	2,5mm	10
14814	3,0mm	10
14815	3,5mm	10
14816	4,0mm	10
14817	5,0mm	10

ΑΛΥΣΙΔΑ ΣΚΥΛΩΝ ΓΑΛΒΑΝΙΖΕ 3m

Barcode	Icon	Quantity
02349	2,5mm	12
00185	3,0mm	12
02279	3,5mm	12
03029	4,0mm	12
01807	5,0mm	10



ΠΑΓΙΔΑ ΞΥΛΙΝΗ ΠΟΝΤΙΚΩΝ ΜΕ ΚΟΛΛΑ

15330	17,5 x 13,5cm (σετ 2 τμχ.)	24
-------	----------------------------	----



ΔΟΛΩΜΑ ΤΡΟΚΤΙΚΩΝ VELTO PASTA EXTREME

15331	σε πάστα 150gr	27
-------	----------------	----



ΠΑΣΑΛΑΚΙ ΖΩΩΝ ΜΕ ΧΑΛΚΑ

09159	30cm	12
09160	40cm	9
09161	50cm	8



ΦΑΚΑ

02083	Μικρή	12
02063	Μεγάλη	12



ΦΑΚΑ-ΚΛΟΥΒΑ ΣΙΔΕΡΕΝΙΑ

02164	23x14cm (Μεσαία)	12
01725	32x14cm (Γίγας)	12

ΦΑΚΑ-ΚΛΟΥΒΑ ΞΥΛΙΝΗ

01724	23x9cm (Μικρή)	15
-------	----------------	----



ΠΟΝΤΙΚΟΚΟΛΛΑ

06569	Με παγίδα χάρτινη Σετ 2 τμχ.	25
09199	135gr RATCOLL	25

ΣΤΡΙΦΤΑΡΙΑ - ΜΟΤΕΡ ΣΟΥΒΛΑΣ

	12026		12029
	12027		11858
	12028		11859



ΣΤΡΙΦΤΑΡΙΑ ΕΓΧΩΡΙΟ

12026	No40	100
12027	No50	100
12028	No60	100
12029	No70	100
11858	No80	50
11859	No100	50



	11351		11354
	11352		11355
	11353		11356



ΣΤΡΙΦΤΑΡΙΑ ΙΝΟΧ

11351	No5	10
11352	No6	10
11353	No8	10
11354	No10	10
11355	No13	1
11356	No16	1

	03825		03827
	03826		03828



ΣΤΡΙΦΤΑΡΙΑ ΧΡΩΜΙΟΥ ΒΑΡΕΩΣ ΤΥΠΟΥ

03825	1/2"	100
03826	5/8"	100
03827	3/4"	50
03828	1"	50



	01341		01344
	01342		01345
	01343		



ΣΤΡΙΦΤΑΡΙΑ

01341	No40	100
01342	No50	50
01343	No60	50
01344	No70	25
01345	No80	25



ΜΟΤΕΡ ΑΡΝΙΟΥ SPECIAL 20W

10332	20 Στροφών/min	4



ΜΟΤΕΡ ΑΡΝΙΟΥ SPECIAL EXTRA 50W

14938	20 Στροφών/min	4

NEW
ARRIVAL





ΜΟΤΕΡ 2 ΤΑΧΥΤΗΤΩΝ M3

		
02039	12V & 230V	6





ΜΟΤΕΡ ΑΡΝΙΟΥ ΑΕΡΟ ΑΕΡΟΨΥΚΤΟ MA1

		
07086	18 Στροφών/min	6







ΜΟΤΕΡ JET ΕΠΑΓΓΕΛΜΑΤΙΚΟ M1

		
05147	20 Στροφών/min	6





ΜΟΤΕΡ BOSS ΒΑΡΕΩΣ ΤΥΠΟΥ ΑΕΡΟΨΥΚΤΟ M2

		
09082	135Watt	4





ΜΟΤΕΡ ΓΙΑ ΑΤΕΡΜΟΝΑ M100

		
07751	21 Στροφών/min	1





ΜΟΤΕΡ ΜΕ ΦΤΕΡΩΤΗ ΓΙΑ ΑΤΕΡΜΟΝΑ M5

		
05899	18 Στροφών/min	1



ΜΟΤΕΡ ΚΟΚΟΡΕΤΣΙΟΥ ΜΕ ΜΕΤΑΣΧΗΜΑΤΙΣΤΗ ΤΑΪΒΑΝ

06431	2 ταχυτήτων	10



ΜΟΤΕΡ ΚΟΚΟΡΕΤΣΙΟΥ ΜΠΑΤΑΡΙΑΣ

02167	1.5V	10



02890



03959



04616



03960



03148



08226



10059



01557



02131



ΤΣΙΓΓΕΛΙΑ ΜΟΝΑ ΙΝΟΧ

02890	100 x Φ5mm	10
03959	120 x Φ5mm	10
04616	140 x Φ5mm	10
03960	160 x Φ6mm	10
03148	180 x Φ6mm	10

ΤΣΙΓΓΕΛΙΑ ΜΟΝΑ ΝΙΚΕΛΕ

08226	170 x Φ6mm	10
10059	200 x Φ7mm	10

ΤΣΙΓΓΕΛΙΑ ΔΙΠΛΑ

01557	Μικρό (13,5cm)	5
02131	Μεγάλο (18,5cm)	5

05940
08424





08424



ΓΡΑΝΑΖΙ ΣΟΥΒΛΑΣ ΓΙΑ ΑΤΕΡΜΟΝΑ ΨΗΣΤΑΡΙΑΣ

Barcode	Icon	Unit
05940	σκέτο	1
08424	με χερούλι	1

10470
10471





ΑΤΕΡΜΟΝΑΣ ΨΗΣΤΑΡΙΑΣ ΔΙΠΛΟΣ ΧΩΡΙΣ ΣΟΥΒΛΕΣ

Barcode	Icon	Unit
10470	Σετ 3 Θέσεων	1
10471	Σετ 5 Θέσεων	1

02123
05932



06217
02163





ΑΤΕΡΜΟΝΑΣ ΨΗΣΤΑΡΙΑΣ ΣΕΤ 5 ΘΕΣΕΩΝ

Barcode	Icon	Unit
02123	με σουβλες (1αρνή-1κοκορέτσι)	1
05932	χωρίς σουβλες	1

ΑΤΕΡΜΟΝΑΣ ΨΗΣΤΑΡΙΑΣ ΣΕΤ 3 ΘΕΣΕΩΝ

Barcode	Icon	Unit
06217	με σουβλες (1αρνή-1κοκορέτσι)	1
02163	χωρίς σουβλες	1



06606

09009

06087

09008



ΣΟΥΒΛΑ ΚΟΚΟΡΕΤΣΙΟΥ ΜΕ ΓΡΑΝΑΖΙ ΓΙΑ ΑΤΕΡΜΟΝΑ

Barcode	Icon	Unit
06606	Φ12mm 1,95m	12
09009	10x10mm 1,6m	10

ΣΟΥΒΛΑ ΑΡΝΙΟΥ ΜΕ ΓΡΑΝΑΖΙ ΓΙΑ ΑΤΕΡΜΟΝΑ

Barcode	Icon	Unit
06087	Φ16mm 1,95m	12
09008	14x14mm 1,6m	10

01775 05768 04716 15377

ΣΟΥΒΛΑ ΚΟΚΟΡΕΤΣΙΟΥ ΓΙΑ ΜΟΤΕΡ ΤΕΤΡΑΓΩΝΗ

01775	1,70m (8x8mm)	10
-------	---------------	----

ΣΟΥΒΛΑ ΑΡΝΙΟΥ ΓΙΑ ΜΟΤΕΡ (Φ16mm)

05768	Χρωμίου 1,70m	6
04716	Inox 1,80m	12

ΣΟΥΒΛΑ ΑΡΝΙΟΥ ΓΙΑ ΜΟΤΕΡ (Φ19mm)

15377	Χρωμίου (1,90m)	8
-------	-----------------	---

GET IT NOW
NEW ARRIVAL

02510 02149 06644

ΣΟΥΒΛΑ ΚΟΚΟΡΕΤΣΙ ΜΕ ΞΥΛΙΝΟ ΧΕΡΙ ΤΕΤΡΑΓΩΝΗ

02510	1,00m (6x6mm)	10
02149	1,20m (6x6mm)	10
06644	1,80m (8x8mm)	10

01973 10055 05145 09089 00573

ΔΙΧΑΛΕΣ

01973	Αρνιού Inox Φ20mm	10
09089	Αρνιού Κασσιτερωμένη Φ21mm	10
10055	Κοκορετσαίου Inox Φ14mm	10
00573	Κοκορετσαίου Νίκελ Φ16mm	10
05145	Κοτόπουλου διπλή Inox 16x16mm	10

GET IT NOW

05157 05479

ΣΦΙΓΚΤΗΡΕΣ ΑΡΝΙΩΝ

05157	Μεγάλος κασιτερωμένος	20
05479	Μικρός κασιτερωμένος	25

HOT SELLER
GET IT NOW

01552 01553

ΤΣΙΜΠΙΔΕΣ ΚΑΡΒΟΥΝΩΝ

01552	Μεσαία 50cm	10
01553	Μεγάλη 65cm	10



04159

Πτυσσόμενο

20

ΤΡΙΠΟΔΟ ΣΟΥΒΛΑΣ



03659

04041

00635

ΠΥΡΟΣΤΙΕΣ

03659	25cm (Μικρή) Νο1	5
00635	30cm (Μεσαία) Νο2	5
04041	35cm (Μεγάλη) Νο3	5



02148

12x12mm (75cm)

10

ΠΑΣΑΛΟΙ ΑΡΝΙΩΝ ΚΑΡΦΩΤΟΙ



09109

09111

09110

ΣΧΑΡΑ ΨΗΣΤΑΡΙΑΣ ΜΕ ΠΟΔΙΑ (ΠΛΑΙΣΙΟ ΓΩΝΙΑ)

09109	60x40cm	2
09110	80x35cm	2
09111	100x35cm	1



00428

00879

02115

06705

ΣΧΑΡΑ ΨΗΣΤΑΡΙΑΣ ΜΕ ΠΟΔΙΑ (ΠΛΑΙΣΙΟ ΣΥΡΜΑ)

00428	40x40cm	2
02115	60x40cm	1
00879	80x40cm	1
06705	100x40cm	1

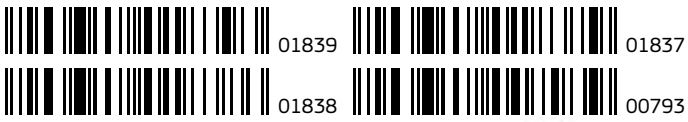

ΨΗΣΤΑΡΙΑ ΛΥΟΜΕΝΗ

Barcode	Icon	Icon
01839	(Γ) Μικρή 47x30cm	6
01838	(B) Μεσαία 56x30cm	6
01837	(A) Μεγάλη 67x30cm	3
00793	(AA) Γίγας 75x40cm	3

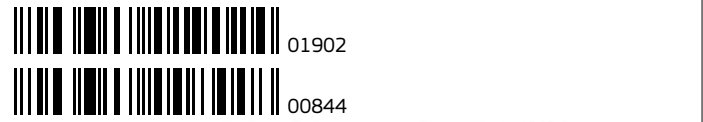

ΨΗΣΤΑΡΙΑ ΛΥΟΜΕΝΗ ΜΕ ΡΟΔΕΣ

Barcode	Icon	Icon
01902	No3 48x33cm	1
00844	No5 75x40cm	1



ΨΗΣΤΑΡΙΑ ΑΡΝΙΟΥ 1,45Μ ΜΕ ΠΛΑΤΗ ΚΑΠΑΚΙ ΓΑΛΒΑΝΙΖΕ

Barcode	Icon	Icon
08263	με σάρα, χωρίς σούβλες	1



ΨΗΣΤΑΡΙΑ ΛΥΟΜΕΝΗ ΜΕ ΠΛΑΤΗ ΚΑΠΑΚΙ

Barcode	Icon	Icon
14127	No3 67x30cm	3
14128	No5 75x40cm	3



ΨΗΣΤΑΡΙΑ ΑΡΝΙΟΥ 1,45m ΓΑΛΒΑΝΙΖΕ ΧΩΡΙΣ ΣΟΥΒΛΕΣ



10075



Χωρίς πλάτη με σάρα



1



ΨΗΣΤΑΡΙΑ ΑΡΝΙΟΥ 1,45m ΓΑΛΒΑΝΙΖΕ ΔΙΠΛΗ ΧΩΡΙΣ ΣΟΥΒΛΕΣ



02355



Χωρίς πλάτη με 2 σάρες



1

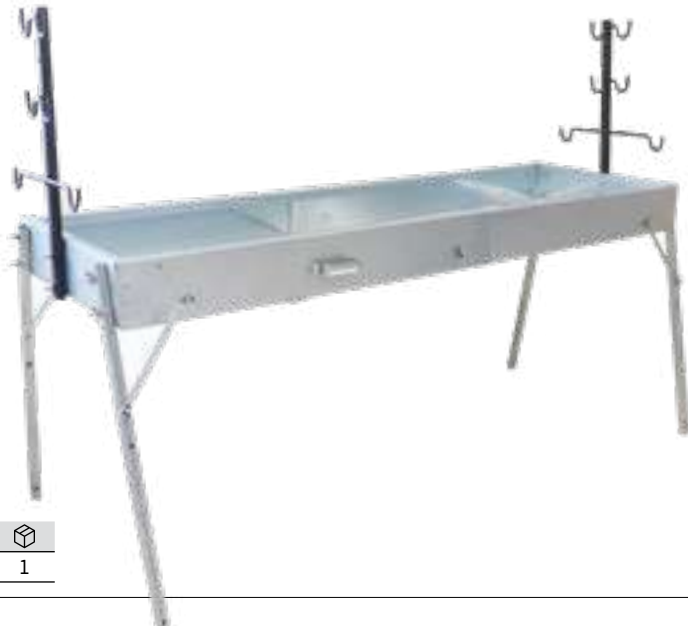

ΨΗΣΤΑΡΙΑ ΑΡΝΙΟΥ 1,50m ΓΑΛΒΑΝΙΖΕ ΣΥΡΤΑΡΩΤΗ ΧΩΡΙΣ ΣΟΥΒΛΕΣ



14129



Χωρίς πλάτη και σάρα



1



ΣΧΑΡΑ ΛΥΟΜΕΝΗΣ ΨΗΣΤΑΡΙΑΣ ΜΕ ΠΛΑΤΗ

Barcode	Product Name	Quantity
02133	No3 (68x32cm)	5
02132	No4 (76x32cm)	5
00636	No5 (76x43cm)	5

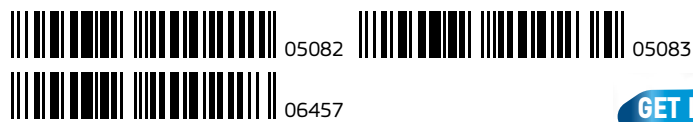

GET IT NOW



ΣΧΑΡΑ ΑΝΤΙΚΟΛΛΗΤΙΚΗ ΧΩΡΙΣ ΠΟΔΙΑ

Barcode	Product Name	Quantity
05082	No4 (35x30cm)	6
06457	No5 (40x35cm)	6
05083	No6 (45x40cm)	6



GET IT NOW



ΣΧΑΡΑ ΑΝΤΙΚΟΛΛΗΤΙΚΗ ΜΕ ΠΟΔΙΑ ΤΑΪΒΑΝ

Barcode	Product Name	Quantity
03600	No4 (35x30cm)	4
05084	No5 (40x35cm)	6
05085	No6 (45x40cm)	6



NEW ARRIVAL



ΣΧΑΡΑ ΨΑΡΙΟΥ ΚΑΡΕ ΜΕΓΑΛΗ

Barcode	Product Name	Quantity
14922	χωρίς πόδια (43x13,5cm)	10



ΣΧΑΡΑ ΨΑΡΙΟΥ ΚΑΡΕ 26x14cm

03733	No1 χωρίς πόδια	10
04612	No1 με πόδια	10



ΣΧΑΡΑ ΝΙΚΕΛΕ ΑΤΟΜΙΚΗ 27x20cm

06628	No3 χωρίς πόδια	10
08504	No3 με πόδια	16



GET IT NOW



ΣΧΑΡΑ ΙΝΟΧ ΜΕ ΠΟΔΙΑ

04312	No5 (40x35cm)	16



GET IT NOW



ΣΧΑΡΑ ΙΝΟΧ ΧΩΡΙΣ ΠΟΔΙΑ

05090	No5 (40x35cm)	10



GET IT NOW



ΣΧΑΡΑ ΚΑΡΕ ΧΩΡΙΣ ΠΟΔΙΑ

Barcode	Product Name	Quantity
02383	No4 (33x29cm)	10
02382	No5 (40x33cm)	10
03443	No6 (46x37cm)	10



GET IT NOW



ΣΧΑΡΑ ΚΑΡΕ ΜΕ ΠΟΔΙΑ

Barcode	Product Name	Quantity
00783	No4 (33x29cm)	10
02129	No5 (40x33cm)	10
03444	No6 (46x38cm)	10



NEW ARRIVAL



ΣΧΑΡΑ ΑΠΛΗ ΝΕΟΥ ΤΥΠΟΥ ΜΕ ΠΟΔΙΑ

Barcode	Product Name	Quantity
14841	No4 (33x29cm)	10



GET IT NOW



ΣΧΑΡΑ ΑΠΛΗ ΝΕΟΥ ΤΥΠΟΥ 40x33cm

Barcode	Product Name	Quantity
03445	No5 χωρίς πόδια	10
03446	No5 με πόδια	10



01939 12609



01938 05785



01937 14998



NEW
ARRIVAL

GET IT NOW



ΣΧΑΡΑ ΑΠΛΗ ΧΩΡΙΣ ΠΟΔΙΑ

Barcode	Product Name	Quantity
01939	No4 (33x29cm)	10
01938	No5 (40x32cm)	20
01937	No6 (46x37cm)	20
12609	No6 (46x37cm) Λαβή μικρή πλευρά	10
05785	No7 (50x30cm)	10
14998	No5 (40x34cm) Λαβή μικρή πλευρά	10



02811



02812



03213



GET IT NOW



ΣΧΑΡΑ ΑΠΛΗ ΜΕ ΠΟΔΙΑ

Barcode	Product Name	Quantity
02811	No4 (33x28cm)	10
02812	No5 (40x33cm)	10
03213	No6 (46x37cm)	10



05114



05115



05116



GET IT NOW



ΣΧΑΡΑ ΝΙΚΕΛ ΜΕ ΠΟΔΙΑ

Barcode	Product Name	Quantity
05114	No4 (35x31cm)	6
05115	No5 (40x34cm)	6
05116	No6 (45x40cm)	6



05086



05087



05088



GET IT NOW



ΣΧΑΡΑ ΝΙΚΕΛ ΧΩΡΙΣ ΠΟΔΙΑ

Barcode	Product Name	Quantity
05086	No4 (35x30cm)	6
05087	No5 (40x34cm)	6
05088	No6 (45x40cm)	6

ΠΑΡΕΛΚΟΜΕΝΑ ΤΖΑΚΟΣΜΠΑΣ





ΦΤΥΑΡΑΚΙ ΓΙΑ ΣΕΤ ΤΖΑΚΙΟΥ ΤΑΪΒΑΝ

06159	560mm	5



04686



00697



05745



ΦΤΥΑΡΑΚΙΑ ΤΖΑΚΙΟΥ

04686	No1 Μικρό	5
00697	No2 Μεγάλο	5
05745	No3 Γίγας	5





ΓΑΝΤΖΟΣ ΤΖΑΚΙΟΥ ΓΙΑ ΞΥΛΑ



03601	560mm	5





ΤΣΙΜΠΙΔΑ ΓΙΑ ΞΥΛΑ

04962	670mm	6

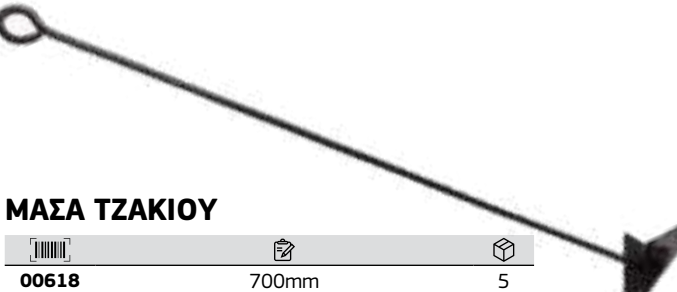



ΜΑΣΑ ΤΖΑΚΙΟΥ

00618	700mm	5



INTER



ΦΑΡΑΣΙ ΜΕΤΑΛΛΙΚΟ ΣΤΕΝΟ ΣΤΟΦΑΣ

01371	470 x 190mm	10



02331



10645



08954





ΓΩΝΙΑ ΕΜΑΓΙΕ

02331	Φ120mm Καφέ	20
10645	Φ120mm Μαύρο	20
08954	Φ150mm Μαύρο	15



HOT SELLER



08585



09019

ΓΩΝΙΑ ΓΑΛΒΑΝΙΖΕ

08585	Φ120mm	24
09019	Φ180mm	1



03169 08952
03168
02361
10648
10647
10646
08953

HOT SELLER
GET IT NOW



ΣΩΛΗΝΑΣ ΕΜΑΓΙΕ

Barcode	Icon	Box
03169	Φ120mm Καφέ 30cm	24
03168	Φ120mm Καφέ 60cm	12
02361	Φ120mm Καφέ 90cm	12
10648	Φ120mm Μαύρος 30cm	24
10647	Φ120mm Μαύρος 60cm	12
10646	Φ120mm Μαύρος 90cm	12
08953	Φ150mm Μαύρος 50cm	12
08952	Φ150mm Μαύρος 90cm	12



08510
08958



ΣΩΛΗΝΑΣ ΓΑΛΒΑΝΙΖΕ

Barcode	Icon	Box
08510	Φ120mm x 90cm	10
08958	Φ150mm x 100cm	7



03171 09622
10644



ΤΑΦ ΕΜΑΓΙΕ

Barcode	Icon	Box
03171	Φ120mm Καφέ	24
10644	Φ120mm Μαύρο	24
09622	Φ150mm Μαύρο	18



08492
08956
04225
09776



ΤΑΦ ΓΑΛΒΑΝΙΖΕ

Barcode	Icon	Box
08492	Φ120mm	20
08956	Φ150mm	4
04225	Σωληνακία Φ120mm	10
09776	Σωληνακία Φ150mm	6



03170 09621
10643



HOT SELLER

ΗΤΑ ΕΜΑΓΙΕ

Barcode	Icon	Box
03170	Φ120mm Καφέ	9
10643	Φ120mm Μαύρο	9
09621	Φ150mm Μαύρο	9



08491 08955



ΗΤΑ ΓΑΛΒΑΝΙΖΕ

Barcode	Icon	Box
08491	Φ120mm	10
08955	Φ150mm	6

13354 08345
13601
13527



ΣΥΣΤΟΛΙΚΟ

Barcode	Icon	Volume
13354	Φ130-120mm Καφέ	1
13601	Φ130-120mm Μαύρο	1
13527	Φ150-120mm Γαλβανιζέ	1

ΤΑΠΑ ΣΩΛΗΝΩΝ ΝΙΚΕΛΕ

Barcode	Icon	Volume
08345	Φ120mm	10



12481
12716
12482



ΚΑΖΟ ΕΜΑΓΙΕ

Barcode	Icon	Volume
12481	Φ120mm Καφέ	1
12716	Φ120mm Μαύρο	1
12482	Φ150mm Μαύρο	1



03172 02360
08493
08965



ΡΟΖΕΤΑ ΣΩΛΗΝΩΝ

Barcode	Icon	Volume
03172	Φ120mm Χρυσή	10
08493	Φ120mm Καφέ	10
08965	Φ150mm Μαύρη	10

ΔΑΧΤΥΛΙΔΙ ΣΩΛΗΝΩΝ

Barcode	Icon	Volume
02360	Φ120mm	20

GET IT NOW



12483



ΚΑΠΕΛΟ ΙΝΟΧ ΠΕΡΙΣΤΡΕΦΟΜΕΝΟ

Barcode	Icon	Volume
12483	Φ120mm	1



01769



ΣΤΕΓΝΩΤΗΡΙΟ ΡΟΥΧΩΝ

Barcode	Icon	Volume
01769	Γαλβανιζέ	12

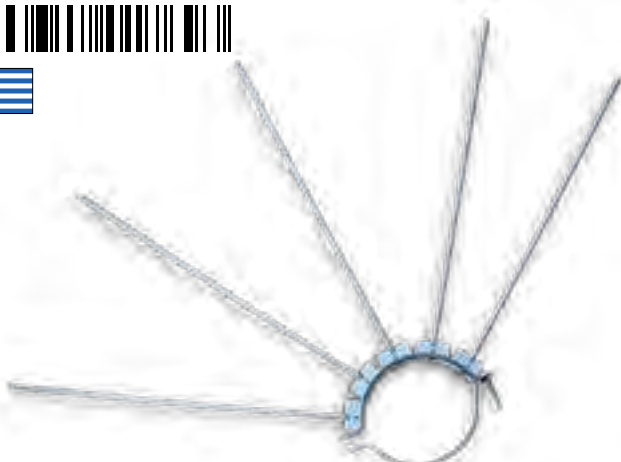

04591
04590



ΠΡΟΕΚΤΑΣΗ ΒΟΥΡΤΣΑΣ ΚΑΜΙΝΑΔΑΣ

Barcode	Icon	Volume
04591	1m	5
04590	2m	10

HOT SELLER
GET IT NOW





08931 07590

08509 04586

13750 04587



GET IT NOW

ΒΟΥΡΤΣΑ ΚΑΜΙΝΑΔΑΣ ΣΤΡΟΓΓΥΛΗ ΙΤΑΛΙΑΣ

Barcode	Icon	Box
08931	Φ120mm	6
08509	Φ150mm	6
13750	Φ180mm	6
07590	Φ200mm	6
04586	Φ250mm	6
04587	Φ300mm	6

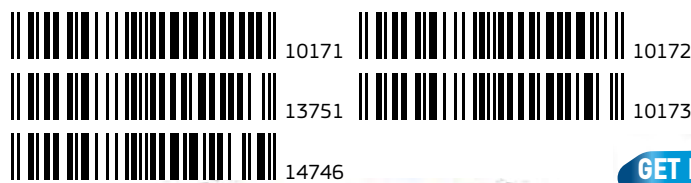

10171 10172

13751 10173

14746



10173



GET IT NOW

ΒΟΥΡΤΣΑ ΚΑΜΙΝΑΔΑΣ ΝΑΥΛΟΝ ΣΤΡΟΓΓΥΛΗ

Barcode	Icon	Box
10171	Φ80mm για Πέλλετ	2
13751	Φ120mm	2
14746	Φ150mm	2
10172	Φ200mm	2
10173	Φ250	2

10171



04588 04589

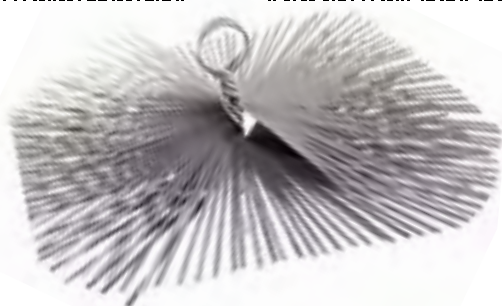

GET IT NOW

ΒΟΥΡΤΣΑ ΚΑΜΙΝΑΔΑΣ ΤΕΤΡΑΓΩΝΗ

Barcode	Icon	Box
04588	250x250mm	6
04589	300x300mm	10



ΚΑΣΤΑΝΙΕΡΑ

Barcode	Icon	Box
05743	19x19mm	5



02374 02386



04040

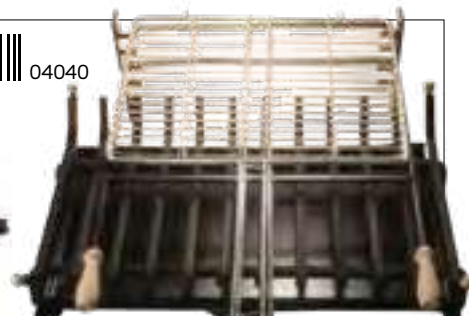

ΣΧΑΡΑ ΤΖΑΚΙΟΥ

Barcode	Icon	Box
02374	60/40 x 40 x 15cm	1
02386	60 x 43 x 17cm	1

ΣΧΑΡΑ ΤΖΑΚΙΟΥ ΜΕ ΥΠΟΔΟΧΗ ΣΧΑΡΑΣ

Η σχάρα δεν συμπεριλαμβάνεται

Barcode	Icon	Box
04040	60 x 36 x 17cm	1

ΣΕΤ ΤΖΑΚΙΟΥ - ΣΙΤΕΣ

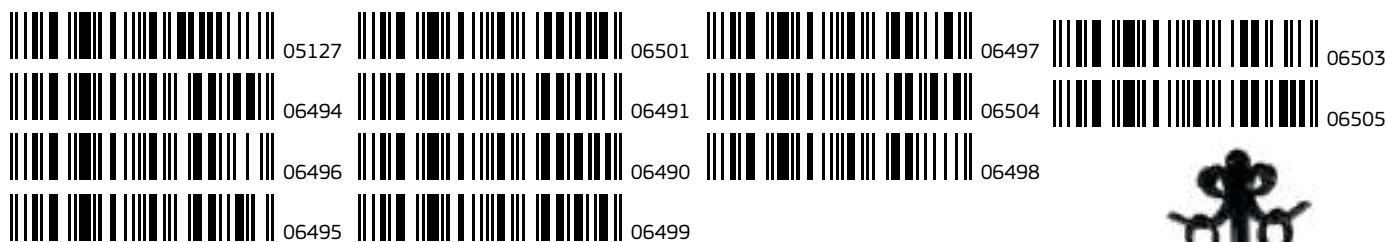

ΣΕΤ ΤΖΑΚΙΟΥ ΚΙΤΡΙΝΟ ΤΑΪΒΑΝ

Barcode	Icon	Quantity
05127	5136 PB	4

ΣΕΤ ΤΖΑΚΙΟΥ

Barcode	Icon	Quantity
06494	Γκρι	1
06496	Μαύρο	1
06495	Σκουριά	1
06501	Χρυσό	1

ΣΕΤ ΤΖΑΚΙΟΥ ΚΟΥΒΑΔΑΚΙ

Barcode	Icon	Quantity
06491	Σκουριά	1
06490	Χαλκό	1

ΣΕΤ ΤΖΑΚΙΟΥ ΚΑΡΑΒΟΛΑΚΙ

Barcode	Icon	Quantity
06499	Γκρι	1
06497	Μαύρο	1
06504	Νικελ	1
06498	Σκουριά	1
06503	Χαλκός	1
06505	Χρυσό	1



ΣΙΤΑ ΜΟΝΟΦΥΛΛΗ 606

Barcode	Icon	Quantity
05657	Σιδερένια	1

ΣΙΤΑ ΔΙΦΥΛΛΗ 606

Barcode	Icon	Quantity
05743	Σιδερένια	1



ΣΙΤΑ 3ΦΥΛΛΗ ΚΑΜΠΥΛΗ

06483	Μαύρη	1



06484



06476



06480



06468



ΣΙΤΑ 3ΦΥΛΛΗ ΙΣΙΑ

06484	Γκρι	1
06480	Μαύρη	1
06476	Νίκελ	1
06468	Σκουριά	1



03680



06564



ΣΙΤΑ 3ΦΥΛΛΗ ΜΑΥΡΗ ΣΙΔΕΡΕΝΙΑ

03680	1.10m	1
06564	1.20m	1



ΣΙΤΑ 3ΦΥΛΛΗ ΑΝΤΙΚΕ-ΑΣΗΜΙ ΤΑΪΒΑΝ

07255	FS-10276C/BAS	4





ΣΙΤΑ 3ΦΥΛΛΗ ΑΝΤΙΚΕ-ΟΡΕΙΧΑΛΚΙΝΗ ΤΑΪΒΑΝ

07256	FS-10276C/BAB	4



07252



07254

07252



07254

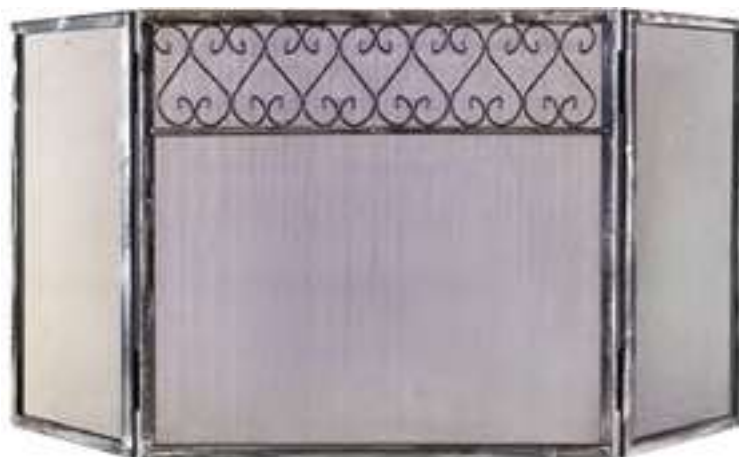

ΣΙΤΑ 3ΦΥΛΛΗ ΑΝΤΙΚΕ-ΑΣΗΜΙ ΤΑΪΒΑΝ

07252	FS-10276/BAS	4
07254	FS-10276B/BAS	4

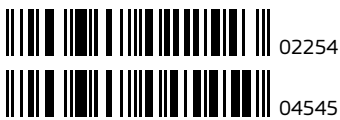

ΣΥΡΤΑΡΟΘΗΚΕΣ ΣΕΙΡΑ Α/Β

Barcode	Icon	Icon
02254	8 συρτ. 20x37,5x15,5cm (ΜxΠxΥ)	1
04545	13 συρτ. 20x37,5x21,7cm (ΜxΠxΥ)	1



ΣΥΡΤΑΡΟΘΗΚΗ ΠΕΡΙΣΤΡΕΦΟΜΕΝΗ

Barcode	Icon	Icon
00358	55x55x180cm (ΜxΠxΥ)	1



ΚΟΥΤΙΑ ΣΥΡΤΑΡΩΤΑ ΜΠΛΕ ΠΛΑΣΤΙΚΑ

Barcode	Icon	Icon
09801	E1(A) 16x10,5x8cm	10
09433	E2(A) 23x14,5x13cm	28
07316	E3(A) 28x18x16,5cm	15
09434	E4(A) 35x20x20cm	10
09435	E5(A) 50x32,5x19cm	5



ΚΟΥΤΙΑ ΣΥΡΤΑΡΩΤΑ ΚΟΚΚΙΝΑ ΠΛΑΣΤΙΚΑ

Barcode	Icon	Icon
04662	K/2 (24x17x11,8)cm	10
01881	K/303 (30x20x17)cm	10
07318	K/304 (24x31x17)cm	10
04563	K/305 (40x31x17)cm	10



ΚΟΥΤΙΑ ΣΥΡΤΑΡΩΤΑ ΜΠΛΕ ΠΛΑΣΤΙΚΑ

Barcode	Icon	Icon
07317	K/303 (30x20x17)cm	10
04499	K/304 (24x31x17)cm	10
07319	K/305 (40x31x17)cm	10





ΣΥΡΤΑΡΙ ΣΥΡΤΑΡΟΘΗΚΗΣ ΔΙΑΦΑΝΟ ΣΕΙΡΑ Α

04954	19,6x7x5,4cm (ΜxΠxΥ)	1

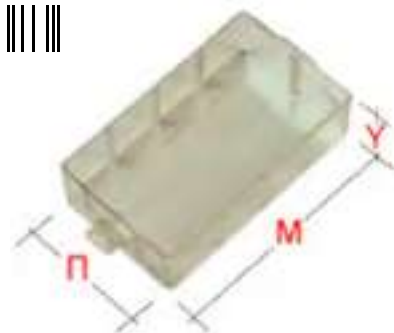

ΣΥΡΤΑΡΙ ΣΥΡΤΑΡΟΘΗΚΗΣ ΔΙΑΦΑΝΟ ΣΕΙΡΑ Β

05138	19,6x11,5x5,4cm (ΜxΠxΥ)	1



ΣΥΡΤΑΡΙ ΣΥΡΤΑΡΟΘΗΚΗΣ ΔΙΑΦΑΝΟ ΣΕΙΡΑ Γ

04277	24,7 x15,2x7cm (ΜxΠxΥ)	1



ΣΥΡΤΑΡΙ ΣΥΡΤΑΡΟΘΗΚΗΣ ΔΙΑΦΑΝΟ ΣΕΙΡΑ Η

07072	40x31x7cm (ΜxΠxΥ)	1



ΔΙΑΧΩΡΙΣΤΙΚΑ ΓΙΑ ΚΟΥΤΙΑ ΦΟΡΙΑΜΩΝ

04473	(K/304)	1
04731	(K/305) ΚΑΘΕΤΟ	1
01961	(K/305) ΟΡΙΖΟΝΤΙΟ	1
05481	Σειρά Κ ΟΡΙΖΟΝΤΙΟ	1



ΔΙΑΧΩΡΙΣΤΙΚΑ ΓΙΑ ΣΥΡΤΑΡΟΘΗΚΕΣ

01683	Σειρά Α ΟΡΙΖΟΝΤΙΟ	1
01078	Σειρά Β ΟΡΙΖΟΝΤΙΟ	1
01009	Σειρά Γ ΚΑΘΕΤΟ	1
04272	Σειρά Γ ΟΡΙΖΟΝΤΙΟ	1
04970	Σειρά Η ΚΑΘΕΤΟ	1
04971	Σειρά Η ΟΡΙΖΟΝΤΙΟ	1

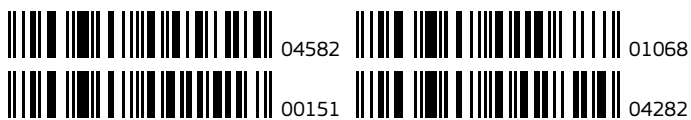

ΣΥΡΤΑΡΟΘΗΚΕΣ ΣΕΙΡΑ Α

Barcode	Product Name	Quantity
04582	A/25(25συρ.) 20x37,5x35cm (ΜxΠxΥ)	1
00151	A/40(40συρ.) 20x37,5x55cm (ΜxΠxΥ)	1
01068	A/60(60συρ.) 20x37,5x82cm (ΜxΠxΥ)	1
04282	A/120(120συρ.) 20x37,5x162cm (ΜxΠxΥ)	1



ΣΥΡΤΑΡΟΘΗΚΕΣ ΣΕΙΡΑ Β

Barcode	Product Name	Quantity
04283	B/15(15συρ.) 20x37,5x35cm (ΜxΠxΥ)	1
04276	B/16(16συρ.) 20x49x28,5cm (ΜxΠxΥ)	1
01766	B/24(24συρ.) 20x37,5x55cm (ΜxΠxΥ)	1
04284	B/36(36συρ.) 20x37,5x82cm (ΜxΠxΥ)	1
04493	B/72(72συρ.) 20x37,5x162cm (ΜxΠxΥ)	1

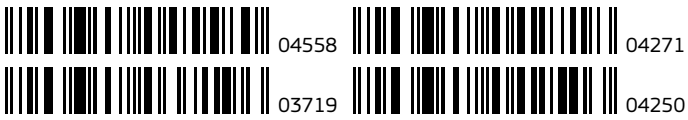

ΣΥΡΤΑΡΟΘΗΚΕΣ ΣΕΙΡΑ Γ

Barcode	Icon	Icon
04558	Γ/9(9συσ.) 27x49x28,5cm (ΜxΠxΥ)	1
03719	Γ/12(12συσ.) 27x34x55cm (ΜxΠxΥ)	1
04271	Γ/18(18συσ.) 27x34x82cm (ΜxΠxΥ)	1
04250	Γ/36(36συσ.) 27x34x162cm (ΜxΠxΥ)	1

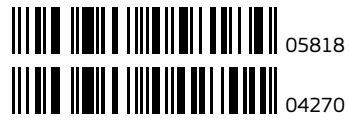

ΣΥΡΤΑΡΟΘΗΚΕΣ ΣΕΙΡΑ Η

Barcode	Icon	Icon
05818	Η/3(3συσ.) 41x34x28,2cm (ΜxΠxΥ)	1
04270	Η/18(18συσ.) 41x34x162cm (ΜxΠxΥ)	1



07251

02265



04249



Κουτί K/2 = M24xΠ17xY11,8cm

ΦΟΡΙΑΜΟΙ ΣΕΙΡΑ Δ (με κουτιά K/2)

Barcode	Product Name	Dimensions (MxΠxY)	Quantity
07251	Δ/8(8συσ.)	23x37,5x55cm	1
04249	Δ/12(12συσ.)	23x37,5x82cm	1
02265	Δ/24(24συσ.)	23x37,5x162cm	1



03087

09445

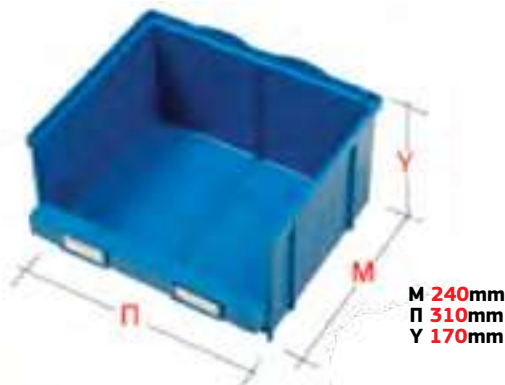

Κουτί K/304 = M24xΠ31xY17cm

ΦΟΡΙΑΜΟΙ ΣΕΙΡΑ Ε (με κουτιά K/304)

Barcode	Product Name	Dimensions (MxΠxY)	Quantity
03087	Ε/9(9συσ.)	27x34x162cm	1
09445	Ε/10(10συσ.)	27x34x180cm	1

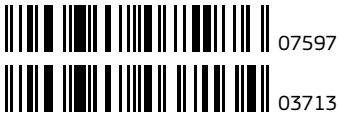

07597

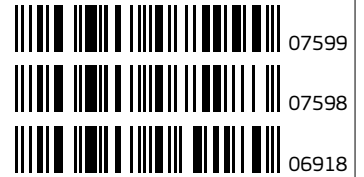

07599



*Συρτάρι H = M40xΠ31xΥ7cm
Κουτί K/305 = M40xΠ31xΥ17cm

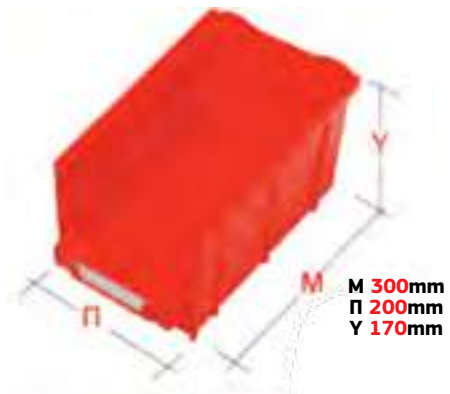

Κουτί K/303 = M30xΠ20xΥ17

ΦΟΡΙΑΜΟΙ ΣΕΙΡΑ Z (με κουτιά K/305)

Barcode	Icon	Model	Dimensions (MxΠxΥ)	Quantity
07597	Z/4/1	(4συρ.) 41x34x82cm	(MxΠxΥ)	1
03713	Z/9	(9συρ.) 41x34x162cm	(MxΠxΥ)	1

ΦΟΡΙΑΜΟΙ ΣΕΙΡΑ K (με κουτιά K/303)

Barcode	Icon	Model	Dimensions (MxΠxΥ)	Quantity
07599	K/8/2	(8συρ.) 31x43x82cm	(MxΠxΥ)	1
07598	K/18	(18συρ.) 31x43x162cm	(MxΠxΥ)	1
06918	K/22	(22συρ.) 31x43x198cm	(MxΠxΥ)	1

08116	05283	08647	03984
04087	07322	06568	04492
01829	07494	04327	04060
04635	04020	04055	04073
07309	04063	01830	07495
07180	04080	03983	05304
04072			
04632			



ΕΠΙΤΟΙΧΗ ΜΕ ΡΑΦΙΑ
Y=2,00m M=1,00m B=0,50m



ΕΠΙΤΟΙΧΗ ΜΕ ΔΙΑΤΡΗΤΗ ΠΛΑΤΗ
Y=2,00m M=1,00m B=0,50m



ΚΟΛΩΝΑ Π1 ΛΕΥΚΗ
27x18X2mm

08116	1,20m	1
04087	1,60m	1
01829	2,00m	1
04635	2,40m	1

ΚΟΛΩΝΑ ΒΑΡΕΩΣ ΤΥΠΟΥ
ΛΕΥΚΗ 60x30X2,5mm

07309	1,20m	1
07180	1,40m	1
04072	1,60m	1
04632	1,80m	1
05283	2,00m	1
07322	2,20m	1
07494	2,40m	1

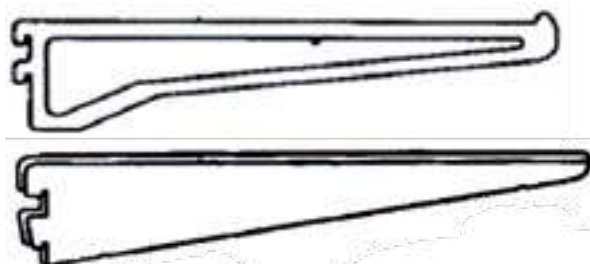

ΠΡΟΒΟΛΙΚΑ ΔΙΠΛΑ

04327	20cm	1
04055	25cm	1
01830	30cm	1
03983	35cm	1
03984	40cm	1
04492	50cm	1

ΠΡΟΒΟΛΙΚΑ ΜΟΝΑ

04063	30cm	1
04080	40cm	1
08647	50cm	1
06568	60cm	1

ΠΕΛΜΑ ΠΟΔΑΡΙΚΟΥ

04020	Ρυθμιζόμενο	1



ΠΟΔΑΡΙΚΟ ΒΑΣΗΣ

04060	30cm	1
04073	40cm	1
07495	50cm	1
05304	60cm	1

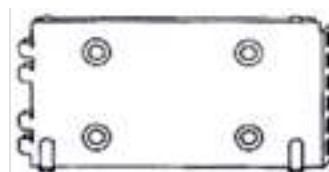



ΠΛΑΤΗ ΑΠΛΗ ΛΕΥΚΗ

Barcode	Icon	Code	Icon
05074		57x17cm	1
04053		57x40m	1
06880		72x17cm	1
04047		72x40cm	1
08873		97x17cm	1
04048		97x40m	1
07503		122x17cm	1
08644		122x40cm	1

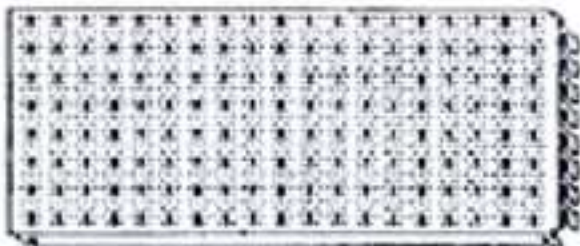

ΠΛΑΤΗ ΔΙΑΤΡΗΤΗ ΛΕΥΚΗ Π1

Barcode	Icon	Code	Icon
06614		57x20cm	1
07562		72x20cm	1
07784		97x20cm	1
07561		122x20cm	1

ΠΛΑΤΗ ΔΙΑΤΡΗΤΗ ΛΕΥΚΗ ΒΑΡΕΩΣ ΤΥΠΟΥ

Barcode	Icon	Code	Icon
04054		57x40cm	1
04092		72x40cm	1
04093		97x40cm	1
04281		122x40cm	1



ΓΑΝΤΖΟΣ ΜΟΝΟΣ

Barcode	Icon	Code	Icon
13102		5cm - Ø4mm	50
05928		10cm - Ø4mm	50
05297		15cm - Ø4mm	50
05296		19cm - Ø5mm	50
05307		25cm - Ø5mm	50
01156		27cm - Ø5mm	50
03592		36cm - Ø5,5mm	50

ΓΑΝΤΖΟΣ ΔΙΠΛΟΣ

Barcode	Icon	Code	Icon
08245		15cm - Ø4mm	50
04031		19cm - Ø4mm	50
01016		23cm - Ø4mm	50
01176		28cm - Ø4mm	50
10128		40cm - Ø4mm	50



ΚΑΠΑΚΙ ΓΟΝΔΟΛΑΣ

Barcode	Icon	Code	Icon
04082		72cm	1
08874		97cm	1
06757		122cm	1

	10097		04044
	04061		13454
	04077		04085
	04065		04084
	14500		07499
	04062		10706
	04076		



ΡΑΦΙΑ ΠΑΤΟΥΡΑΣ ΕΝΙΣΧΥΜΕΝΑ

10097	57x40cm	1
04061	72x30cm	1
04077	72x40cm	1
04065	72x50cm	1
14500	72x60cm	1
04062	97x30cm	1
04076	97x40cm	1
04044	97x50cm	1
13454	97x60cm	1
04085	122x30cm	1
04084	122x40cm	1
07499	122x50cm	1
10706	122x60cm	1

	07497		04022
	01777		



ΠΡΟΒΟΛΙΚΑ ΟΡΟΦΗΣ

07497	30cm	1
01777	40cm	1
04022	50cm	1

ΓΟΝΔΟΛΑ ΜΕ ΡΑΦΙΑ
Y=1,40m M=1,00m B=0,50m



ΓΟΝΔΟΛΑ ΜΕ ΔΙΑΤΡΗΤΗ ΠΛΑΤΗ
Y=1,60m M=1,00m B=0,50m



	05736		04045
	05236		04066



ΚΟΡΝΙΖΑ ΔΙΑΦΑΝΗ

05736	57cm	1
05236	72cm	1
04045	97cm	1
04066	122cm	1

	06968		07502
	04094		



ΦΙΛΜ ΚΟΡΝΙΖΑΣ ΧΡΩΜΑΤΙΣΤΟ

06968	72cm	1
04094	97cm	1
07502	120cm	1

	07550		04019
	04021		06911



ΚΟΥΤΕΛΟ (ΜΠΑΖΟ)

07550	60x17cm	1
04021	72x17cm	1
04019	97x17cm	1
06911	122x17cm	1



ΣΤΑΝΤ ΓΚΡΙ 5 ΡΑΦΙΑ

Barcode	Icon	Volume
05146		100x30x200cm (ΠxΒxΥ) 1



07361



05656



04568



08666



05176



05409



07414



ΓΩΝΙΑ ΝΤΕΞΙΟΝ T36x36mm

Barcode	Icon	Volume
07361		2,00m (Γαλβανιζέ) 1
04568		2,00m (Γκρι) 1
05176		2,00m (Λευκή) 1
07414		2,44m (Γαλβανιζέ) 1
05656		2,44m (Γκρι) 1
08666		3,05m (Γαλβανιζέ) 1
05409		3,05m (Γκρι) 1



01742



05171



01986



ΓΩΝΙΑ ΝΤΕΞΙΟΝ T40x40mm

Barcode	Icon	Volume
01742		2,00m (Γκρι) 1
05171		2,44m (Γκρι) 1
01986		3,05m (Γκρι) 1



ΠΕΛΜΑ ΠΛΑΣΤΙΚΟ ΓΙΑ ΝΤΕΞΙΟΝ

Barcode	Icon	Volume
04570		T36 1

	06784		01025
	05179		04569
	05253		06557
	05188		00018
	07431		02315
	05178		05172
	06288		00724
	07416		04688
	08668		07415
	08669		04571
	10707		01407
	05177		



**ΡΑΦΙ ΝΤΕΞΙΟΝ
ΛΕΥΚΟ**

06784	92x30cm	1
05179	92x38cm	1
05253	92x46cm	1
05188	92x61cm	1
07431	122x30cm	1
05178	122x38cm	1
06288	122x61cm	1

**ΡΑΦΙ ΝΤΕΞΙΟΝ
ΓΑΛΒΑΝΙΖΕ**

07416	92x30cm	1
08668	92x46cm	1
08669	122x46cm	1

**ΡΑΦΙ ΝΤΕΞΙΟΝ
ΓΚΡΙ**

10707	72x30cm	1
05177	72x38cm	1
01025	92x30cm	1
04569	92x38cm	1
06557	92x46cm	1
00018	92x61cm	1
02315	122x30cm	1
05172	122x38cm	1
00724	122x46cm	1
04688	122x61cm	1



ΚΟΜΒΟΕΛΑΣΜΑ

07415	Γαλβανιζέ	1
04571	Γκρι	1
01407	Λευκό	1



	08154		14494
	11958		12094
	11615		15354
	11616		06636
	15352		07212
	07081		07242



ΠΛΑΙΣΙΟ S1 ΓΑΛΒΑΝΙΖΕ

08154	1972x320mm (YxB)	1
11958	1972x400mm (YxB)	1
11615	1972x500mm (YxB)	1
11616	1972x600mm (YxB)	1
15352	1972x800mm (YxB)	1
07081	3028x400mm (YxB)	1
14494	3028x500mm (YxB)	1v
12094	3028x600mm (YxB)	1

ΠΛΑΙΣΙΟ S2 ΓΑΛΒΑΝΙΖΕ

15354	1972x600mm (YxB)	1
06636	2500x400mm (YxB)	1

ΠΕΛΜΑ ΜΕΤΑΛΛΙΚΟ ΓΑΛΒΑΝΙΖΕ

07212	Απλό	1

ΚΑΠΑΚΙ ΚΟΛΩΝΑΣ ΠΛΑΣΤΙΚΟ

07242	Απλό	1

ΡΑΦΙΑ ΒΑΡΕΩΣ ΤΥΠΟΥ

	07366		08150		07349		07210
	07224		08001		08151		07549
	07336		07338		07548		12250
	07320		07225		06462		07264
	07434		08622		08000		07211
	07207		12650		07592		07545
	07241		07337		07245		12251



ΔΟΚΙΔΑ S1 ΓΑΛΒΑΝΙΖΕ

07366	600mm	1
07224	900mm	1
07336	1200mm	1
07320	1500mm	1

ΔΟΚΙΔΑ S2 ΓΑΛΒΑΝΙΖΕ

07434	900mm	1
07207	1200mm	1
07241	1500mm	1

ΔΟΚΙΔΑ S2 ΓΑΛΒΑΝΙΖΕ

08150	1500mm	1
08001	1800mm	1

ΡΑΦΙ H12 ΓΑΛΒΑΝΙΖΕ

07338	450x320mm (MxB)	1
07225	450x400mm (MxB)	1
08622	450x500mm (MxB)	1
12650	450x600mm (MxB)	1
07337	600x320mm (MxB)	1
07349	600x400mm (MxB)	1
08151	600x500mm (MxB)	1
07548	600x600mm (MxB)	1

ΣΚΑΦΑΚΙ ΓΑΛΒΑΝΙΖΕ

07245	300x320mm (MxB)	1
07210	300x400mm (MxB)	1
07549	300x600mm (MxB)	1
12250	600x500mm (MxB)	1

ΧΩΡΙΣΜΑ ΓΙΑ ΣΚΑΦΑΚΙ ΓΑΛΒΑΝΙΖΕ

07264	320mm (B)	1
07211	400mm (B)	1
07545	500mm (B)	1
12251	600mm (B)	1

		900				1200				1500				1800									
		S0	S1	S2	S3	S0	S1	S2	S3	S1G	S2G	S3G	S3	S1	S2	S3	S1G	S2G	S3G	S3	S1G	S2G	S3G
320	H12	200	280	305	305	150	205	275	320	350	425	425	145	175	205	350	515	515	140	310	430	530	
	H12	200	235	235	235	150	205	275	320	350	330	330	145	175	205	350	400	400	140	310	430	470	
	H25 A	200	280	390	450	150	205	275	320	350	520	640	145	175	205	350	520	640	140	310	430	530	
	H25 B	200	280	390	450	150	205	275	320	350	520	640	145	175	205	350	520	640	140	310	430	530	
400	H12	200	280	390	450	150	205	275	320	350	520	640	145	175	205	350	520	640	140	310	430	530	
	H12	185	185	185	185	150	205	260	260	260	260	260	145	175	205	315	315	315	140	310	370	370	
	H25 A	200	280	390	420	150	205	275	320	350	520	640	145	175	205	350	520	640	140	310	430	530	
	H25 B	200	280	390	450	150	205	275	320	350	520	640	145	175	205	350	520	640	140	310	430	530	
600	H12	200	280	390	450	150	205	275	320	350	520	640	145	175	205	350	520	640	140	310	430	530	
	H12	150	150	150	150	150	205	210	210	210	210	210	145	175	205	280	280	280	140	305	305	305	
	H25 A	200	280	345	345	150	205	275	320	350	480	480	145	175	205	350	520	640	140	310	430	530	
	H25 B	200	280	390	390	150	205	275	320	350	520	520	145	175	205	350	520	640	140	310	430	530	
700	H12	200	280	390	450	150	205	275	320	350	520	640	145	175	205	350	520	640	140	310	430	530	
	H12	130	130	130	130	150	180	180	180	180	180	180	145	175	205	220	220	220	140	280	260	260	
	H25 A	200	280	285	285	150	205	275	320	350	380	380	145	175	205	350	520	475	140	310	430	530	
	H25 B	200	280	330	330	150	205	275	320	350	440	440	145	175	205	350	520	550	140	310	430	530	
800	H12	200	280	390	450	150	205	275	320	350	520	640	145	175	205	350	520	640	140	310	430	530	
	H12		80	80	80		115	115	115	115	115	115	130	140	140	140	140	140					
	H25 A		230	230	230		180	250	290	340	340	340	130	160	180	350	425	425					
	H25 B		250	280	260		180	250	290	350	380	380	130	160	180	350	475	475					
800	H25 C		250	390	390		180	250	290	350	520	580	130	160	180	350	520	640					

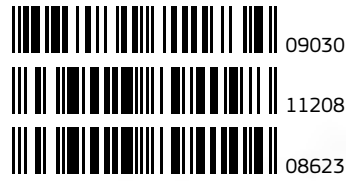

ΦΟΡΜΑ ΟΛΟΣΩΜΗ FIRST ΛΕΥΚΗ ΓΙΑ ΧΗΜΙΚΑ

Barcode	Icon	Icon
09030	XXL	5

ΦΟΡΜΑ ΟΛΟΣΩΜΗ ΜΙΑΣ ΧΡΗΣΗΣ

Barcode	Icon	Icon
11208	XL	10
08623	XXL	10



ΦΟΡΜΑ ΜΕ ΤΙΡΑΝΤΑ POL/COT

Barcode	Icon	Icon
05126	M	10
05277	L	10
05279	XL	10
05275	XXL	10
08938	XXXL	10
02996	4XL	1
04640	5XL	1

ΦΟΡΜΑ ΟΛΟΣΩΜΗ ΕΡΓΑΣΙΑΣ ΒΑΜΒΑΚΕΡΗ

Barcode	Icon	Icon
04637	S	5
04636	M	5
04638	L	5
04639	XL	5
04723	XXL	5
05540	XXXL	5



ΜΠΛΟΥΖΑΚΙ POLO ΓΚΡΙ

Barcode	Icon	Icon
08617	XL	10

ΜΠΛΟΥΖΑΚΙ ΜΑΚΟ T-SHIRT ΧΡΩΜΑΤΙΣΤΟ

Barcode	Icon	Icon
08678	Διάφορα μεγέθη*	10

*Ποικιλία χρωμάτων



ΝΙΤΣΕΡΑΔΑ ΚΑΜΠΑΡΝΤΙΝΑ ΚΙΤΡΙΝΗ

Barcode	Size	Quantity
04217	L	5
00928	XL	5
04218	XXL	5
03985	XXXL	5



ΝΙΤΣΕΡΑΔΑ ΚΟΣΤΟΥΜΙ ΚΙΤΡΙΝΗ

Barcode	Size	Quantity
03988	L	5
03990	XL	5
03989	XXL	5
04170	XXXL	5



ΝΙΤΣΕΡΑΔΑ ΚΟΣΤΟΥΜΙ COMPACT ΜΠΛΕ

Barcode	Size	Quantity
08870	L	5
06444	XL	5
06443	XXL	5

GET IT NOW



ΝΙΤΣΕΡΑΔΑ ΚΑΜΠΑΡΝΤΙΝΑ ΧΑΚΙ

Barcode	Size	Quantity
04172	L	5
04169	XL	5
03986	XXL	5
03987	XXXL	5



ΝΙΤΣΕΡΑΔΑ ΚΟΣΤΟΥΜΙ ΧΑΚΙ

Barcode	Size	Quantity
00927	L	5
04216	XL	5
00990	XXL	5
04171	XXXL	5



ΝΙΤΣΕΡΑΔΑ ΚΟΣΤΟΥΜΙ COMPACT ΠΡΑΣΙΝΗ

Barcode	Size	Quantity
08871	L	5
06423	XL	5
06442	XXL	5

GET IT NOW



ΖΩΝΗ ΣΤΡΑΤΙΩΤΙΚΗ ΤΥΠΟΥ Α/Τ

11347	Μαύρο, Μπλε, Χακί	5



ΕΠΙΓΟΝΑΤΙΔΕΣ ΜΑΡΜΑΡΑΔΩΝ

03475	Μαύρες	5



ΕΠΙΓΟΝΑΤΙΔΕΣ ΜΑΡΜΑΡΑΔΩΝ 72803

11314	Μαύρες	6



ΕΠΙΓΟΝΑΤΙΔΕΣ ΜΑΡΜΑΡΑΔΩΝ

04581	Μπλε	4

06426
03501



ΚΡΑΝΟΣ ΕΡΓΑΤΩΝ

Barcode	Color	Quantity
06426	Κίτρινο	5
03501	Πορτοκαλί	5

04509
04508



ΓΙΛΕΚΟ ΑΝΑΚΛΑΣΤΙΚΟ XL 64x64cm

Barcode	Color	Quantity
04509	Κίτρινα / Γκρι	5
04508	Πορτοκαλί / Γκρι	5

05847



ΩΤΑΣΠΙΔΕΣ ΤΑΪΒΑΝ

Barcode	Color	Quantity
05847	Ρυθμιζόμενες	5

00360



ΣΕΤ ΠΡΟΣΤΑΣΙΑΣ ΠΡΟΣΩΠΟΥ ΤΑΪΒΑΝ

Barcode	Quantity	Quantity
00360	3 τμχ.	6

03473
03474



ΚΩΝΟΙ ΣΗΜΑΝΣΕΩΣ ΔΡΟΜΟΥ

Barcode	Size	Quantity
03473	32cm	20
03474	54cm	10



14293



NEW ARRIVAL

HOT SELLER

- Επικάλυψη νιτριλίου.
- Παλάμη ανθεκτική σε κοψίματα από μαχαίρι, γυαλί.
- Κατάλληλα για ελαφριές εργασίες DIY και δουλειές σπιτιού.
- Εσωτερικό κέλυφος άνετο στο χέρι που επιτρέπει να αναπνέει.

ΓΑΝΤΙΑ NYLON-NITRILE

Barcode	Icon	Icon
14293	7/S	12
14294	8/M	12
14295	9/L	12
14296	10/XL	12
14297	11/XXL	12



CE Cat. II

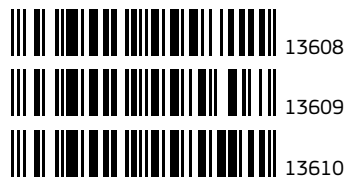

13608



NEW ARRIVAL

ΓΑΝΤΙΑ ΟΔΗΓΩΝ ΔΕΡΜΑΤΙΝΑ

Barcode	Icon	Icon
13608	9/L	12
13609	10/XL	12
13610	11/XXL	12

- Γάντια οδηγού υψηλής ποιότητας από δέρμα μοσχαριού.

CE Cat. I

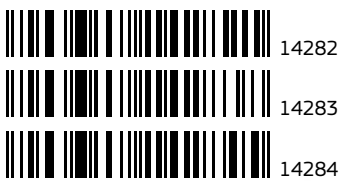

14282



NEW ARRIVAL

- Γάντια οδηγού υψηλής ποιότητας από δέρμα χοίρου.
- Ανθεκτικά με άνετη εφαρμογή.
- Κατάλληλα για οδηγούς, χειριστές μηχανημάτων και γενικές εργασίες.

ΓΑΝΤΙΑ ΟΔΗΓΩΝ ΔΕΡΜΑΤΙΝΑ (A)

Barcode	Icon	Icon
14282	9/L	12
14283	10/XL	12
14284	11/XXL	12



CE Cat. II



14285



NEW ARRIVAL

- Γάντια οδηγού υψηλής ποιότητας από δέρμα χοίρου.
- Ανθεκτικά με άνετη εφαρμογή.
- Κατάλληλα για οδηγούς, χειριστές μηχανημάτων και γενικές εργασίες.

ΓΑΝΤΙΑ ΟΔΗΓΩΝ ΔΕΡΜΑΤΙΝΑ (B)

Barcode	Icon	Icon
14285	9/L	12
14286	10/XL	12
14287	11/XXL	12
14288	12/XXXL	12



CE Cat. II

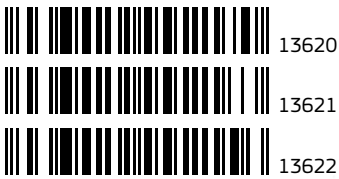

NEW
ARRIVAL



ΓΑΝΤΙΑ ΜΕ ΔΕΡΜΑ VELCRO

- Γάντια δέρμα με κούμπωμα velcro.
- Ανθεκτικά με άνετη εφαρμογή.
- Κατάλληλα για ελαφριές εργασίες γενικής χρήσης.

Barcode	Size	Quantity
13620	9/L	12
13621	10/XL	12
13622	11/XXL	12

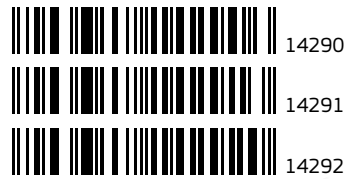

NEW
ARRIVAL



ΓΑΝΤΙΑ ΓΕΝΙΚΗΣ ΧΡΗΣΗΣ ΔΕΡΜΑΤΙΝΑ

- Γάντια από δέρμα μόσχου κρούτα.
- Ανθεκτικά με άνετη εφαρμογή.
- Κατάλληλα για εργασίες γενικής χρήσης.

Barcode	Size	Quantity
14290	9/L	12
14291	10/XL	12
14292	11/XXL	12



NEW
ARRIVAL



ΓΑΝΤΙΑ ΕΡΓΑΣΙΑΣ ΔΕΡΜΑΤΟΠΑΝΙΝΑ

- Ανθεκτικά με άνετη εφαρμογή.
- Κατάλληλα για εργασίες γενικής χρήσης.

Barcode	Size	Quantity
13618	9/L	12
13619	10/XL	12

CE Cat. I



NEW
ARRIVAL



ΓΑΝΤΙΑ ΗΛΕΚΤΡΟΣΥΓΚΟΛΛΗΤΩΝ ΕΝΙΣΧΥΜΕΝΑ (A)

- Ανθεκτικά με άνετη εφαρμογή.
- Κατάλληλα για εργασίες ηλεκτροσυγκόλλησης.

Barcode	Size	Quantity
11156	10/XL	12





NEW
ARRIVAL

- Ανθεκτικά με άνετη εφαρμογή.
- Κατάλληλα για εργασίες ηλεκτροσυγκόλλησης.

ΓΑΝΤΙΑ ΗΛΕΚΤΡΟΣΥΓΚΟΛΛΗΤΩΝ ΕΝΙΣΧΥΜΕΝΑ (B)

00279	10/XL	12

EN388:2016



41MAX



01109



11165



NEW
ARRIVAL

- Ανθεκτικά με άνετη εφαρμογή.
- Με εσωτερική βαμβακερή επένδυση.
- Κατάλληλα για εργασίες σε πετρελαιοειδή και λιπαντικά.

ΓΑΝΤΙΑ ΠΕΤΡΕΛΑΙΟΥ

01109	30cm	12
11165	35cm	12

EN 388



3121X



NEW
ARRIVAL

- Ανθεκτικά με άνετη εφαρμογή.
- Εμβαπτισμένα σε NBR.
- Ελαστική μανσέτα ασφαλείας.
- Κατάλληλα για εργασίες σε λιπαντικά.

ΓΑΝΤΙΑ ΕΜΒΑΠΤΙΣΜΕΝΑ ΜΕ ΜΑΝΣΕΤΑ

11172	10/XL	12

EN 388



4111X



NEW
ARRIVAL

- Ανθεκτικά με άνετη εφαρμογή.
- Σαγρέ επιφάνεια.
- Βαμβακερή μανσέτα ασφαλείας.
- Κατάλληλα για εργασίες σε πέτρες και τζάμια.

ΓΑΝΤΙΑ ΠΕΤΡΑΣ ΣΑΓΡΕ

01259	10/XL	12

CE Cat.I

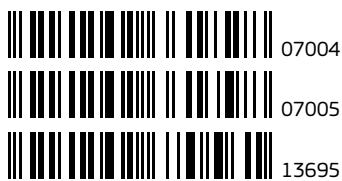

GET IT NOW
HOT SELLER

BELLOTA



•Γάντια γενικής χρήσης από χημικό δίχρωμο λατέξ.
•Ανθεκτικό έναντι της μεθανόλης και του υδροξειδίου του νατρίου.

ΓΑΝΤΙΑ LATEX ΧΗΜΙΚΟ 72172

Barcode	Size	Quantity
07004	9/L	10
07005	10/XL	10
13695	11/XXL	10

CE Cat.I



BELLOTA



ΓΑΝΤΙΑ KEVLAR 72175

•Υλικό Kevlar με ίνα κατά της κοπής
•Ελαστική μανσέτα για καλύτερη εφαρμογή.

Barcode	Size	Quantity
08143	9/L	10



CE Cat.II



BELLOTA



•Γάντια από βουρτσισμένο κατσικίσιο δέρμα.
•Υψηλός βαθμός άνεσης για το χρήστη.

ΓΑΝΤΙΑ ΔΕΡΜΑ 72167

Barcode	Size	Quantity
03764	9/L	10
06361	10/XL	10
13694	11/XXL	10



CE Cat.II

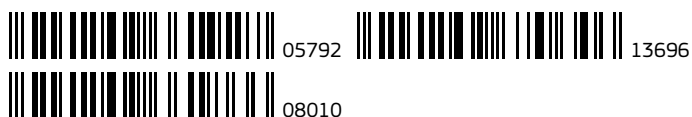

BELLOTA



ΓΑΝΤΙΑ ΔΕΡΜΑ ΚΡΟΥΤΑΣ 72177

•Γάντια από κατσικίσιο δέρμα.
•Μεγάλη άνεση και πολύ καλή αναπνοή.
•Φόδρα στη παλάμη και τα δάκτυλα.

Barcode	Size	Quantity
05792	9/L	10
08010	10/XL	10
13696	11/XXL	10

CE Cat.I

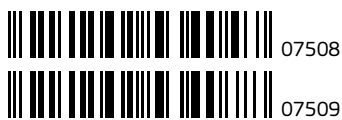

BELLOTA



- Γάντια από 100% νάιλον και λάτεξ με ραβδώσεις στη παλάμη.
- Ελαστικός καρπός.
- Κατάλληλα για μεταφύτευση και εργασίες συντήρησης κήπου.

ΓΑΝΤΙΑ ΚΗΠΟΥ NYLON ΜΕ ΕΠΙΣΤΡΩΣΗ LATEX 75102

Barcode	Clipboard	Box
07508	9/L	10
07509	10/XL	10

CE Cat. I

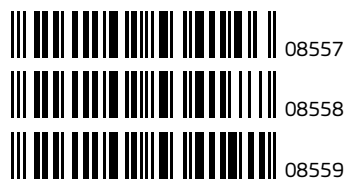

BELLOTA



- Γάντια από κατσίκισιο δέρμα, με βαμβακερή άνω πλευρά.
- Ενισχυμένος αντίχειρας και ελαστικός καρπός.
- Κατάλληλα για εργασίες συντήρησης κήπου.

ΓΑΝΤΙΑ ΚΗΠΟΥ 75104

Barcode	Clipboard	Box
08557	8/M	10
08558	9/L	10
08559	10/X	10

CE Cat. I

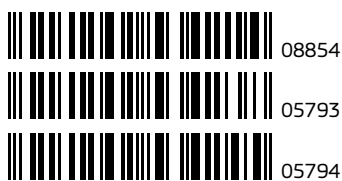

BELLOTA



- Γάντια από αγελαδινό δέρμα.
- Γκρι καστόρινο άνω μέρος.
- Κατάλληλα για κλάδεμα και εργασίες συντήρησης κήπου.

ΓΑΝΤΙΑ ΚΗΠΟΥ 75105

Barcode	Clipboard	Box
08854	8/M	10
05793	9/L	10
05794	10/XL	10

CE Cat. I



BELLOTA



- Γάντια από κατσίκισιο δέρμα σε γκρι χρώμα με πράσινο βαμβακερό άνω μέρος.
- Ενισχυμένος αντίχειρας, μακρύ μανίκι από πράσινο караβόπανο με ελαστικό τελείωμα.
- Κατάλληλα για κλάδεμα δένδρων, θάμνων και ακανθώδων φυτών.

ΓΑΝΤΙΑ ΣΥΓΚΟΜΙΔΗΣ ΜΕ ΜΑΚΡΙΑ ΜΑΝΙΚΙΑ 75106

Barcode	Clipboard	Box
07510	9/L	10
07511	10/XL	10

CE Cat. I



- Γάντια Latex 15gr.
- Ελαστική μανσέτα ασφαλείας.
- Κατάλληλα για εργασίες γενικής χρήσης.

ΓΑΝΤΙΑ LATEX ΓΚΡΙ-ΜΠΛΕ MACO - WILD 4540

Barcode	Size	Quantity
15233	9/L	12
15234	10/XL	12

EN 388



3131X

CE Cat II



- Αντιολισθητική παλάμη.
- Ελαστική μανσέτα ασφαλείας.
- Κατάλληλα για εργασίες γενικής χρήσης.

ΓΑΝΤΙΑ LATEX ΤΙΡΚΟΥΑΖ-ΜΩΒ MACO-STRONG 4530

Barcode	Size	Quantity
15231	9/L	12
15232	10/XL	12

EN 388



2131X

CE Cat II

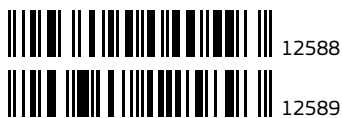

- Νάιλον 13 gauge χωρίς ραφές.
- Τεχνολογία Grip επικάλυψης παλάμης με νιτριλίου που δημιουργεί κανάλι διαφυγής νερού.
- Κατάλληλα για μηχανικές εργασίες, αποθήκες εμπορευμάτων και οικιακή χρήση.

ΓΑΝΤΙΑ ΝΙΤΡΙΛΙΟΥ MACO-GRIP 4050

Barcode	Size	Quantity
12588	9/L	12
12589	10/XL	12

EN 388



4121

CE Cat II

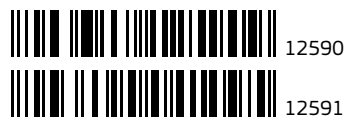

- Νάιλον 15 gauge με επικάλυψη νιτριλίου.
- Αδιαβροχοποιημένο ύφασμα.
- Υλικό Micro foam στη παλάμη για να αναπνέει το χέρι.
- Παλάμη νιτριλίου που δεν χαράζεται εύκολα με μαχαίρι
- Ειδικό σχήμα για τέλεια εφαρμογή, κατάλληλο για βιομηχανική χρήση.

ΓΑΝΤΙΑ ΝΙΤΡΙΛΙΟΥ ΑΔΙΑΒΡΟΧΑ MACO-PLUS 4100

Barcode	Size	Quantity
12590	9/L	12
12591	10/XL	12

EN 388



4130

CE Cat II

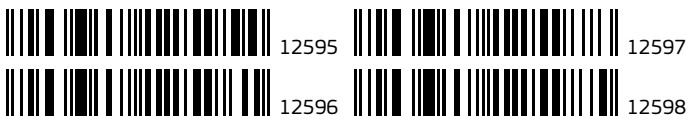

12595

12597



12596

12598



- Παλάμη με επικάλυψη φυσικού ελαστικού.
- Αδιαβροχοποιημένο ύφασμα.
- Βιοδιασπώμενο bamboo κέλυφος χωρίς προσθήκη χημικών.
- Υφασμα bamboo που διατηρεί το χέρι χωρίς ιδρώμα 4 φορές περισσότερο από νάιλον υφασμα.
- Περιέχει φυσικό καουτσούκ και είναι κατάλληλο για εργασίες κηπουρικής.

ΓΑΝΤΙΑ ΝΙΤΡΙΛΙΟΥ ΑΔΙΑΒΡΟΧΑ MACO-BAMBOO 4150

Barcode	Size	Quantity
12595	7/S	12
12596	8/M	12
12597	9/L	12
12598	10/XL	12

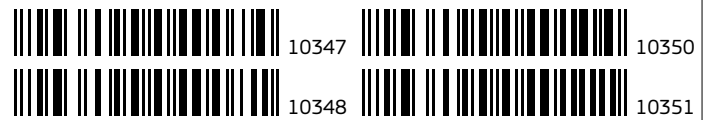

10347

10350

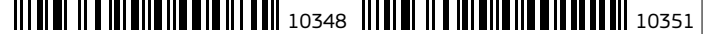

10348

10351



**HOT
SELLER**

- Επικάλυψη νιτριλίου.
- Παλάμη ανθεκτική σε κοψίματα από μαχαίρι, γυαλί.
- Κατάλληλα για ελαφριές εργασίες DIY και δουλειές σπιτιού.
- Εσωτερικό κέλυφος άνετο στο χέρι που επιτρέπει να αναπνεύει.

ΓΑΝΤΙΑ NYLON-NITRILE MACO-GENERAL 4000

Barcode	Size	Quantity
10347	7/S	12
10348	8/M	12
10349	9/L	12
10350	10/XL	12
10351	11/XXL	12

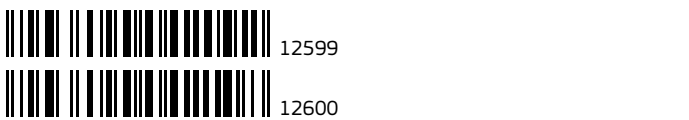

12599

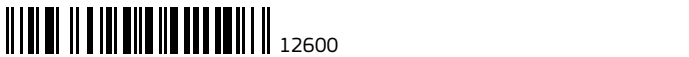

12600



- Κέλυφος Terylene / Cotton με επικάλυψη φυσικού ελαστικού στη παλάμη.
- Ανάγλυφη υφή παλάμης για αντιολισθητικό κράτημα.
- Σχεδιασμένο για χρήση σε στεγνές και υγρές επιφάνειες.
- Άνετα και ανθεκτικά κατάλληλα για επαγγελματική χρήση.

ΓΑΝΤΙΑ LATEX MACO-LATEX 4200

Barcode	Size	Quantity
12599	9/L	12
12600	10/XL	12

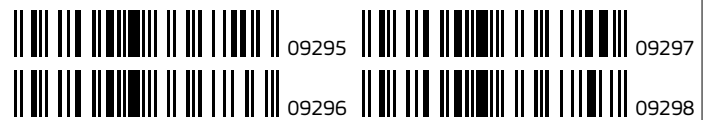

09295

09297



09296

09298



- Γάντια νιτριλίου εξαιρετικής ευαισθησίας και πρόσφυσης.
- Πέλμα από νάιλον υψηλής ποιότητας με πολύ καλό αερισμό
- Γενικής χρήσης.

ΓΑΝΤΙΑ ΕΡΓΑΣΙΑΣ ΝΙΤΡΙΛΙΟΥ

Barcode	Size	Quantity
09295	7/S	12
09296	8/M	12
09297	9/L	12
09298	10/XL	12





- Δέρμα αδιάβροχο από πρόσωπο μόσχου.
- Πίσω επιφάνεια από βαμβακερό ύφασμα.
- Μανσέτα ασφαλείας βαμβακερή.

ΓΑΝΤΙΑ ΕΡΓΑΣΙΑΣ ΧΟΙΡΟΔΕΡΜΑ ΡΑΣΑ

11157	10/XL	12



- Δέρμα παλάμης και ενίσχυση παλάμης από αδιάβροχο πρόσωπο μόσχου.
- Πίσω επιφάνεια από βαμβακερό ύφασμα.
- Μανσέτα από κρούτα μόσχου.

ΓΑΝΤΙΑ ΔΕΡΜΑΤΟΠΑΝΙΝΑ ΔΕΗ

11179	10/XL	12



- Γάντια από βαμβακερό ύφασμα 8oz με παλάμη εμποτισμένη με μαύρες κουκίδες PVC.

ΓΑΝΤΙΑ ΚΗΠΟΥ ΠΛΕΚΤΑ ΜΕ ΜΠΙΜΠΙΚΙΑ

02366	10/XL	12



ΓΑΝΤΙΑ ΒΙΟΜΗΧΑΝΙΚΑ ΕΛΑΣΤΙΚΑ

04747	M - 80gr	10
02394	L - 80gr	12
04748	XL - 80gr	12
03887	XL - 180gr	12

- Γάντια από συνθετικό latex χωρίς εσωτερική επένδυση.



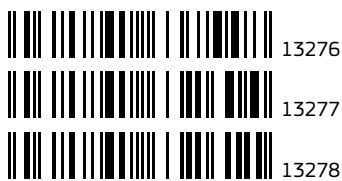

reflexx
IN SAFE HANDS



- Γάντια αντιολισθητικά με ελαφριά βαμβακερή επένδυση.
- Ανθεκτικό στα χημικά & στα λίπη, ασφαλές για τρόφιμα.
- Καλή χημική και μηχανική αντίσταση.

ΓΑΝΤΙΑ ΝΕΟΠΡΕΝΙΟΥ LATEX ΜΑΥΡΑ R101

Barcode	Size	Quantity
13276	8/M	10
13277	9/L	10
13278	10/XL	10

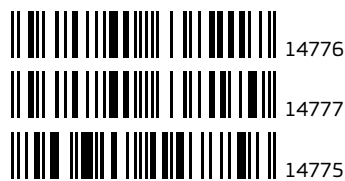

reflexx
IN SAFE HANDS



NEW ARRIVAL

- Πλεκτά συνθετικά γάντια χωρίς ραφή, με επίστρωση πολυουρεθάνης.
- Ελαστική μανσέτα ασφαλείας.
- Κατάλληλα για εργασίες γενικής χρήσης.
- Καλή επιδεξιότητα, πρόσφυση και μηχανική αντοχή.
- Δεν είναι κατάλληλο για εμβάπτιση.

ΓΑΝΤΙΑ ΠΟΛΥΟΥΡΕΘΑΝΗΣ ΓΚΡΙ

Barcode	Size	Quantity
14776	L	10
14777	XL	10
14775	XXL	10



ALDENA
HYPOALLERGENIC



- 100 % φυσικό latex.
- Μαλακή επιφάνεια, μπλέ χρώμα.
- Για εφαρμογές γενικής καθαριότητας.

ΓΑΝΤΙΑ LATEX ΜΠΛΕ ΜΙΑΣ ΧΡΗΣΕΩΣ 3,5gr

Barcode	Size	Quantity
11120	M	100
11121	L	100
11122	XL	100

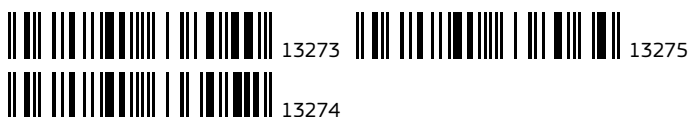

reflexx
IN SAFE HANDS



- Υψηλότερο πάχος που εγγυάται καλύτερη μηχανική αντοχή και πολύ μεγαλύτερη αντοχή στη διάτρηση.
- Ανθεκτικότητα στα έλαια, τα λίπη και σε μια μεγάλη ποικιλία χημικών ουσιών.
- Τραχιά επιφάνεια για αυξημένη πρόσφυση και ευαισθησία.
- Κατάλληλο για συνεργεία και εφαρμογές ελαφράς βιομηχανίας.

ΓΑΝΤΙΑ NITRILE ΜΑΥΡΑ ΜΙΑΣ ΧΡΗΣΕΩΣ 5,5GR R67

Barcode	Size	Quantity
13273	M	100
13274	L	100
13275	XL	100

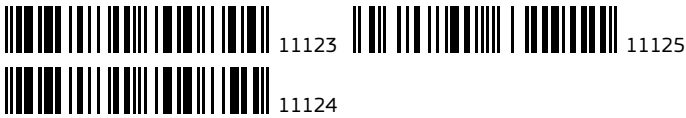

11123

11125



- Ειδική "μαλακή" σύνθεση για αυξημένη ελαστικότητα και ευαισθησία
- Σύνθεση που μειώνει τον κίνδυνο δερματίτιδας και μόλυνσης.
- Τραχιά επιφάνεια για αυξημένη πρόσφυση και ευαισθησία.
- Κατάλληλο για εφαρμογές γενικής καθαριότητας και ιατρικής.

ΓΑΝΤΙΑ NITRILE ΜΠΛΕ ΜΙΑΣ ΧΡΗΣΕΩΣ 3,5gr R76

11123	M	100
11124	L	100
11125	XL	100

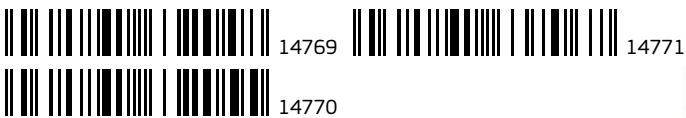

14769

14771



- Γάντια υψηλής αντίστασης, αμφιδέξια.
- 100% χωρίς λάτεξ.
- Αυξημένο πάχος και μήκος.
- Τραχιά επιφάνεια για αύξηση της πρόσφυσης και της ευαισθησίας.
- Κατάλληλα για εργασίες στη βιομηχανία, στα τρόφιμα, σε εργαστήρια και ασθενοφόρα, στη καθαριότητα.

ΓΑΝΤΙΑ NITRILE ΜΙΑΣ ΧΡΗΣΕΩΣ 8,8gr ΜΩΒ R99 NHR

14769	M	50
14770	L	50
14771	XL	50



13981

13983



- Τραχιά επιφάνεια για καλύτερη λαβή και ευαισθησία.
- Σύνθεση που μειώνει τον κίνδυνο δερματίτιδας και μόλυνσης.
- Κατάλληλο για εφαρμογές κομμωτηρίου, κοσμητικής ιατρικής, τατουάζ.

ΓΑΝΤΙΑ NITRILE ΜΑΥΡΑ ΜΙΑΣ ΧΡΗΣΕΩΣ 4gr R78

13981	M	100
13982	L	100
13983	XL	100



14034

14036



- Γάντια με λαβή σε ολόκληρη την παλάμη και τα δάχτυλα.
- Ειδική τρισδιάστατη λαβή και μεγάλο βάρος κάνουν το γάντι ιδιαίτερα κατάλληλο για βαριά χρήση.
- Παρέχει προστασία από χημικά και μικροοργανισμούς.
- Κατάλληλο για χρήση σε ελαφριά βιομηχανία, συνεργεία, μηχανικούς.

ΓΑΝΤΙΑ NITRILE ΠΟΡΤΟΚΑΛΙ ΜΙΑΣ ΧΡΗΣΕΩΣ 8,4gr N85

14034	M	50
14035	L	50
14036	XL	50
15302	XXL	50



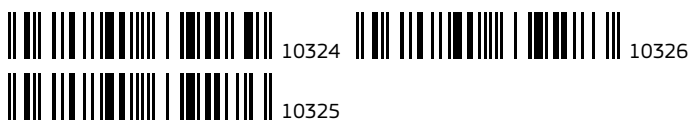

10324



10325

ΓΑΝΤΙΑ ΛΑΤΕΧ ΛΕΥΚΑ ΜΙΑΣ ΧΡΗΣΕΩΣ 4,8gr FP

- 100 % φυσικό latex με πούδρα
- Μαλακή επιφάνεια, λευκό χρώμα.
- Κατάλληλο για εφαρμογές γενικής καθαριότητας και τομείς κοσμητικής ιατρικής.

Barcode	Size	Quantity
10324	M	100
10325	L	100
10326	XL	100



ΓΥΑΛΙΑ ΠΡΟΣΤΑΣΙΑΣ MACO 6010 ΡΥΘΜΙΖΟΜΕΝΟΙ ΒΡΑΧΙΟΝΕΣ

Barcode	Color	Quantity
12846	Διάφανα	10



ΓΥΑΛΙΑ ΠΡΟΣΤΑΣΙΑΣ MACO 6011 ΡΥΘΜΙΖΟΜΕΝΟΙ ΒΡΑΧΙΟΝΕΣ

Barcode	Color	Quantity
12847	Διάφανα	10



ΕΚΘΕΤΗΡΙΟ ΓΥΑΛΙΩΝ

Barcode	Quantity	Unit
12850	20 Θέσεων	1



ΓΥΑΛΙΑ ΠΡΟΣΤΑΣΙΑΣ MACO 6013

Barcode	Color	Quantity
12848	Διάφανα	10

GET IT NOW



ΓΥΑΛΙΑ ΠΡΟΣΤΑΣΙΑΣ MACO 6014

Barcode	Color	Quantity
12849	Μαύρα	10



ΓΥΑΛΙΑ ΠΡΟΣΤΑΣΙΑΣ ΤΑΪΒΑΝ



02869



Κίτρινα



12



ΓΥΑΛΙΑ ΠΡΟΣΤΑΣΙΑΣ ΤΑΪΒΑΝ



03038



Πράσινα



12



ΓΥΑΛΙΑ ΠΡΟΣΤΑΣΙΑΣ ΤΑΪΒΑΝ



04164



Διάφανο



12



ΓΥΑΛΙΑ ΤΡΟΧΟΥ ΔΙΑΦΑΝΑ



00313



Standard



10



ΓΥΑΛΙΑ ΤΡΟΧΟΥ ΔΙΑΦΑΝΑ ΑΝΤΙΘΑΜΒΩΤΙΚΑ



11256



με βαλβίδα



10



ΓΥΑΛΙΑ ΔΙΠΛΑ ΤΑΪΒΑΝ ΗΛΕΚΤΡΟΣΥΓΚΟΛΛΗΤΩΝ



07291



10



ΜΑΣΚΑ ΧΗΜΙΚΗ ΜΟΝΗ ΤΑΪΒΑΝ

00886 RM603 12



ΜΑΣΚΑ ΟΛΟΚΛΗΡΟΥ ΠΡΟΣΩΠΟΥ ΠΑΝΟΡΑΜΙΚΗ

04698 CLIMAX 731 1



ΜΑΣΚΑ ΧΗΜΙΚΗ ΔΙΠΛΗ ΤΑΪΒΑΝ

02091 RM602 6



ΦΙΛΤΡΟ ΜΑΣΚΩΝ

00707 R611 5



ΦΙΛΤΡΟ ΜΑΣΚΑΣ ΟΛΟΚΛΗΡΟΥ ΠΡΟΣΩΠΟΥ

04699 A2-B2-E2-K2-P3 RD 1

ΒΑΣΙΚΗ ΚΩΔΙΚΟΠΟΙΗΣΗ ΦΙΛΤΡΩΝ ΚΑΤΑ EN 141 (ΦΙΛΤΡΑ ΑΕΡΙΩΝ) & EN 143 (ΦΙΛΤΡΑ ΣΩΜΑΤΙΔΙΩΝ)		
ΧΡΩΜΑ	ΤΥΠΟΣ	ΠΡΟΣΤΑΣΙΑ ΑΠΟ:
Green	A	Οργανικοί ατμοί και αέρια
Grey	B	Ανόργανοι ατμοί και αέρια
Yellow	E	Διοξείδιο θείου και ορισμένα όξινα αέρια
Red	K	Κυανίδια και ορισμένα οξυγονώδη αμίνια
Orange	AX	Οργανικοί ατμοί και αέρια (με σημείο βρασμού ≤ 65ο C)
White	P	Σωματίδια, σταγονίδια
Light Blue	Hg	Ατμοί υδραργύρου
Black	CO	Μονοξείδιο του άνθρακα
Light Blue	Reactor	Ραδιενεργός ιώδης
Light Blue	NO	Ιερωμένη οξείδια και ατμοί



Morgan.

ΜΑΣΚΑ ΜΙΑΣ ΧΡΗΣΕΩΣ 4500

00885		50



Πιστοποίηση για συμμόρφωση με τα Ευρωπαϊκά Πρότυπα ασφαλείας: **CE 0194**

Ευρωπαϊκό πρότυπο: **EN 149:2001 + A1:2009**

Περιγραφή προστασίας: Προστασία από αεροζόλ στερεά & υγρά μη τοξικά με συγκέντρωση έως 4,5 φορές του TLV (Treshold Limit Value : κατώτερο όριο επικινδυνότητας) ή έως 4 φορές το APF (Assumed Protection Factor: Υποτιθέμενος παράγοντας προστασίας ή επιτρεπόμενο όριο έκθεσης).

ΜΑΣΚΑ ΕΝΕΡΓΟΥ ΑΝΘΡΑΚΑ ΤΑΪΒΑΝ

02907	FFP1	20



Morgan.

Πιστοποίηση για συμμόρφωση με τα Ευρωπαϊκά Πρότυπα ασφαλείας

Ευρωπαϊκό πρότυπο: **EN 149:2001 + A1:2009**

Περιγραφή προστασίας: Προστασία από αεροζόλ στερεά & υγρά μη τοξικά με συγκέντρωση έως 4,5 φορές του TLV (Treshold Limit Value : κατώτερο όριο επικινδυνότητας) ή έως 4 φορές το APF (Assumed Protection Factor: Υποτιθέμενος παράγοντας προστασίας ή επιτρεπόμενο όριο έκθεσης).

ΜΑΣΚΑ ΕΝΕΡΓΟΥ ΑΝΘΡΑΚΑ 4501

05218	FFP1 (Σετ 2 τμχ.)	10



Morgan.

Πιστοποίηση για συμμόρφωση με τα Ευρωπαϊκά Πρότυπα ασφαλείας

Ευρωπαϊκό πρότυπο: **EN 149:2001 + A1:2009**

Περιγραφή προστασίας: Προστασία από αεροζόλ στερεά & υγρά μη τοξικά με συγκέντρωση έως 4,5 φορές του TLV (Treshold Limit Value : κατώτερο όριο επικινδυνότητας) ή έως 4 φορές το APF (Assumed Protection Factor: Υποτιθέμενος παράγοντας προστασίας ή επιτρεπόμενο όριο έκθεσης).

ΜΑΣΚΑ ΕΝΕΡΓΟΥ ΑΝΘΡΑΚΑ ΜΕ ΒΑΛΒΙΔΑ 4502

05597	FFP1 (Σετ 2 τμχ.)	8





Πιστοποίηση για συμμόρφωση με τα Ευρωπαϊκά Πρότυπα ασφαλείας: **CE 0086**
 Ευρωπαϊκό πρότυπο: **EN 149:2001 + A1:2009**
 Περιγραφή προστασίας: Προστασία από αεροζόλ στερεά & υγρά μη τοξικά με συγκέντρωση έως 4,5 φορές του TLV (Treshold Limit Value : κατώτερο όριο επικινδυνότητας) ή έως 4 φορές το APF (Assumed Protection Factor: Υποτιθέμενος παράγοντας προστασίας ή επιτρεπόμενο όριο έκθεσης).

ΜΑΣΚΑ ΜΕ ΒΑΛΒΙΔΑ PM022

11160	FFP1	20



Πιστοποίηση για συμμόρφωση με τα Ευρωπαϊκά Πρότυπα ασφαλείας: **CE 0086**
 Ευρωπαϊκό πρότυπο: **EN 149:2001 + A1:2009**
 Περιγραφή προστασίας: Προστασία από αεροζόλ στερεά & υγρά μη τοξικά με συγκέντρωση έως 4,5 φορές του TLV (Treshold Limit Value : κατώτερο όριο επικινδυνότητας) ή έως 4 φορές το APF (Assumed Protection Factor: Υποτιθέμενος παράγοντας προστασίας ή επιτρεπόμενο όριο έκθεσης).

ΜΑΣΚΑ ΕΝΕΡΓΟΥ ΑΝΘΡΑΚΑ PM023

11159	FFP1	20



Πιστοποίηση για συμμόρφωση με τα Ευρωπαϊκά Πρότυπα ασφαλείας: **CE 0086**
 Ευρωπαϊκό πρότυπο: **EN 149:2001 + A1:2009**
 Περιγραφή προστασίας: Προστασία από αεροζόλ στερεά & υγρά μη τοξικά με συγκέντρωση έως 4,5 φορές του TLV (Treshold Limit Value : κατώτερο όριο επικινδυνότητας) ή έως 4 φορές το APF (Assumed Protection Factor: Υποτιθέμενος παράγοντας προστασίας ή επιτρεπόμενο όριο έκθεσης).

ΜΑΣΚΑ ΕΝΕΡΓΟΥ ΑΝΘΡΑΚΑ ΜΕ ΒΑΛΒΙΔΑ PM024

11161	FFP1	20





Πιστοποίηση για συμμόρφωση με τα Ευρωπαϊκά Πρότυπα ασφαλείας: **CE 0086**

Ευρωπαϊκό πρότυπο: **EN 149:2001 + A1:2009**

Περιγραφή προστασίας: Προστασία από αεροζόλ στερεά & υγρά μη τοξικά, μέσης ή χαμηλής τοξικότητας με συγκέντρωση έως 12 φορές του TLV (Threshold Limit Value: κατώτερο όριο επικινδυνότητας) ή έως 10 φορές το APF (Assumed Protection Factor: Υποτιθέμενος παράγοντας προστασίας ή επιτρεπόμενο όριο έκθεσης).

ΜΑΣΚΑ ΕΝΕΡΓΟΥ ΑΝΘΡΑΚΑ ΜΕ ΒΑΛΒΙΔΑ PM029

11162	FFP2	20



Πιστοποίηση για συμμόρφωση με τα Ευρωπαϊκά Πρότυπα ασφαλείας: **CE 2233**

Ευρωπαϊκό πρότυπο: **EN 149:2001 + A1:2009**

Περιγραφή προστασίας: Προστασία από αεροζόλ στερεά & υγρά μη τοξικά, μέσης ή χαμηλής τοξικότητας με συγκέντρωση έως 12 φορές του TLV (Threshold Limit Value: κατώτερο όριο επικινδυνότητας) ή έως 10 φορές το APF (Assumed Protection Factor: Υποτιθέμενος παράγοντας προστασίας ή επιτρεπόμενο όριο έκθεσης).

ΜΑΣΚΑ 3D NC2

14696	FFP2	20



GET IT NOW



Πιστοποίηση για συμμόρφωση με τα Ευρωπαϊκά Πρότυπα ασφαλείας: **CE 0194**

Ευρωπαϊκό πρότυπο: **EN 149:2001 + A1:2009**

Περιγραφή προστασίας: Προστασία από αεροζόλ στερεά & υγρά μη τοξικά, μέσης ή χαμηλής τοξικότητας με συγκέντρωση έως 50 φορές του TLV (Threshold Limit Value: κατώτερο όριο επικινδυνότητας) ή έως 20 φορές το APF (Assumed Protection Factor: Υποτιθέμενος παράγοντας προστασίας ή επιτρεπόμενο όριο έκθεσης).

ΜΑΣΚΑ ΜΕ ΒΑΛΒΙΔΑ

11247	FFP3	5



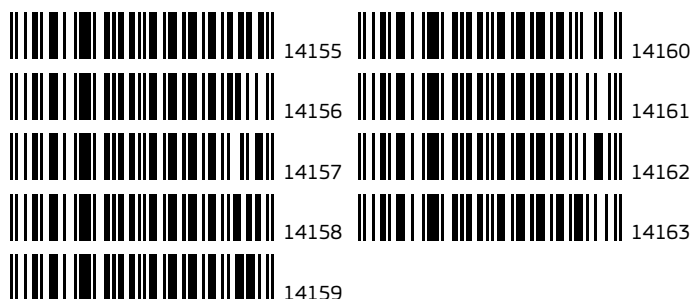

- Πιστοποιημένο προϊόν σύμφωνα με το πρότυπο EN ISO 20345: 11.
- Μεταλλική προστασία δακτύλων, απορρόφηση κραδασμών φτέρνας, αντιστατικές ιδιότητες.
- Εξωτερική σόλα διπλής πυκνότητας PU + PU ανθεκτική στα πετρελαιοειδή.
- Ενδιάμεση μεταλλική σόλα προστασίας.
- Άνω μέρος από ενισχυμένο δέρμα.
- Αδιάβροχο

ΜΠΟΤΑΚΙ ΑΣΦΑΛΕΙΑΣ S3 CLASSIC

Barcode	Size	Stock
14155	38	1
14156	39	1
14157	40	1
14158	41	1
14159	42	1
14160	43	1
14161	44	1
14162	45	1
14163	46	1



- Πιστοποιημένο προϊόν σύμφωνα με το πρότυπο EN ISO 20345: 11.
- Μεταλλική προστασία δακτύλων, απορρόφηση κραδασμών φτέρνας, αντιστατικές ιδιότητες.
- Εξωτερική σόλα διπλής πυκνότητας PU + PU ανθεκτική στα πετρελαιοειδή.
- Άνω μέρος από ενισχυμένο δέρμα.

ΜΠΟΤΑΚΙ ΑΣΦΑΛΕΙΑΣ S1 CLASSIC

Barcode	Size	Stock
14146	38	1
14147	39	1
14148	40	1
14149	41	1
14150	42	1
14151	43	1
14152	44	1
14153	45	1
14154	46	1

	14181		14185
	14182		14186
	14183		14187
	14184		14188



·Εξωτερική σόλα διπλής πυκνότητας PU + PU ανθεκτική στα πετρελαιοειδή.
·Άνω μέρος από στρώσεις δέρματος.

ΜΠΟΤΑΚΙ ΑΠΛΟ BLISS

14181	39	1
14182	40	1
14183	41	1
14184	42	1
14185	43	1
14186	44	1
14187	45	1
14188	46	1

	14205		14210
	14206		14211
	14207		14212
	14208		14213
	14209		



·Εξωτερική σόλα διπλής πυκνότητας PVC + PVC.
·Άνω μέρος από συνθετικό δέρμα.

ΜΠΟΤΑΚΙ ΑΠΛΟ TRENTON

14205	38	1
14206	39	1
14207	40	1
14208	41	1
14209	42	1
14210	43	1
14211	44	1
14212	45	1
14213	46	1



•Εξωτερική σόλα διπλής πυκνότητας EVA + RUBBER.
•Άνω μέρος από COWSUEDE + MESH.

ΜΠΟΤΑΚΙ ΟΡΕΙΒΑΣΙΑΣ HILLMAN

Barcode	Clipboard	Cube
14237	40	1
14238	41	1
14239	42	1
14240	43	1
14241	44	1
14242	45	1
14243	46	1



•Εξωτερική σόλα EVA + RUBBER ανθεκτική στα πετρελαιοειδή.
•Άνω μέρος από δέρμα ΚΡΥ.

ΠΑΠΟΥΤΣΙ CASUAL CASPER

Barcode	Clipboard	Cube
15016	40	1
15017	41	1
15018	42	1
15019	43	1
15020	44	1
15021	45	1
15022	46	1

NEW
ARRIVAL

	14166		14169
	14167		14170
	14168		14171



ΠΑΠΟΥΤΣΙ ΑΣΦΑΛΕΙΑΣ S1 CLASSIC

14166	40	1
14167	41	1
14168	42	1
14169	43	1
14170	45	1
14171	45	1



- Πιστοποιημένο προϊόν σύμφωνα με το πρότυπο EN ISO 20345: 11.
- Μεταλλική προστασία δακτύλων, απορρόφηση κραδασμών φτέρνας, αντιστατικές ιδιότητες.
- Εξωτερική σόλα διπλής πυκνότητας PU + PU ανθεκτική στα πετρελαιοειδή.
- Άνω μέρος από ενισχυμένο δέρμα.

	14189		14192		14195
	14190		14193		14196
	14191		14194		



ΠΑΠΟΥΤΣΙ ΑΣΦΑΛΕΙΑΣ S1P FENTON

14189	39	1
14190	40	1
14191	41	1
14192	42	1
14193	43	1
14194	44	1
14195	45	1
14196	46	1



- Πιστοποιημένο προϊόν σύμφωνα με το πρότυπο EN ISO 20345: 11.
- Μεταλλική προστασία δακτύλων, απορρόφηση κραδασμών φτέρνας, αντιστατικές ιδιότητες.
- Εξωτερική σόλα διπλής πυκνότητας PU + PU ανθεκτική στα πετρελαιοειδή.
- Ενδιάμεση μεταλλική σόλα προστασίας.
- Άνω μέρος από δέρμα KPU.

	14214		14217
	14215		14218
	14216		14219



ΜΠΟΤΑΚΙ CASUAL RAVEN

14214	40	1
14215	41	1
14216	42	1
14217	43	1
14218	44	1
14219	45	1



- Εξωτερική σόλα διπλής πυκνότητας EVA + TPR.
- Άνω μέρος από συνθετικό δέρμα.

	14220		14224
	14221		14225
	14222		14226
	14223		14227



·Εξωτερική σόλα διπλής πυκνότητας από υψηλής ελαστικότητας EVA + TPR.
·Άνω μέρος από MESH + TPU.

ΠΑΠΟΥΤΣΙ ΑΘΛΗΤΙΚΟ SIROCCO

14220	39	1
14221	40	1
14222	41	1
14223	42	1
14224	43	1
14225	44	1
14226	45	1
14227	46	1

	14228		14233
	14229		14234
	14230		14235
	14231		14236
	14232		



·Εξωτερική σόλα διπλής πυκνότητας από υψηλής ελαστικότητας EVA + TPR.
·Άνω μέρος από FLYKNIT MESH

ΠΑΠΟΥΤΣΙ ΑΘΛΗΤΙΚΟ GLEN

14228	38	1
14229	39	1
14230	40	1
14231	41	1
14232	42	1
14233	43	1
14234	44	1
14235	45	1
14236	46	1

	11126		11131
	11127		11132
	11128		11133
	11129		11134
	11130		11135



•Πιστοποιημένο προϊόν σύμφωνα με το πρότυπο EN ISO 20345: 11.
•Μποτάκι αντιστατικό, με προστασία δακτύλων έως 200 Joule, σόλα ανθεκτική στα ορυκτέλαια και απορρόφηση κραδασμών στη περιοχή της πτέρνας.

ΜΠΟΤΑΚΙ ΑΣΦΑΛΕΙΑΣ S1 "ONTARIO"

11126	38	1
11127	39	1
11128	40	1
11129	41	1
11130	42	1
11131	43	1
11132	44	1
11133	45	1
11134	46	1
11135	47	1

	11188		11192
	11189		11193
	11190		11194
	11191		11195



GET IT NOW

•Πιστοποιημένο προϊόν σύμφωνα με το πρότυπο EN ISO 20347: 12.
•Μποτάκι αντιστατικό, με σόλα ανθεκτική στα ορυκτέλαια και απορρόφηση κραδασμών στη περιοχή της πτέρνας.

ΜΠΟΤΑΚΙ ΑΠΛΟ 01

11188	39	1
11189	40	1
11190	41	1
11191	42	1
11192	43	1
11193	44	1
11194	45	1
11195	46	1

	11339		11343
	11340		11344
	11341		11345
	11342		11346



- Πιστοποιημένο προϊόν σύμφωνα με το πρότυπο EN ISO 20347: 12.
- Παπούτσι αντιστατικό, με σόλα ανθεκτική στα ορυκτέλαια και απορρόφηση κραδασμών στη περιοχή της πτέρνας.

ΠΑΠΟΥΤΣΙ ΑΠΛΟ TORONTO 01 L/S

11339	39	1
11340	40	1
11341	41	1
11342	42	1
11343	43	1
11344	44	1
11345	45	1
11346	46	1

	13868		13873
	13869		13874
	13870		13875
	13871		13876
	13872		13877



GET IT NOW



- Παπούτσι με καλό αερισμό και ενδιάμεσο στρώμα σόλας από ανθεκτικό & εύκαμπτο υλικό Phylon.

ΠΑΠΟΥΤΣΙ ΑΠΛΟ EASY LINE COMO

13868	38	1
13869	39	1
13870	40	1
13871	41	1
13872	42	1
13873	43	1
13874	44	1
13875	45	1
13876	46	1
13877	47	1

	13858		13863
	13859		13864
	13860		13865
	13861		13866
	13862		13867



GET IT NOW



• Παπούτσι με γκρί αντιολισθητική σόλα Rubber ανθεκτική στα πετρελαιοειδή:(GripCell Oil Resistant).

ΠΑΠΟΥΤΣΙ ΑΠΛΟ TREKKING CALDERA

13858	38	1
13859	39	1
13860	40	1
13861	41	1
13862	42	1
13863	43	1
13864	44	1
13865	45	1
13866	46	1
13867	47	1



BELLOTA



ΕΚΘΕΤΗΡΙΟ ΥΠΟΔΗΜΑΤΩΝ

07755	72294	1

	03999		11318
	04005		11319
	04011		11320
	11315		11321
	11316		11322
	11317		12093



- Πιστοποιημένο προϊόν σύμφωνα με το πρότυπο UNE EN ISO 20345:05.
- Μεταλλική προστασία δακτύλων.

Σόλα:

- Εξωτερική αντιολισθητική σόλα SRC διπλής πυκνότητας PU + PU, αντιδιατρητική εσωτερική σόλα.
- Ειδικός σχεδιασμός της εξωτερικής σόλας για πολύ απαιτητικές εργασίες.

Άνω μέρος:

- Δέρμα με δύο διαφορετικά φινιρίσματα, υδροαπωθητικό με μικροίρες.
- Ανθεκτικό στο νερό: απορρόφηση και διείσδυση. •Ανακλαστικό στοιχείο.
- Κολλάρο και γλώσσα με μαξιλαράκι και εργονομικά σχεδιασμένη εσωτερική σόλα για μεγαλύτερη άνεση και προσαρμογή.
- Αφράτη εσωτερική επένδυση Bellota Mesh 3: μέγιστη διαπνοή και άνεση.

ΜΠΟΤΑΚΙ ΑΣΦΑΛΕΙΑΣ 72300 S3

03999	36	1
04005	37	1
04011	38	1
11315	39	1
11316	40	1
11317	41	1
11318	42	1
11319	43	1
11320	44	1
11321	45	1
11322	46	1
12093	47	1

	08515		08519
	08516		08520
	08517		08521
	08518		08522



- Πιστοποιημένο προϊόν σύμφωνα με το πρότυπο UNE EN ISO 20345:05.
- Μεταλλική προστασία δακτύλων.

Σόλα:

- Εξωτερική αντιολισθητική σόλα SRC διπλής πυκνότητας PU + PU, αντιδιατρητική εσωτερική σόλα.
- Ειδικός σχεδιασμός της εξωτερικής σόλας για πολύ απαιτητικές εργασίες.

Άνω μέρος:

- Δέρμα με δύο διαφορετικά φινιρίσματα, υδροαπωθητικό με μικροίρες.
- Ανθεκτικό στο νερό: απορρόφηση και διείσδυση. •Ανακλαστικό στοιχείο.
- Κολλάρο και γλώσσα με μαξιλαράκι και εργονομική εσωτερική σόλα για μεγαλύτερη άνεση και προσαρμογή.
- Αφράτη εσωτερική επένδυση Bellota Mesh 3: μέγιστη διαπνοή και άνεση.

ΜΠΟΤΑΚΙ ΑΣΦΑΛΕΙΑΣ 72302 S3 ΗΛΕΚΤΡΟΣΥΓΚΟΛΛΗΤΩΝ

08515	39	1
08516	40	1
08517	41	1
08518	42	1
08519	43	1
08520	44	1
08521	45	1
08522	46	1

	12086		12089
	12087		12090
	12088		12091



•Πιστοποιημένο προϊόν σύμφωνα με το πρότυπο UNE EN ISO 20345:05. •Μεταλλική προστασία δακτύλων.



Σόλα:

- Εξωτερική αντιολισθητική σόλα SRC διπλής πυκνότητας PU + PU, αντιδιατρητική εσωτερική σόλα.
- Ειδικός σχεδιασμός της εξωτερικής σόλας για πολύ απαιτητικές εργασίες.

Άνω μέρος:

- Δέρμα με δύο διαφορετικά φινιρίσματα, υδροαπωθητικό με μικροϊνες.
- Ανθεκτικό στο νερό: απορρόφηση και διείσδυση. •Ανακλαστικό στοιχείο.
- Κολλάρο και γλώσσα με μαξιλαράκι και εργονομική εσωτερική σόλα για μεγαλύτερη άνεση και προσαρμογή.
- Αφράτη εσωτερική επένδυση Bellota Mesh 3: μέγιστη διαπνοή και άνεση.

ΜΠΟΤΑΚΙ ΑΣΦΑΛΕΙΑΣ 72303 S3

		
12086	40	1
12087	41	1
12088	42	1
12089	43	1
12090	44	1
12091	45	1

	12826		12831
	12827		12832
	12828		12833
	12829		12834
	12830		12835



•Πιστοποιημένο προϊόν σύμφωνα με το πρότυπο UNE EN ISO 20345: 11. •Μεταλλική προστασία δακτύλων.



Σόλα:

- Εξωτερική αντιολισθητική σόλα SRC διπλής πυκνότητας PU + PU, αντιδιατρητική εσωτερική σόλα.
- Σχεδιασμός σόλας που παρέχει ασφάλεια και αντοχή.

Άνω μέρος:

- Δέρμα: δύο διαφορετικά τελειώματα, αναπνεύσιμο και ελαφρύ.
- Κάποια αντίσταση στην υγρασία.
- Αντανακλαστική ταινία μεγαλύτερη ασφάλεια.
- Μαξιλαράκι με επένδυση, εξογκωμένη γλώσσα και εργονομικά διαμορφωμένη εσωτερική σόλα.
- Επένδυση Bellota Mesh: καλύτερη αναπνοή και περισσότερη άνεση.

ΜΠΟΤΑΚΙ ΑΣΦΑΛΕΙΑΣ 72307 S3

		
12826	38	1
12827	39	1
12828	40	1
12829	41	1
12830	42	1
12831	43	1
12832	44	1
12833	45	1
12834	46	1
12835	47	1

	12836		12841
	12837		12842
	12838		12843
	12839		12844
	12840		12845



•Πιστοποιημένο προϊόν σύμφωνα με το πρότυπο UNE EN ISO 20345: 11.
•Μη-μεταλλική προστασία δακτύλων.

Σόλα:

•Εξωτερική αντιολισθητική σόλα SRC διπλής πυκνότητας PU + PU, αντιδιατρητική εσωτερική σόλα.
•Σχεδιασμός σόλας που παρέχει ασφάλεια και αντοχή.

Άνω μέρος:

•Δέρμα: δύο διαφορετικά τελειώματα, αναπνεύσιμο και ελαφρύ.
•Κάποια αντίσταση στην υγρασία.
•Αντανακλαστική ταινία μεγαλύτερη ασφάλεια.
•Μαξιλαράκι με επένδυση, εξογκωμένη γλώσσα και εργονομικά διαμορφωμένη εσωτερική σόλα.
•Επένδυση Bellota Mesh: καλύτερη αναπνοή και περισσότερη άνεση.

ΜΠΟΤΑΚΙ ΑΣΦΑΛΕΙΑΣ 72309 S1P

12836	38	1
12837	39	1
12838	40	1
12839	41	1
12840	42	1
12841	43	1
12842	44	1
12843	45	1
12844	46	1
12845	47	1

	12316		12320
	12317		12321
	12318		12322
	12319		



•Πιστοποιημένο προϊόν σύμφωνα με το πρότυπο UNE EN ISO 20345:05.
•Μεταλλική προστασία δακτύλων.

Σόλα:

•Εξωτερική αντιολισθητική σόλα SRC διπλής πυκνότητας PU + PU, αντιδιατρητική εσωτερική σόλα.
•Ειδικός σχεδιασμός της εξωτερικής σόλας για πολύ απαιτητικές εργασίες.

Άνω μέρος:

•Δέρμα με δύο διαφορετικά φινιρίσματα, υδροαπωθητικό με μικροίνοιες.
•Ανθεκτικό στο νερό: απορρόφηση και διείσδυση. •Ανακλαστικό στοιχείο.
•Κολλάρο και γλώσσα με μαξιλαράκι και εργονομική σόλα για μεγαλύτερη άνεση και προσαρμογή.
•Αφράτη εσωτερική επένδυση Bellota Mesh 3: μέγιστη διαπνοή και άνεση.

ΠΑΠΟΥΤΣΙ ΑΣΦΑΛΕΙΑΣ 72301 S3

12316	40	1
12317	41	1
12318	42	1
12319	43	1
12320	44	1
12321	45	1
12322	46	1

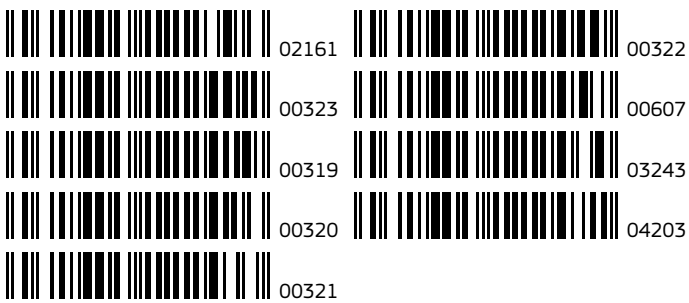

ΓΑΛΟΤΣΑ ΨΗΛΗ ΜΑΥΡΗ

Barcode	Clipboard	Box
02161	39	1
00323	40	1
00319	41	1
00320	42	1
00321	43	1
00322	44	1
00607	45	1
03243	46	1
04203	47	1

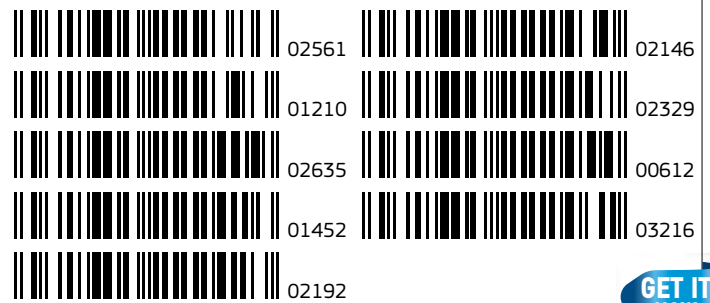

GET IT NOW

ΓΑΛΟΤΣΑ ΚΟΝΤΗ ΜΑΥΡΗ

Barcode	Clipboard	Box
02561	38	1
01210	39	1
02635	40	1
01452	41	1
02192	42	1
02146	43	1
02329	44	1
00612	45	1
03216	46	1



ΓΑΛΟΤΣΑ ΑΣΦΑΛΕΙΑΣ S5 PVC 20326

Barcode	Clipboard	Cube
05938	41	1
04993	42	1
04994	43	1
04995	44	1
04996	45	1



ΓΑΛΟΤΣΑ PVC ΠΡΑΣΙΝΗ

Barcode	Clipboard	Cube
04544	40	10
00355	41	10
02332	42	10
03178	43	10
03179	44	10
04554	45	10
05621	46	10



ΓΑΛΟΤΣΑ ΓΟΦΟΥ ΕΛΑΣΤΙΚΗ

Barcode	Clipboard	Cube
06254	41	1
03281	42	1
03282	43	1
03280	44	1
03283	45	1



Ανακαλύψτε
**την ανανεωμένη
ιστοσελίδα μας**

www.patco.gr



ΑΦΟΙ ΒΛΑΧΟΥ Ο.Ε.

Οδός Β3, Ο.Τ. 32, ΒΙ.ΠΕ. ΠΑΤΡΩΝ Τ.Κ. 25200

Τηλ. 2610647455, 2610647457, 2610647179, Fax: 2610647005

